

Panasonic®

Operating Instructions

Telephone Answering System

Model No. **KX-TS620**



Model shown is KX-TS620W

This unit is compatible with Caller ID. To use this feature, you must subscribe to the appropriate service offered by your service provider.

Please read these Operating Instructions before using the unit and save for future reference.

Panasonic World Wide Web address: <http://www.panasonic.com>
for customers in the USA or Puerto Rico

For assistance, please visit <http://www.panasonic.com/phonehelp>

Table of Contents

Introduction

Accessory Information..... 3

Preparation

Important Safety Instructions 4

Location of Controls 6

Display..... 8

Settings

Connecting the Handset/AC Adaptor/
Telephone Line Cord 9

Connecting a Communication
Device 10

Programming Summary 11

Time and Date..... 12

Display Language..... 13

Dialing Mode 13

LCD Contrast..... 14

Ringer Volume..... 14

Caller ID Number Auto Edit 14

Time Adjustment
(Caller ID subscribers only) 15

Preparing the Answering System

Greeting Message 16

Programming Summary for the

Answering System..... 18

Number of Rings 19

Caller's Recording Time 20

Screening Calls 20

Making/Answering Calls

Making Calls..... 21

Answering Calls..... 23

Caller ID Service

Private Name Display 24

Viewing the Caller List..... 25

Calling Back from the Caller List 27

Editing the Caller's

Phone Number 27

Storing Caller List Information
in the Phonebook 28

Storing Caller List Information in
the Direct Dial memory..... 29

Erasing Caller List Information 30

Phonebook

Storing Names and Numbers in the
Phonebook 31

Dialing from the Phonebook..... 33

Chain Dial..... 34

Editing 35

Erasing 35

Direct Dial (M1, M2, M3)

Storing Names and Numbers in the
Direct Dial memory 36

Dialing a Stored Number from the
Direct Dial memory 37

Special Features

Temporary Tone Dialing
(For Rotary or Pulse
Service Users)..... 38

How to Use the PAUSE Button
(For PBX Line/Long
Distance Calls) 38

Muting Your Conversation..... 38

For Call Waiting Service Users..... 39

Setting Hold Music to ON/OFF 39

FLASH Button 40

Setting the Password..... 41

Call Restriction 42

Answering System

Automatic Answering Operation 43

Setting the Unit to Answer Calls 43

Listening to Messages..... 44

Recording Your Telephone
Conversation..... 45

Erasing Messages..... 46

Remote Operation from a
Touch Tone Phone..... 47

Remote Code 48

Voice Menu 49

Direct Remote Operation..... 50

Useful Information

Wall Mounting 52

Optional Headset..... 53

Troubleshooting 54

Specifications 56

FCC and Other Information 57

Index..... 59

Warranty 60

Customer services..... 62

Please read **IMPORTANT SAFETY INSTRUCTIONS** on page 4 before use.
Read and understand all instructions.

Thank you for purchasing your new Panasonic telephone answering system.

We recommend keeping a record of the following information for future reference

Serial No. _____

Date of purchase _____

(found on the bottom of the unit)

Name and address of dealer _____

Attach your purchase receipt here.

Accessory Information

To order replacement accessories, call 1-800-332-5368.

TTY users (hearing or speech impaired user) can call 1-866-605-1277.

AC Adaptor (p. 9) : one

Order No.

PQLV205 or

PQLV207

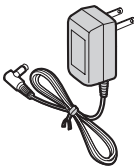

Handset Cord (p. 9) : one

Order No.

PQJA212M (White)

PQJA212N (Black)

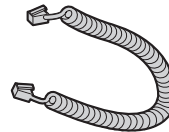

Handset (p. 9) : one

Order No.

PQJXF0102Z (White)

PQJXF0101Z (Black)

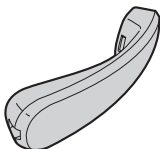

Telephone Line Cord (p. 9) : one

Order No.

PQJA10075Z



Important Safety Instructions

When using this unit, basic safety precautions should always be followed to reduce the risk of fire, electric shock, or personal injury.

1. Read and understand all instructions.
2. Follow all warnings and instructions marked on this unit.
3. Unplug this unit from power outlet before cleaning. Do not use liquid or aerosol cleaners. Use a damp cloth for cleaning.
4. Do not use this unit near water, for example near a bathtub, washbowl, kitchen sink, etc.
5. Place the unit securely on a stable surface. Serious damage and/or injury may result if the unit falls.
6. Do not cover slots and openings on the unit. They are provided for ventilation and protection against overheating. Never place the unit near radiators, or in a place where proper ventilation is not provided.
7. Use only the power source marked on the unit. If you are not sure of the type of power supplied to your home, consult your dealer or local power company.
8. Do not place objects on the power cord. Install the unit where no one can step or trip on the cord.
9. Do not overload power outlets and extension cords. This can result in the risk of fire or electric shock.
10. Never push any objects through slots in this unit. This may result in the risk of fire or electric shock. Never spill any liquid on the unit.
11. To reduce the risk of electric shock, do not disassemble this unit. Take the unit to an authorized service center when service is required. Opening or removing covers may expose you to

dangerous voltages or other risks. Incorrect reassembly can cause electric shock when the unit is subsequently used.

12. Unplug this unit from the power outlet and refer servicing to an authorized service center when the following conditions occur:
 - A. When the power supply cord or plug is damaged or frayed.
 - B. If liquid has been spilled into the unit.
 - C. If the unit has been exposed to rain or water.
 - D. If the unit does not work normally by following the operating instructions. Adjust only controls covered by the operating instructions. Improper adjustment may require extensive work by an authorized service center.
 - E. If the unit has been dropped or physically damaged.
 - F. If the unit exhibits a distinct change in performance.
13. During thunderstorms, avoid using telephones except cordless types. There may be a remote risk of an electric shock from lightning.
14. Do not use this unit to report a gas leak, when in the vicinity of the leak.

SAVE THESE INSTRUCTIONS

WARNING:

TO PREVENT FIRE OR SHOCK HAZARD, DO NOT EXPOSE THIS PRODUCT TO RAIN OR ANY TYPE OF MOISTURE.

CAUTION: **Installation**

- Never install telephone wiring during a lightning storm.
- Never install telephone jacks in wet locations unless the jack is specifically designed for wet locations.
- Never touch the uninsulated telephone wires or terminals unless the telephone line has been disconnected at the network interface.
- Use caution when installing or modifying telephone lines.
- Do not touch the plug with wet hands.

General

- Use only the AC adaptor included with this product noted on page 9.
- Do not connect the AC adaptor to any AC outlet other than a standard AC 120 V outlet.
- This product is unable to make calls when:
 - the call bar feature is turned on (only phone numbers stored in the unit as emergency numbers can be called).
- Care should be taken so that objects do not fall onto, and liquids are not spilled into the unit. Do not subject this unit to excessive smoke, dust, mechanical vibration or shock.

Environment

- The product should be kept free from excessive smoke, dust, high temperature and vibration.
- The product should not be exposed to direct sunlight.
- Do not place heavy objects on top of the product.
- When you leave the product unused for a long period of time, unplug the product from the power outlet.
- The product should be kept away from heat sources such as heaters, kitchen stoves, etc. It should not be placed in rooms where the temperature is less than 5°C (41°F) or greater than 40°C (104°F). Damp basements should also be avoided.

- The AC adaptor is used as the main disconnect device. Ensure that the AC outlet is installed near the unit and is easily accessible.

Routine care

- Wipe the outer surface of the product with a soft moist cloth. Do not use benzine, thinner or any abrasive powder.

WARNING:

- To prevent the risk of fire or electrical shock, do not expose this product to rain or any type of moisture.
- Unplug this unit from power outlets if it emits smoke, an abnormal smell or makes unusual noise. These conditions can cause fire or electric shock. Confirm that smoke has stopped and contact the Panasonic Call Center at 1-800-211-PANA (1-800-211-7262).

Location of Controls

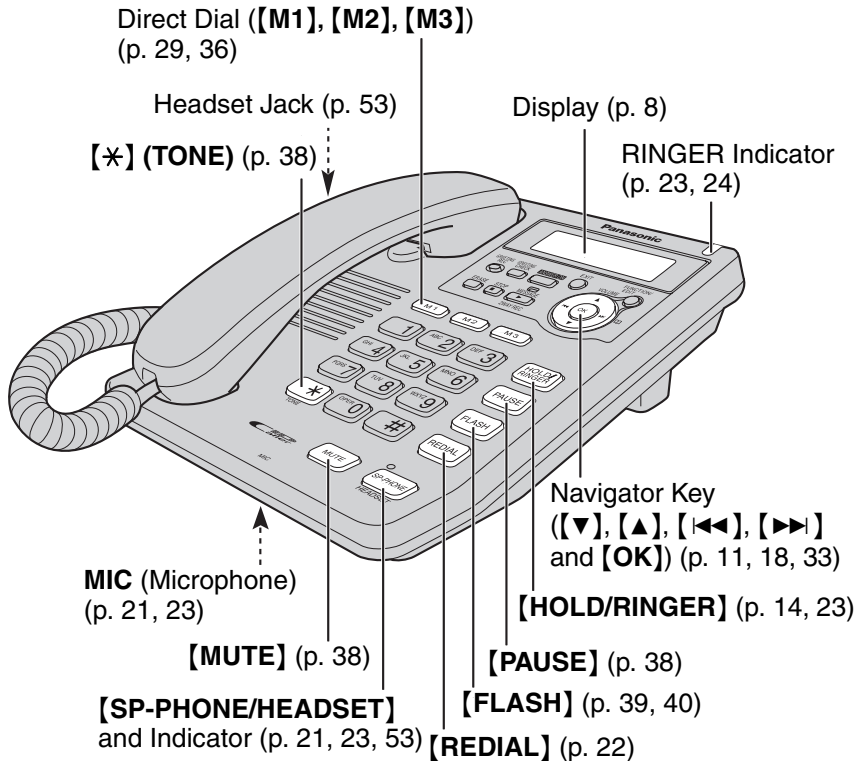

How to use the Navigator key and **[OK]** button

This key has five active areas that are indicated by arrows and **[OK]**.

- Pressing the **[▲]** and **[▼]** arrows allows you to enter the Caller List and scroll through the function menu, the Caller List and the Phonebook list.
- Pressing the **[◀◀]** and **[▶▶]** arrows allows you to:
 - enter the Phonebook list.
 - move the cursor when entering items.
 - to repeat and skip a message during playback.
- The **[OK]** button is used to select or confirm your menu choices.



Throughout these Operating Instructions, the navigator key is indicated by the arrows **[▼]**, **[▲]**, **[◀◀]**, **[▶▶]** and **[OK]**.

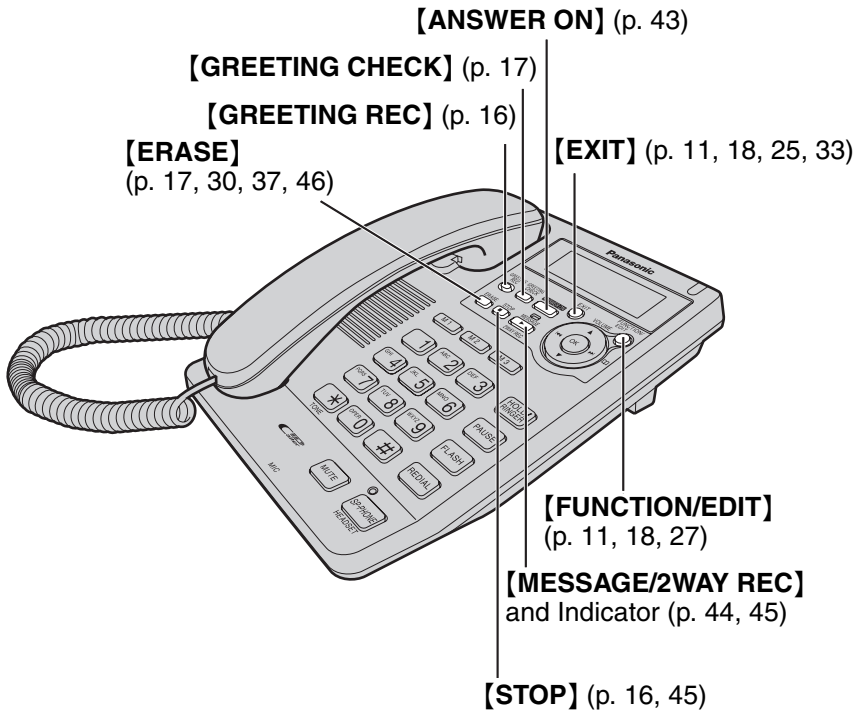

Display



(This display shows all the possible configurations.)

12:34AM DEC.31
10 missed calls
5 messages

When the handset is on the cradle, the AC adaptor is connected and the SP-PHONE/HEADSET indicator light is off, the display shows the current time and date, the number of new calls and the number of recorded messages.

12:00AM DEC.31
0 message
☎

If “☎” flashes on the display, the clock needs adjustment (p. 12, 13).

12:34AM DEC.15
01-06-35

During a conversation, the display shows the length of the call (Example: 1 hour, 6 minutes and 35 seconds).

SMITH, JACK
1-111-444-7777
11:50AM NOV.24

This is a display from the Caller List. The display shows:

- the caller's name and number,
- the time and date of the call (Example: Nov. 24, 11:50 AM).

: The unit enters in the Phonebook (p. 31).

: The unit plays music during the hold for a caller (p. 39).

: The second call has been received while talking (p. 39).

: **[MUTE]** was pressed during a conversation (p. 38).

: The ringer is set to off (p. 14).

: **[REDIAL]** was pressed while the handset is on the cradle and the SP-PHONE/HEADSET indicator is off (p. 22).

: **[PAUSE]** was pressed while dialing or storing phone numbers.

: **[FLASH]** was pressed while storing phone numbers.

Connecting the Handset/AC Adaptor/Telephone Line Cord

After line connection, lift the handset to check for a dial tone.

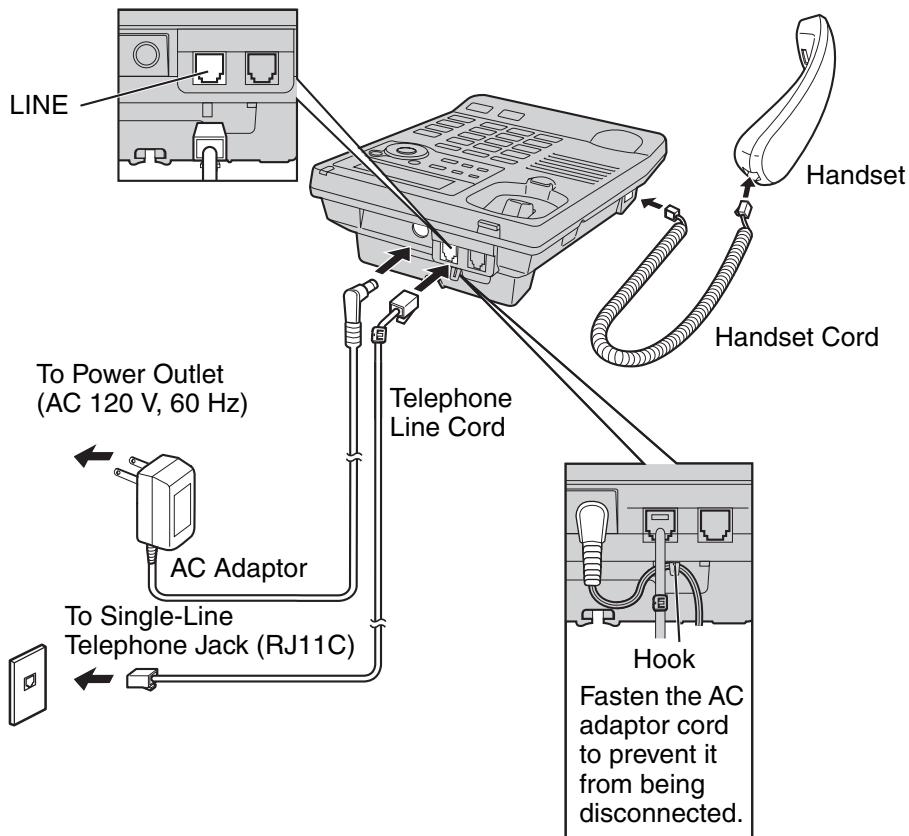

- USE ONLY WITH Panasonic AC ADAPTOR PQLV205 or PQLV207.
- Use only a Panasonic Handset for the KX-TS620W or KX-TS620B.
- The AC adaptor must remain connected at all times. (It is normal for the adaptor to feel warm during use.)
- The AC adaptor should be connected to a vertically oriented or floor-mounted AC outlet. Do not connect the AC adaptor to a ceiling-mounted AC outlet as the weight of the adaptor may cause it to become disconnected.
- If your unit is connected to a PBX which does not support Caller ID services, you cannot access those services.

If you subscribe to a DSL service:

- Please attach a noise filter (contact your DSL provider) to the telephone line between the unit and the telephone line jack in the event of the following:
 - Noise is heard during conversations.
 - Caller ID feature (p. 24) does not function properly.

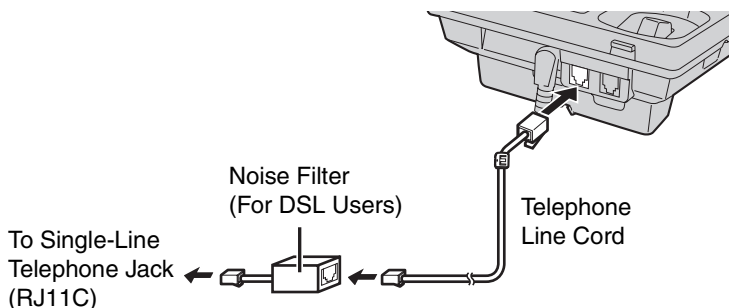

Connecting a Communication Device

If you connect a communication device (computer, modem, fax, etc.) to the telephone line, you can connect it through this unit using the DATA jack.

After connecting the handset, AC adaptor and telephone line cord (p. 9), connect the communication device telephone line cord to the DATA jack.

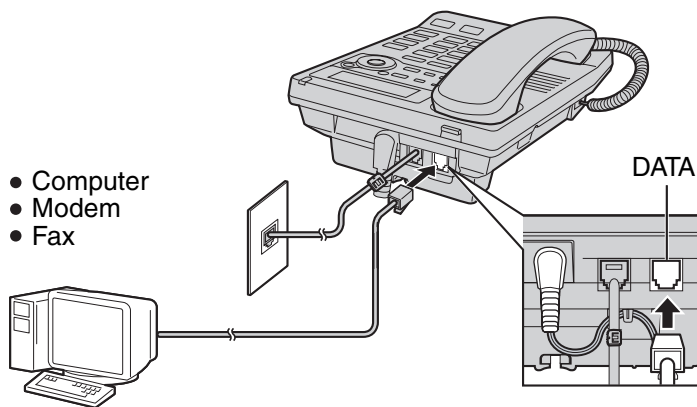

- Make sure the communication device is not in use before using this unit (making calls, storing phone numbers in memory etc.) or the communication device may not operate properly.

Programming Summary

You can program the following functions. The display shows the programming instructions. See the corresponding pages for function details.

Make sure that the handset is on the cradle, the AC adaptor is connected and the SP-PHONE/HEADSET indicator light is off.

Press **[FUNCTION/EDIT]**.

<Function menu>*

Save phonebook ?	To store names and phone numbers in memory
Save M1, M2, M3 ?	(p. 31, 36).
Program ?	
Set answering ?..	To program answering system functions (p. 18).
Set clock ?.....	To adjust the time and date (p. 12).
Change language?..	To select the display language (p. 13).

Scroll to "Program ?" by pressing **[▼]** or **[▲]** and press **[OK]** (Yes key).

<Function menu>*

Change password?	To change the password for the call restriction (p. 41).
Call restrict ?..	To set the call restriction feature (p. 42).
Set flash time ?	To select the flash time (p. 40).
Set dial mode ?..	To select the dialing mode (p. 13).
LCD contrast ?..	To select the LCD contrast (p. 14).
Set hold music ?	To set the music during hold (p. 39).
Set auto edit ?..	To set area code and edit pattern for incoming call
	(p. 14).
Time adjustment?	To set the auto time adjustment (p. 15).

During programming

* To select a desired function item, scroll through the items by pressing **[▼]** or **[▲]**. Then press **[OK]** to go to the next step.

- "-----" indicates the end of the function menu.
- You can exit the programming mode any time by pressing **[EXIT]**.
- If you do not press any buttons for 60 seconds, the unit will exit the programming mode.

Time and Date

You can select AM/PM or 24-hour clock by programming.

Voice Time/Day Stamp:

During playback, a synthesized voice will announce the time and day that each message was recorded.

Make sure that the handset is on the cradle, the AC adaptor is connected and the SP-PHONE/HEADSET indicator light is off.

- 1** Press **[FUNCTION/EDIT]**.
- 2** Scroll to "Set clock ?" by pressing **[▼]** or **[▲]** and press **[OK]** (Yes key).
- 3** Press **[OK]** (Next key). Enter the current year. (Example: To set 2006, enter "06".)
 - You can set the year 2000 to 2099.

Enter year
2006
▼▲ [OK]=Next

- 4** Press **[OK]** (Next key).
- 5** Enter the current time (hour and minute) using a 4-digit number. (Example: To set 9:30, enter "0930".)
 - For AM/PM setting: Enter numbers between 0100 and 1259.
 - For 24-hour clock: Enter numbers between 0000 and 2359.

Enter time
09:30
▼▲ [OK]=Next

- 6** Press **[OK]** (Next key).
 - If numbers between 0000 and 0059, or 1300 and 2359 are entered, the time will automatically be set using the 24-hour clock. Go to the step 9.

#=AM/PM/24H
AM
▼▲ [OK]=Next

- 7** Press **[#]** to select "AM", "PM" or 24-hour clock.

Display Option

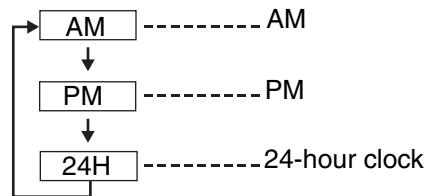

- Each time you press **[#]**, the selection will change on the display.

- 8** Press **[OK]** (Next key).
- 9** Enter the current day and month using a 4-digit number. (Example: To set Dec. 27, enter "1227".)

Enter month/day
12/27
▲ [OK]=Save

- 10** Press **[OK]** (Save key).
 - A long beep sounds.
 - The clock starts working.
 - The display will return to step 2. To exit the programming mode, press **[EXIT]** or wait for 60 seconds.
 - You can go back to the previous screen by pressing **[▲]**, when setting the time and date (steps 3 through 9).
 - If 3 beeps sound when entering the time and date, the time and date entered are not correct. Enter the correct time and date.

After recover from power failure, “⊖” will flash. Readjust the time and date.

For Caller ID service users (p. 24)

If a time display service is available with the Caller ID service:

- The Caller ID information will re-set the clock after the ring if the adjusted time and/or date is incorrect and the Time Adjustment set to ON (p. 15). If the time/date has not previously been set, the Caller ID information will not adjust the clock.

Display Language

You can select “English” or “Español” as the display language.

Your phone comes from the factory set to “English”.

Make sure that the handset is on the cradle, the AC adaptor is connected and the SP-PHONE/HEADSET indicator light is off.

- 1 Press **[FUNCTION/EDIT]**.
- 2 Scroll to “Change language?” by pressing **[▼]** or **[▲]**.
- 3 Press **[OK]** (Yes key).

```
Language
: English
▼▲ [OK]=Save
```

- 4 Select “English” or “Español” by pressing **[▼]** or **[▲]**.
- 5 Press **[OK]** (Save key).
 - A long beep sounds.
 - The display will return to step 2. To exit the programming mode, press **[EXIT]** or wait for 60 seconds.

- You can exit the programming mode any time by pressing **[EXIT]**.

Dialing Mode

If you have touch tone service, set to Tone. If rotary or pulse service is used, set to Pulse. Your phone default setting is Tone.

Make sure that the handset is on the cradle, the AC adaptor is connected and the SP-PHONE/HEADSET indicator light is off.

- 1 Press **[FUNCTION/EDIT]**.
- 2 Scroll to “Program ?” by pressing **[▼]** or **[▲]** and press **[OK]** (Yes key).
- 3 Scroll to “Set dial mode ?” by pressing **[▼]** or **[▲]** and press **[OK]** (Yes key).
- 4 Select “Pulse” or “Tone” by pressing **[▼]** or **[▲]**.
(Example: “Tone” is selected.)

```
Dial mode
: Tone
▼▲ [OK]=Save
```

- 5 Press **[OK]** (Save key).
 - A long beep sounds.
 - The display will return to step 3. To exit the programming mode, press **[EXIT]** or wait for 60 seconds.
- You can exit the programming mode any time by pressing **[EXIT]**.

LCD Contrast

You can select the LCD contrast level from 1 to 4 by programming. To make the display clearer, set to high level. Your phone default setting is 2.

Make sure that the handset is on the cradle, the AC adaptor is connected and the SP-PHONE/HEADSET indicator light is off.

- 1 Press **[FUNCTION/EDIT]**.
- 2 Scroll to "Program ?" by pressing **[▼]** or **[▲]** and press **[OK]** (Yes key).
- 3 Scroll to "LCD contrast ?" by pressing **[▼]** or **[▲]** and press **[OK]** (Yes key).
 - The current setting is displayed.



LCD contrast
Low■■■■■ High
▼▲ [OK]=Save

- 4 Select the desired contrast by pressing **[▼]** or **[▲]**, then press **[OK]** (Save key).
 - A long beep sounds.
 - The display will return to step 3. To exit the programming mode, press **[EXIT]** or wait for 60 seconds.
- You can exit the programming mode any time by pressing **[EXIT]**.

Ringer Volume

Make sure that the AC adaptor is connected and the unit is not being used.

To select HIGH (default), MID or LOW, press [HOLD/RINGER].

- Each time you press the button, the ringer volume will change and the selected volume will ring.

To turn the ringer OFF, press and hold [HOLD/RINGER] until 2 beeps sound.

- "🔕" is displayed.

To turn the ringer ON, press [HOLD/RINGER].

- The ringer will sound at the HIGH level.

Caller ID Number Auto Edit

Once you call back an edited number, this unit will remember Area Code and Format of the Edited Number. Next time when someone calls from the same Area Code, caller information will be customized by the unit as follows:

- When the call is being received, the Caller ID number will be displayed in the same Format as the Edited Number.
- After the call is ended, the telephone number of the caller, when reviewed from the Caller list, will be displayed in the same Format as the Edited Number.

For example, you can use this feature to set the unit to ignore the area code of callers in your area code, so that you can call these local numbers using caller information without dialing the area code. To activate this feature, you must edit an item in the caller list, then call this number. After that, phone numbers from that caller's area code are edited automatically. This feature can be turned on or off (p. 15). Your phone default setting is ON.

To turn Caller ID Number Auto Edit On or OFF.

- 1** Press **[FUNCTION/EDIT]**.
- 2** Scroll to "Program ?" by pressing **[▼]** or **[▲]**. Press **[OK]** (Yes key).
- 3** Scroll to "Set auto edit ?" by pressing **[▼]** or **[▲]**.
- 4** Press **[OK]** (Yes key).
- 5** Select "On" or "Off" by pressing **[▼]** or **[▲]**.

Auto edit
: On
▼▲ [OK]=Save

- 6** Press **[OK]** (Save key).
 - A long beep sounds.
 - The display will return to step 3. To exit the programming mode, press **[EXIT]** or wait for 60 seconds.
- Phone numbers from the 4 most recently edited area codes are automatically edited.
 - If you fail to reach your destination when making a call, the phone number you dialed might have an incorrect pattern. Edit the phone number with another pattern (p. 27).
 - When this feature is turned off, the unit will still be able to display Caller ID, but incoming Caller ID numbers will not be automatically edited.
 - If you move to another area, you may need to turn this feature off to erase the previously edited area codes. To use this feature again, turn it on and reprogram the area codes you want to edit once again.

Time Adjustment (Caller ID subscribers only)

Using this feature, the unit's date and time setting will be automatically adjusted when caller information is received. You can set the auto time adjustment by programming. Your phone default setting is ON.

Make sure that the handset is on the cradle, the AC adaptor is connected and the SP-PHONE/HEADSET indicator light is off.

- 1** Press **[FUNCTION/EDIT]**.
- 2** Scroll to "Program ?" by pressing **[▼]** or **[▲]** and press **[OK]** (Yes key).
- 3** Scroll to "Time adjustment?" by pressing **[▼]** or **[▲]** and press **[OK]** (Yes key).
- 4** Select "On" or "Off" by pressing **[▼]** or **[▲]**.
- 5** Press **[OK]** (Save key).
 - A long beep sounds.
 - The display will return to step 3. To exit the programming mode, press **[EXIT]** or wait for 60 seconds.
 - To use this feature, set the date and time in advance (p. 12).

Greeting Message

You can record a personal greeting message of **up to 1 minute**. If a greeting message is not recorded, one of the two pre-recorded greetings will be played when a call is received (p. 17).

All messages (incoming, etc.) are stored in flash memory (p. 17). The **recording time is about 15 minutes**.

We recommend you record a **brief greeting message** (see sample on next page) in order to leave more time for recording new messages.

Make sure that the handset is on the cradle, the AC adaptor is connected and the SP-PHONE/HEADSET indicator light is off.

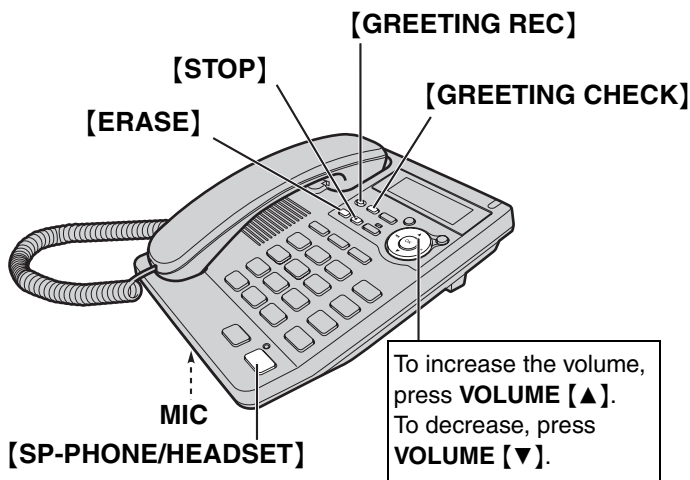

To record a greeting message

- 1 Press **[GREETING REC]**.
 - The unit announces "To record greeting, press RECORD again".
- 2 Within 10 seconds, press **[GREETING REC]** again.
- 3 After the long beep, talk clearly, about 20 cm away from the **MIC** (microphone).
 - The display will show the recording time.
 - If you record for over 1 minute, the unit will automatically stop recording.
- 4 When finished, press **[STOP]**.
 - To change the message, start again from step 1.

Greeting record
00-30

Greeting message sample

“Hello, this is (your name and/or number). Sorry I cannot take your call. Please leave a message after the beep. Thank you.”

- If the unit starts to ring while recording a greeting message, press **[SP-PHONE/HEADSET]** or lift the handset off the unit to answer the call. The recording will stop. Start again from the beginning after hanging up.

To check the recorded greeting message

Press **[GREETING CHECK]**.

- The greeting message will be played.

To erase the recorded greeting message

Press **[GREETING CHECK]**, and then press **[ERASE]** while the message is being played.

- The unit will answer a call with a pre-recorded greeting.

Pre-recorded greeting message

If you do not record a greeting message (p. 16), one of two messages will be played when a call is received, depending on the caller's recording time (p. 20).

To check the pre-recorded greeting, press [GREETING CHECK].

A pre-recorded greeting will be played as follows:

- When the recording time is set to “1 minute”, “2 minutes” or “3 minutes”:

“Hello, we are not available now. Please leave your name and phone number after the beep. We will return your call.”

- When the recording time is set to “Greeting only”:

“Hello, we are not available now. Please call again. Thank you for your call.”

Flash Memory Message Backup

Messages are stored indefinitely on a “flash memory” IC chip and will not be affected by power failures. All messages are saved until you erase them.

Programming Summary for the Answering System

You can program the following functions. The display shows the programming instructions. See the corresponding pages for function details.

Make sure that the handset is on the cradle, the AC adaptor is connected and the SP-PHONE/HEADSET indicator light is off.

Press **[FUNCTION/EDIT]**.



Scroll to “**Set answering ?**” by pressing **[▼]** or **[▲]** and press **[OK]** (Yes key).



<Function menu>*

Remote code ?	To set the remote code (p. 48).
Number of rings ?	To select the number of rings (p. 19).
Recording time ?	To select the caller's recording time (p. 20).
Call screening ?	To set the call screening feature (p. 20).

During programming

* To select a desired function item, scroll through the items by pressing **[▼]** or **[▲]**. Then press **[OK]** (Yes key) to go to the next step.

- “-----” indicates the end of the function menu.
- You can exit the programming mode any time by pressing **[EXIT]**.
- If you do not press any buttons for 60 seconds, the unit will exit the programming mode.

Number of Rings

You can select the number of times the unit rings before the answering system answers a call, from “2” to “7” or “Toll saver*¹”. Your phone default setting is “4”.

Make sure that the handset is on the cradle, the AC adaptor is connected and the SP-PHONE/HEADSET indicator light is off.

- 1** Press **[FUNCTION/EDIT]**.
- 2** Scroll to “Set answering ?” by pressing **[▼]** or **[▲]**, then press **[OK]** (Yes key).
- 3** Scroll to “Number of rings?” by pressing **[▼]** or **[▲]**.
- 4** Press **[OK]** (Yes key).
 - The current setting is displayed.

Number of rings : 4 ▼▲ [OK]=Save
--

- 5** Select the number of rings by pressing **[▼]** or **[▲]**.
 - You can also select the number of rings by pressing dialing buttons **[2]** to **[7]** or **[0]** (Toll saver*¹).

- 6** Press **[OK]** (Save key).
 - A long beep sounds.
 - The display will return to step 3. To exit the programming mode, press **[EXIT]** or wait for 60 seconds.
- You can exit the programming mode any time by pressing **[EXIT]**.

* Toll Saver

When you call the unit from a touch tone telephone:

If the unit answers on the 2nd ring, there is at least one new message. If the unit answers on the 4th ring, there are no new messages.

Hang up when you hear the 3rd ring. This will save you the toll charge for the call.

Caller's Recording Time

You can select "1 minute", "2 minutes", "3 minutes" or "Greeting only" for the caller's recording time. Your phone default setting is "3 minutes".

Make sure that the handset is on the cradle, the AC adaptor is connected and the SP-PHONE/HEADSET indicator light is off.

- 1 Press **[FUNCTION/EDIT]**.
 - 2 Scroll to "Set answering ?" by pressing **[▼]** or **[▲]** and press **[OK]** (Yes key).
 - 3 Press **[▼]** or **[▲]** to select "Recording time ?" and press **[OK]** (Yes key).
 - The current setting is displayed.

Recording time
: 3min.
▼▲ [OK]=Save
 - 4 Select the recording time by pressing **[▼]** or **[▲]**.
 - You can also select the recording time by pressing dialing buttons **[1]** (1 minute), **[2]** (2 minutes), **[3]** (3 minutes) or **[0]** (Greeting only).
 - 5 Press **[OK]** (Save key).
 - A long beep sounds.
 - The display will return to step 3. To exit the programming mode, press **[EXIT]** or wait for 60 seconds.
- You can exit the programming mode any time by pressing **[EXIT]**.

If you select "Greeting only", the unit will answer a call with the greeting message, and then hang up. The unit will not record any incoming messages.

Screening Calls

While a caller is leaving a message, you can listen to the call through the unit's speaker. Your phone default setting is ON.

Make sure that the handset is on the cradle, the AC adaptor is connected and the SP-PHONE/HEADSET indicator light is off.

- 1 Press **[FUNCTION/EDIT]**.
- 2 Scroll to "Set answering ?" by pressing **[▼]** or **[▲]** and press **[OK]** (Yes key).
- 3 Press **[▼]** or **[▲]** to select "Call screening ?" and press **[OK]** (Yes key).
- 4 Select "On" or "Off" by pressing **[▼]** or **[▲]** and press **[OK]** (Save key).
 - A long beep sounds.
 - The display will return to step 3. To exit the programming mode, press **[EXIT]** or wait for 60 seconds.

Making Calls

You can make a call by simply lifting the handset. To hang up, place the handset on the cradle.

Using the speakerphone

1 Press **[SP-PHONE/HEADSET]**, then dial a phone number.

OR

Dial a phone number, then press **[SP-PHONE/HEADSET]**.

- The indicator lights.
- The dialed number is displayed.
- After a few seconds, the display will show the length of the call.
- If you have misdialed, hang up and start again from step 1.



12:34PM NOV. 24
1234567890



12:34PM NOV. 24
00-00-02

2 When the other party answers, talk into the **MIC** (microphone).

3 To hang up, press **[SP-PHONE/HEADSET]**.

- The indicator light goes out.
- After a few seconds, the display will change.

During speakerphone operation

For best performance, please note the following:

- Talk alternately with the other party in a quiet room.
- If the other party has difficulty hearing you, press **VOLUME [▼]** to decrease the speaker volume.
- You can switch to the handset by lifting it up. To switch back to the speakerphone, press **[SP-PHONE/HEADSET]**.

To redial the last number dialed

Using the handset: Lift the handset → press **[REDIAL]**.
OR

Press **[REDIAL]** → Lift the handset.

Using the speakerphone: Press **[SP-PHONE/HEADSET]** → press **[REDIAL]**.
OR

Press **[REDIAL]** → press **[SP-PHONE/HEADSET]**.

To redial using the redial list (Memory Redial)

The last 20 phone numbers dialed are stored in the redial list.

1 Press **[REDIAL]**.

- The last dialed number and “**☎**” are displayed.
- When the number dialed has been stored in the Phonebook or Direct Dial memory, the name is also displayed.

2 Scroll to the desired number by pressing **[▼]** or **[▲]**.

- You can also scroll through the list by pressing **[REDIAL]**.
- To exit the list, press **[EXIT]**.

3 Lift the handset or press **[SP-PHONE/HEADSET]**.

- To erase an item, repeat steps 1 and 2, and press **[ERASE]**.
 - If “**No items stored**” is displayed, the list is empty.
-

To adjust the handset volume (4 levels) or the speaker volume (8 levels) while talking

To increase, press **VOLUME [▲]**. To decrease, press **VOLUME [▼]**.

Example: Handset volume level: 2



“**■ ■**” shows one level.

Example: Speaker volume level: 3



“**■ ■ ■**” shows one level.

- The display shows the volume level for a few seconds.

To put a call on hold

Press **[HOLD/RINGER]** during a conversation.

- The SP-PHONE/HEADSET indicator flashes.
- If using the handset, you can place it on the cradle.
- During the hold, the caller will hear music. For canceling music, see page 39.

To release the hold

If the handset is on the cradle, lift the handset.

If the handset is off the cradle, press **[HOLD/RINGER]**.

If using the speakerphone, press **[SP-PHONE/HEADSET]**.

- If another phone is connected on the same line, you can also release the hold by lifting its handset.

Answering Calls

When a call is received, the unit rings, the RINGER indicator flashes quickly and “**Incoming call**” is displayed. You can answer a call by simply lifting the handset. If you subscribe to a Caller ID service, the calling party’s information will be displayed when the unit is ringing (p. 24).

Using the speakerphone

1 Press **[SP-PHONE/HEADSET]**.

- The indicator lights.

2 Talk into the **MIC** (microphone).

3 To hang up, press **[SP-PHONE/HEADSET]**.

- The indicator light goes out.

- When the ringer volume is set to OFF (p. 14), the unit will not ring.
- The RINGER indicator will flash when
 - a telephone number is dialed in PULSE mode, or
 - someone picks up or hangs up another phone connected to the same phone line.This is normal.

This unit is compatible with a Caller ID service offered by your telephone company. If you subscribe to a Caller ID service, the calling party's information will be displayed when the unit is ringing.

The unit can record information of up to 50 incoming calls, including the time and date received in the Caller List. The Caller List information is sorted from the most recent to the oldest call. When the 51st call is received, the oldest call is deleted.

Using the list, you can automatically call back a caller. You can store the callers' numbers from the Caller List into the Phonebook or the Direct Dial memory.

When a second call is received while talking, the new caller's phone number will be displayed (p. 39).

How caller information is displayed when a call is received

The display shows the caller's name and phone number when the unit is ringing.*

- After you answer the call, the display will show the length of the call.

SMITH, JACK
1-111-444-7777



The RINGER indicator will flash quickly when a call is being received.

*Private name display

If you receive a call from one of the same phone numbers stored in the Phonebook or Direct Dial memory, the caller's name will be displayed.

- To use this function, names and phone numbers must be stored in the Phonebook or Direct Dial memory (p. 31, 36).
- Caller information will not be displayed in the following cases:
 - If the caller dialed from an area which does not provide a Caller ID service, the display will show "**Out of area**".
 - If the caller has requested not to display his/her information, the display will show "**Private caller**".
 - If a long distance call is identified and the caller's name and/or number cannot be received, the display will show "**Long distance**".
- If your unit is connected to a PBX which does not support Caller ID services, you cannot access those services.
- If you receive a call with the Caller ID information while viewing the Caller List, the redial list, the Phonebook list or the Direct Dial memory, while programming or while playing back the message, the caller's information may not be displayed.
- If the name and the time/date display service is available in your area, the display will show caller's names and the time/date the calls were received. For further information, please contact your telephone company.

ROBINSON, TINA
1-111-321-4444

Viewing the Caller List

If you have received 10 missed calls, the number of missed calls will be displayed as shown, while the unit is not in use.

12:34AM MAY.21 10 missed calls 0 message
--

To check who has called, follow the steps below.

- 1** Press [▼] or [▲] to enter the Caller List.
- 2** To search from the most recent call, press [▼].
 - To search from the oldest call, press [▲].
 - To scroll between callers, press [▼] or [▲].
- 3** To exit the Caller List, press [EXIT].

• If “No items stored” is displayed in step 1, the Caller List is empty.

Example: When you search from the most recent call:

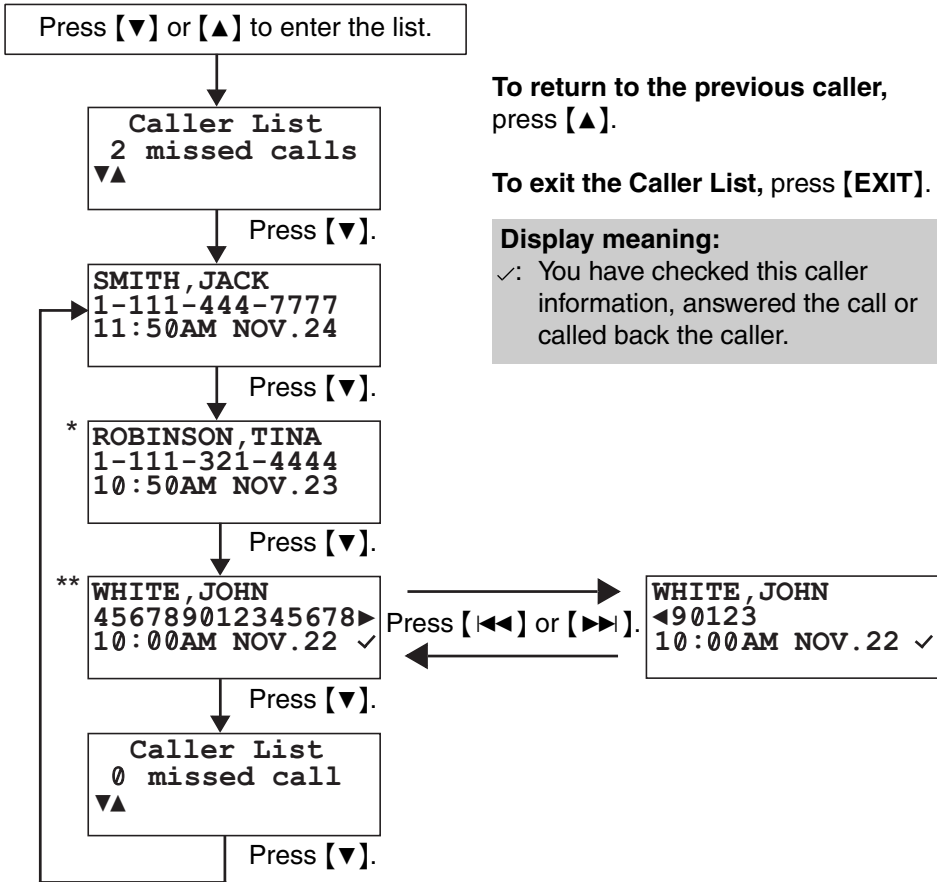

- * If you receive a call from one of the same phone numbers stored in the Phonebook or Direct Dial memory, the caller's name and number will be displayed (**Private name display**).
- ** If an arrow (▶) or (◀) is displayed after the number, the whole phone number has not been shown. Press [◀◀] or [▶▶] to see the remaining numbers or to return to the previous display. Each time you press [◀◀] or [▶▶], the display will change alternately.

Calling Back from the Caller List

- 1 Press [▼] or [▲] to enter the Caller List.
- 2 Scroll to the desired caller by pressing [▼] or [▲].
 - To exit the Caller List, press [EXIT] or wait for 60 seconds.
- 3 Lift the handset or press **[SP-PHONE/HEADSET]**.

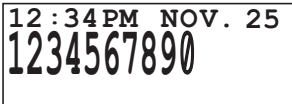

- The displayed phone number is dialed automatically.
- After a few seconds, the display will show the length of the call.
- In some cases, you may have to edit the number before dialing (see below).
- If a phone number is not displayed in the caller information, you cannot call back that caller.

Editing the Caller's Phone Number

You can edit a phone number in the Caller List by removing its area code and/or the long distance code "1". Once you call back and edited number, this unit can automatically edit incoming phone numbers from the same area code in the Caller List and each time you receive a call (**Caller ID Number Auto Edit**, page 14).

- 1 Press [▼] or [▲] to enter the Caller List.
- 2 Scroll to the desired caller by pressing [▼] or [▲].
- 3 Press [FUNCTION/EDIT].

- 4 Press [FUNCTION/EDIT], repeatedly until the number is shown in the desired format.
 - Each time you press [FUNCTION/EDIT], the number is rearranged into one of 3 patterns.

- (a) **Phone no.**
 - (b) **Area code** — **Phone no.**
 - (c) **1**—**Area code** — **Phone no.**
- The order of which pattern (a) — (c) are displayed depends on how the telephone number is displayed in step 2.

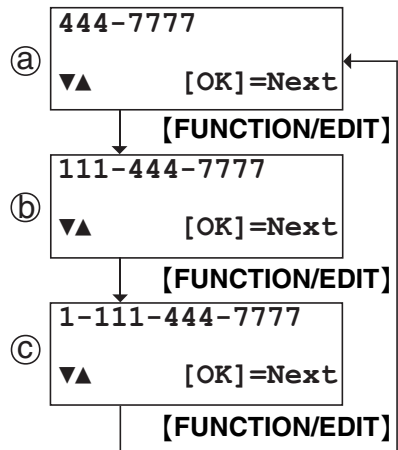

- 5 After editing, you can continue with calling back or storing procedures.
 - To call back, lift the handset or press [SP-PHONE/HEADSET].
 - To store the number in the Phonebook memory, follow steps 4 to 5 on page 28 to complete the operation.

To store the number in the Direct Dial memory, follow steps 4 to 6 on page 29 to complete the operation.

- To exit the Caller List during editing, press [EXIT] or wait for 60 seconds.
- The number edited in step 3 will not be maintained in the Caller List.

Storing Caller List Information in the Phonebook

You can store numbers that are in the Caller List in the Phonebook.

Make sure that the handset is on the cradle, the AC adaptor is connected and the SP-PHONE/HEADSET indicator light is off.

- 1** Press [▼] or [▲] to enter the Caller List.
- 2** Scroll to the caller you want to store in the Phonebook by pressing [▼] or [▲].
- 3** Press [FUNCTION/EDIT].
 - If the number requires editing, see page 27.

444-7777

▼▲ [OK]=Next

- 4** Press [OK] (Next key).

If there is name information for the caller, “Enter name” and caller’s name will be displayed. You can edit name information.

Enter name
SMITH, JACK
▲ [OK]=Next

- a) If you need to change the name, enter the name (p. 32). When finished, press [OK] (Next key).
- b) If you do not need to change the name press [OK] (Next key).

If there is no name information for the caller “Enter name” will be displayed.

- a) If a name is required, enter the name (p. 32). When finished, press [OK] (Next key).
- b) If a name is not required, press [OK] (Next key).

>Save phonebook
Save M1, M2, M3
▼ [OK]=Save

- 5** Press [OK] (Save key).

SMITH, JACK
444-7777

- A long beep sounds.
- The display will return to Caller List. You can continue storing other items. To exit the Caller List, press [EXIT] or wait for 60 seconds.
- If the display shows “Phonebook full” in step 5, press [EXIT] to exit the list. To erase other stored items from the Phonebook, see page 35.
- To cancel during programming, press [EXIT]. Start again from step 1.
- You cannot store caller information in the Phonebook if a phone number is not displayed.

To store an emergency number (#):

Emergency numbers are numbers stored in the Phonebook that can be dialed even when the Call Restriction (p. 42) is set to ON.

To store a number as an emergency number, add # at the beginning of the name in step 4.

Storing Caller List Information in the Direct Dial memory

You can store numbers in the Caller List to the Direct Dial memory ([M1], [M2] and [M3]).

Make sure that the handset is on the cradle, the AC adaptor is connected and the SP-PHONE/HEADSET indicator light is off.

- 1** Press [▼] or [▲] to enter the Caller List.
- 2** Scroll to the caller you want to store in the Direct Dial memory by pressing [▼] or [▲].
- 3** Press [FUNCTION/EDIT].
 - If the number requires editing, see page 27.

```
444-7777
▼▲      [OK]=Next
```

- 4** Press [OK] (Next key).

If there is name information for the caller, "Enter name" and caller's name will be displayed. You can edit name information.

```
Enter name
SMITH, JACK
▲      [OK]=Next
```

- a) If you need to change the name, enter the name (p. 32). When finished, press [OK] (Next key).
- b) If you do not need to change the name press [OK] (Next key).

If there is no name information for the caller "Enter name" will be displayed.

- a) If a name is required, enter the name (p. 32). When finished, press [OK] (Next key).
- b) If a name is not required, press [OK] (Next key).

```
>Save phonebook
Save M1, M2, M3
▼      [OK]=Save
```

- 5** Press [▼].

- 6** Press one of the Direct Dial button ([M1], [M2] or [M3]) (Save key). (Example: [M1] is pressed.)

If the Direct Dial button selected is occupied, the display will be shown as below.

```
M1 is occupied
Overwrite ?
[▲]=No [OK]=Yes
```

To overwrite, press [OK] (Yes key).

To select the other empty Direct Dial memory, press [▲] (No key) and press an empty Direct Dial button ([M1], [M2] or [M3]).

- A long beep sounds.
- The display will return to Caller List. You can continue storing other items. To exit the programming mode, press [EXIT] or wait for 60 seconds.
- To erase other stored items from the Direct Dial memory see page 37.
- To cancel during programming, press [EXIT]. Start again from step 1.
- You cannot store caller information in the Direct Dial memory if a phone number is not displayed.

Erasing Caller List Information

After checking the Caller List, you can erase some or all of the entries.

Make sure that the handset is on the cradle, the AC adaptor is connected and the SP-PHONE/HEADSET indicator light is off.

To erase a specific caller from the Caller List

- 1 Press [▼] or [▲] to enter the Caller List.
- 2 Scroll to the caller you want to erase from the Caller List by pressing [▼] or [▲].

SMITH, JACK
1-111-444-7777
10:50AM NOV.23 ✓

- 3 Press [ERASE].

Erased

- A long beep sounds and the information is erased.
- After a few seconds, the display will show the previous caller information.
- To exit the Caller List, press [EXIT] or wait for 60 seconds.

To erase all entries in the Caller List

Before erasing all entries, make sure that "0 missed call" is displayed at step 1.

- 1 Press [▼] or [▲] to enter the Caller List.
- 2 Press [ERASE].
- 3 Press [OK] (Yes key).

All erased

- A long beep sounds and all entries are erased.
- The unit will exit the Caller List.

Storing Names and Numbers in the Phonebook

You can store up to 50 names and phone numbers in the memory.

Make sure that the handset is on the cradle, the AC adaptor is connected and the SP-PHONE/HEADSET indicator light is off.

- 1** Press **[FUNCTION/EDIT]**.
- 2** Press **[OK]** (Yes key) at “save phonebook ?”.
 - The number of stored items is also displayed.
- 3** Enter a name, up to 15 characters using the dialing buttons (p. 32).
 - To move the cursor, press **[◀◀]** or **[▶▶]**.
 - If a name is not required, press **[OK]** (Next key) and go to step 5.
- 4** Press **[OK]** (Next key).
- 5** Enter a phone number up to 32 digits.
 - If you entered a wrong number, press **[ERASE]** and enter the correct number.
 - To erase all of the digits, press and hold **[ERASE]**.
 - If you want to change the storing name, press **[▲]** to reach the desired display.

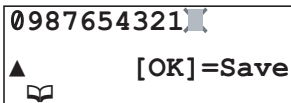

- 6** Press **[OK]** (save key).
 - A long beep sounds.
 - To continue storing other items, repeat from step 2.



- If the display shows “Phonebook full” in step 2, press **[EXIT]** to exit the list. To erase other stored items from the Phonebook, see page 35.
- You can exit the programming mode any time by pressing **[EXIT]**.
- If a pause is required for dialing, press **[PAUSE]** where needed. If required, you can also store **[FLASH]** in a phone number. Pressing **[PAUSE]** or **[FLASH]** counts as one digit (p. 38, 40).

To store an emergency number (#):

Emergency numbers are numbers stored in the Phonebook that can be dialed even when the Call Restriction (p. 42) is set to ON.

To store a number as an emergency number, add # at the beginning of the name in step 3.

Selecting characters to enter names

The dialing buttons ([0] to [9], [*] and [#]) can be used to enter letters and symbols. Pressing each button selects a character as shown below.

Key	Number of times key is pressed								
	1	2	3	4	5	6	7	8	9
[1]	&	'	()	,	-	.	/	1
[2]	a	b	c	A	B	C	2		
[3]	d	e	f	D	E	F	3		
[4]	g	h	i	G	H	I	4		
[5]	j	k	l	J	K	L	5		
[6]	m	n	o	M	N	O	6		
[7]	p	q	r	s	P	Q	R	S	7
[8]	t	u	v	T	U	V	8		
[9]	w	x	y	z	W	X	Y	Z	9
[*]	*								
[0]	0	Space							
[#]	#								
[◀◀]	To move the cursor to the left								
[▶▶]	To move the cursor to the right								

If you make a mistake while entering a name

Use [◀◀] or [▶▶] to move the cursor to the incorrect character, press [ERASE] to delete and enter the correct character. Each time you press [ERASE], a character is erased.

For example, to enter "Tom Jones":

- 1 Press [8] four times. T
- 2 Press [6] three times, then press [▶▶]. To
- 3 Press [6] once, then press [▶▶] twice. Tom
- 4 Press [5] four times, press [6] three times, then press [▶▶]. Tom Jo
- 5 Press [6] twice, press [3] twice, then press [7] four times. Tom Jones

Dialing from the Phonebook

Make sure that the handset is on the cradle, the AC adaptor is connected and the SP-PHONE/HEADSET indicator light is off.

1 Press [◀◀] or [▶▶] to enter the Phonebook.

2 Scroll to the desired item by pressing [▼] or [▲].

- All Phonebook items are stored in the order shown on the right figure.
- Item with # at the beginning will be displayed with first priority if Call Restriction is set to ON.

To search for a name by initial:

1. Press the dialing button for the first letter of the desired name until any name with the same initial is displayed (see the Index table on page 34).
Example: To find "Frank", press [3] repeatedly until the first item under "F" is displayed.
2. Press [▼] repeatedly until the name is displayed.

3 Lift the handset or press [SP-PHONE/HEADSET].

4 To hang up, place the handset on the cradle or press [SP-PHONE/HEADSET].

- If "No items stored" is displayed in step 1, the Phonebook is empty.
- You can exit the Phonebook list any time by pressing [EXIT].
- You can also dial the stored number as follows:
 1. Lift the handset or press [SP-PHONE/HEADSET].
 2. Find the desired item (above steps 1 and 2).
 3. Press [OK] (Send key).

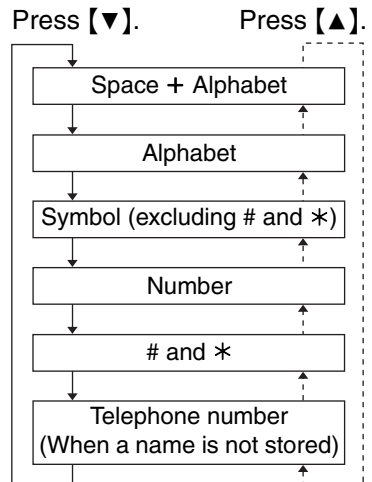

Index table

Keys	Index	Keys	Index
[1]	Symbols, 1	[7]	P, Q, R, S, 7
[2]	A, B, C, 2	[8]	T, U, V, 8
[3]	D, E, F, 3	[9]	W, X, Y, Z, 9
[4]	G, H, I, 4	[*]	*
[5]	J, K, L, 5	[0]	0, Space
[6]	M, N, O, 6	[#]	#

Chain Dial

You can dial a combination of Phonebook or manual key pad entries while making a call. This feature can be used, for example, to first automatically dial a calling card access number that you have stored in the Phonebook, then manually or automatically dial your PIN and then automatically dial the destination number from the Phonebook.

Example: Using a long distance calling card.

- To prevent misdialing, we recommend you add pauses where needed when storing numbers. For example, add pauses after a calling card access number and your PIN when storing in the Phonebook (p. 38).

1. Search and dial from Phonebook: 1800123456 (Calling card access number)
 - The Voice guidance may be announced.
2. Search and dial from Phonebook: 1234 (Calling card PIN)
3. Search and dial from Phonebook: 15550123456 (Destination number)

1 **While you are on a call;**
Press [**◀◀**] or [**▶▶**].

2 Search for the desired item by pressing [**▼**] or [**▲**].

- To search for an item by initial, see page 33.

3 Press [**OK**] (Send key).

- The phone number is dialed.
- If required, repeat steps 1 to 3 for any remaining number.
- When storing a calling card access number and your PIN in the Phonebook as one item, press [**PAUSE**] to add pauses after the number and PIN as necessary (p. 38).
- If you have rotary or pulse service, you need to press [*****] (**TONE**) before pressing [**◀◀**] or [**▶▶**] in step 1 to change the dialing mode temporarily to tone.

Editing

Make sure that the handset is on the cradle, the AC adaptor is connected and the SP-PHONE/HEADSET indicator light is off.

- 1** Press [**◀◀**] or [**▶▶**] to enter the Phonebook.
- 2** Scroll to the Phonebook item you want to change by pressing [**▼**] or [**▲**].
 - To search for the item by initial, see page 33.
- 3** Press [**FUNCTION/EDIT**].
 - If you do not need to change the name, go to step 5.
- 4** Edit the name using the dialing buttons [**0**] to [**9**], [*****] and [**#**] (p. 32).
 - To clear an incorrect character, move the cursor to the character by using [**◀◀**] or [**▶▶**], then press [**ERASE**].
- 5** Press [**OK**] (**N**ext key).
- 6** Insert the required numbers.
 - If you entered a wrong number, press [**ERASE**] and enter the correct number.
- 7** Press [**OK**] (**S**ave key).
 - A long beep sounds.
 - To exit the Phonebook, press [**EXIT**] or wait for 60 seconds.

Erasing

Make sure that the handset is on the cradle, the AC adaptor is connected and the SP-PHONE/HEADSET indicator light is off.

- 1** Press [**◀◀**] or [**▶▶**] to enter the Phonebook.
 - 2** Scroll to the Phonebook item that you want to erase by pressing [**▼**] or [**▲**].
 - To search for the item by initial, see page 33.
 - 3** Press [**ERASE**].
 - To stop erasing, press [**▲**] (**N**o key).
 - 4** Press [**OK**] (**Y**es key).
 - A long beep sounds and the item is erased.
 - To erase other items, repeat from step 2.
 - To exit the Phonebook list, press [**EXIT**].
- Item with # at beginning cannot be deleted when the Call Restriction (p. 42) is set to ON.
 - You can exit the programming mode any time by pressing [**EXIT**].

Storing Names and Numbers in the Direct Dial memory

You can store up to 3 names and phone numbers in the memory.

Make sure that the handset is on the cradle, the AC adaptor is connected and the SP-PHONE/HEADSET indicator light is off.

- 1** Press **[FUNCTION/EDIT]**.
- 2** Scroll to "Save M1, M2, M3 ?" by pressing **[▼]** or **[▲]** and press **[OK]** (Yes key).
- 3** Enter a name, up to 15 characters with the dialing buttons **[0]** to **[9]**, **[*]** and **[#]** (p. 32).
 - To move the cursor, press **[◀◀]** or **[▶▶]**.
 - If a name is not required, go to step 4.
- 4** Press **[OK]** (Next key).
- 5** Enter a phone number up to 32 digits.
 - If you enter a wrong number, press **[ERASE]** and enter the correct number.
 - To erase all of the digits, press and hold **[ERASE]**.
 - If you want to change the storing name, press **[▲]** to reach the desired display.

1234567890 **[X]**
[▲] M1, M2, M3=Save

- 6** Press one of the Direct Dial button (**[M1]**, **[M2]** or **[M3]**) (Save key).
(Example: **[M1]** is pressed.)
 - A long beep sounds.
 - The entered name and phone number are displayed.
 - After a few seconds, the display will return to step 2. To exit the programming mode, press **[EXIT]** or wait for 60 seconds.
 - When using the Call Restriction feature (p. 42), you cannot store a phone number in the Direct Dial memory (**[M1]**, **[M2]** or **[M3]**).

If the Direct Dial button selected manually is occupied, the display will be shown as below.

To overwrite, press **[OK]** (Yes key).

M1 is occupied
Overwrite ?
[▲]=No [OK]=Yes

To select the other empty Direct Dial memory, press **[▲]** (No key) and press an empty Direct Dial button (**[M1]**, **[M2]** or **[M3]**).

- A long beep sounds.
- The display will return to step 2. To exit the programming mode, press **[EXIT]** or wait for 60 seconds.
- To continue storing other items, repeat from step 2.

When using Call Restriction (p. 42), you may want to program emergency number in Direct Dial memory (**[M1]**, **[M2]** or **[M3]**).

To erase a stored number

- 1** Press the required Direct Dial button ([M1], [M2] or [M3]).
 - 2** Press [ERASE].
 - To stop erasing, press [▲] (No key).
 - 3** Press [OK] (Yes key).
 - A long beep sounds, the information is erased, then "Memory Empty" is displayed.
- To exit the programming mode, press [EXIT] or wait for 60 seconds.
 - When using the Call Restriction feature (p. 42), you cannot erase a phone number in the Direct Dial memory ([M1], [M2] or [M3]).
 - If a pause is required for dialing, press [PAUSE] where needed. If required, you can also store [FLASH] in a phone number. Pressing [PAUSE] or [FLASH] counts as one digit (p. 38, 40).

Dialing a Stored Number from the Direct Dial memory

- 1** Lift the handset or press [SP-PHONE/HEADSET].
 - 2** Press the required Direct Dial button ([M1], [M2] or [M3]).
 - The stored number is displayed and dialed.
- OR**
- 1** Press the required Direct Dial button ([M1], [M2] or [M3]).
 - The stored number is displayed.
 - 2** Lift the handset or press [SP-PHONE/HEADSET].
 - When you press the Direct Dial buttons continuously, confirm that the first dialing out have complete, then press the next button.
 - You can dial numbers stored in the Direct Dial memory ([M1], [M2] or [M3]) even if the Call Restriction feature (p. 42) is set.

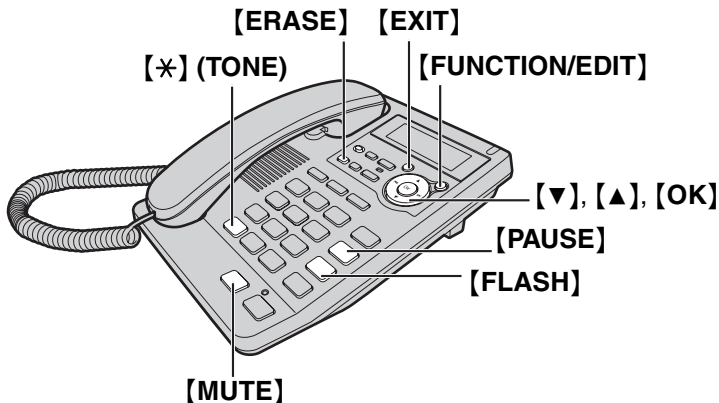

Temporary Tone Dialing (For Rotary or Pulse Service Users)

Press [*] (TONE) before entering access numbers which require tone dialing.

- The dialing mode changes to tone. You can enter numbers to access an answering service, electronic banking service, etc. When you hang up, the mode will return to pulse.

How to Use the PAUSE Button (For PBX Line/Long Distance Calls)

We recommend you press [PAUSE] if a pause is required for dialing with a PBX or to make a long distance call.

Example: Line access number [9] (PBX)

[9] → [PAUSE] →

- Pressing [PAUSE] once creates a 3.5 second pause. This prevents misdialing when you redial or dial a stored number.
- Pressing [PAUSE] more than once increases the length of the pause between numbers.

Muting Your Conversation

Press [MUTE] while talking. “” is displayed.

- The other party cannot hear you but you can hear them.
- To resume the conversation, press [MUTE] again.

For Call Waiting Service Users

Press **[FLASH]** if you hear a call-waiting tone while talking.

- The first call is put on hold and you can answer the second call.
- To return to the first caller, press **[FLASH]** again.
- The call waiting service cannot be used when a parallel connected telephone is in use.
- If this function does not operate properly, consult your telephone company for details.

Visual Call Waiting Caller ID Feature

Visual Call Waiting Caller ID Feature allows your unit to display the second caller's information. After you hear a call-waiting tone while talking, the unit will display the caller's phone number and "CALL WAIT".



- If the phone number is stored in the Phonebook or Direct Dial memory, the caller's name will be displayed.
- The second caller's information will not be displayed when a parallel connected telephone is in use.
- Please contact your service company for details and availability in your area.

Setting Hold Music to ON/OFF

You can set music play during the hold as follows. Your phone default setting is ON.

Make sure that the handset is on the cradle, the AC adaptor is connected and the SP-PHONE/HEADSET indicator light is off.

- 1 Press **[FUNCTION/EDIT]**.
- 2 Scroll to "Program ?" by pressing **[▼]** or **[▲]** and press **[OK]** (Yes key).
- 3 Scroll to "Set hold music ?" by pressing **[▼]** or **[▲]** and press **[OK]** (Yes key).
 - "♪" is displayed.

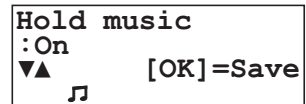

- 4 Select "On" or "Off" by pressing **[▼]** or **[▲]**.
- 5 Press **[OK]** (Save key).
 - A long beep sounds.
 - The display will return to step 3. To exit the programming mode, press **[EXIT]** or wait for 60 seconds.

FLASH Button

Pressing **[FLASH]** allows you to use special features of your host PBX such as transferring an extension call or accessing special telephone services (optional) such as call waiting.

Selecting the flash time

The flash time depends on your telephone exchange or host PBX. You can select the following flash times: “80, 90, 100, 110, 160, 200, 250, 300, 400, 600, 700, 900 ms (milliseconds)”. Your phone default setting is “600 ms”.

Make sure that the handset is on the cradle, the AC adaptor is connected and the SP-PHONE/HEADSET indicator light is off.

- 1** Press **[FUNCTION/EDIT]**.
- 2** Scroll to “**Program ?**” by pressing **[▼]** or **[▲]** and press **[OK]** (**Yes** key).
- 3** Scroll to “**Set flash time ?**” by pressing **[▼]** or **[▲]** and press **[OK]** (**Yes** key).

Flash time
: 600ms
▼▲ [OK]=Save

- 4** Select the desired time by pressing **[▼]** or **[▲]**.
 - 5** Press **[OK]** (**Save** key).
 - A long beep sounds.
 - The display will return to step 3. To exit the programming mode, press **[EXIT]** or wait for 60 seconds.
- You can exit the programming mode any time by pressing **[EXIT]**.
 - If the unit is connected via a PBX, PBX functions (transferring a call, etc.) might not work correctly. Consult your PBX supplier for the correct setting.
 - If the unit is not connected to AC adaptor, flash will not function.

Setting the Password

You can change the password for the call restriction. The default password is "1111".

To set the password

Make sure that the handset is on the cradle, the AC adaptor is connected and the SP-PHONE/HEADSET indicator light is off.

- 1 Press **[FUNCTION/EDIT]**.
- 2 Scroll to "Program ?" by pressing **[▼]** or **[▲]** and press **[OK]** (Yes key).
- 3 Scroll to "Change password?" by pressing **[▼]** or **[▲]** and press **[OK]** (Yes key).
- 4 Enter the current password.

Current password
 :****
[OK]=Next
- 5 Press **[OK]** (Next key).
 - If the wrong password was entered, 3 beeps will sound. Enter the correct password.

New password
 :----
[OK]=Save

- 6 Enter a new password using a 4-digit number.
(Example: "1234" is entered.)

New password
 : 1234
[OK]=Save

- 7 Press **[OK]** (Save key).
 - A long beep sounds.
 - The display will return to step 3. To exit the programming mode, press **[EXIT]** or wait for 60 seconds.
- You can exit the programming mode any time by pressing **[EXIT]**.

Please write down your password. If you forget your password, enter "Panasonic (726276642)" in step 4.

Call Restriction

You can prevent the unit from dialing phone numbers beginning with specified digit(s) (1 digit or 2 digits). Phone numbers with the restricted leading digits cannot be dialed out, except the emergency numbers stored in the Direct Dial memory (**[M1]**, **[M2]** or **[M3]**) or in Phonebook (To store a number as an emergency number in phonebook, add # at the beginning of the **name**).

Before using the Call Restriction feature, we recommend storing emergency numbers in the memory of Direct Dial Buttons (p. 36) and Phonebook (p. 31) as emergency numbers (#).

To set the call restriction

Make sure that the handset is on the cradle, the AC adaptor is connected and the SP-PHONE/HEADSET indicator light is off.

- 1 Press **[FUNCTION/EDIT]**.
- 2 Scroll to "Program ?" by pressing **[▼]** or **[▲]** and press **[OK]** (Yes key).
- 3 Scroll to "Call restrict ?" by pressing **[▼]** or **[▲]**.

```
Call restrict ?
▼▲           [OK]=Yes
```

- 4 Press **[OK]** (Yes key).

```
Restrict No.
:--           [OK]=Save
```

If you changed the password "1111" (default), the below display will be shown. Follow the following steps 1 and 2.

1. Enter the password (p. 41).

```
Enter password
:----
                [OK]=Next
```

2. Press **[OK]** (Next key). Go to step 5.
 - If the wrong password was entered, 3 beeps will sound. Enter the correct password.

```
Enter password
:****
                [OK]=Next
```

- 5 Enter the number(s) (1 digit or 2 digits) you want to restrict (**[0]** to **[9]**).
 - If the wrong number was entered, press **[ERASE]** and enter the correct number.

Example: "9" is entered.

```
Restrict No.
:9-
                [OK]=Save
```

- 6 Press **[OK]** (save key).
 - A long beep sounds.
 - The display will return to step 3. To exit the programming mode, press **[EXIT]** or wait for 60 seconds.

When dialing a phone number with the restricted leading digit(s), "CALL RESTRICTED" is displayed.

To cancel the call restriction

Follow steps 1 through 4. In step 5, press **[ERASE]** to clear the restricted digits, and press **[OK]** (save key).

Automatic Answering Operation

When the unit answers a call, a greeting message is played and the caller's message is recorded. When recording, “-Answering-” will flash on the display.

- The recording time is about 15 minutes.
If messages are recorded in noisy rooms, the time may be shortened by up to 3 minutes.
- A maximum of 64 messages can be recorded.

Setting the Unit to Answer Calls

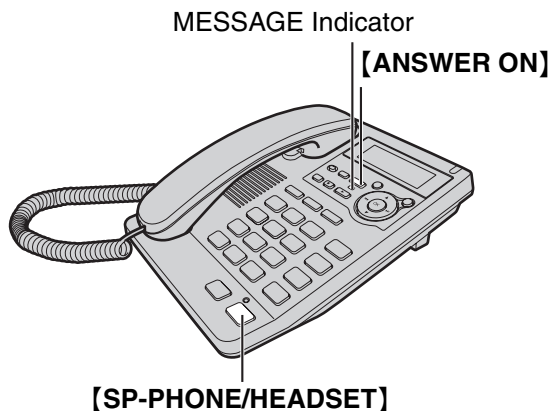

Press **[ANSWER ON]** to turn on the answering system.

- The MESSAGE indicator lights and the unit announces “Answer set” and the current day and time.
- The unit will announce the remaining recording time if it is less than 3 minutes.
- If you hear “Memory full” and “**Message full**” is displayed, erase some, or all, of the messages (p. 46).
- If you do not want the unit to answer calls, press **[ANSWER ON]** again to turn off the answering system. The indicator light goes out and “Answer off” is heard.
- You can also turn on the answering system remotely using any other phone (p. 51).

Monitoring incoming calls

While a call is being recorded, you can monitor it through the speaker.

- To increase the speaker volume, press **VOLUME [▲]**. To decrease, press **VOLUME [▼]**.

To answer the call, lift the handset or press **[SP-PHONE/HEADSET]**. The unit stops recording.

Listening to Messages

You can see the total number of recorded messages on the display. If the MESSAGE indicator flashes (only when the Answering System is ON), new messages have been recorded.

To play back messages, press **[MESSAGE/2WAY REC]**.

When you have new messages:

The unit announces the number of new messages and only new messages are played back.

When you have no new message:

The unit announces “No new message. All message playback” and plays back all messages.

When you have no message:

The unit announces “No message”.

- At the end of the last message, “End of final message” is heard. The unit will announce the remaining recording time if it is less than 3 minutes.

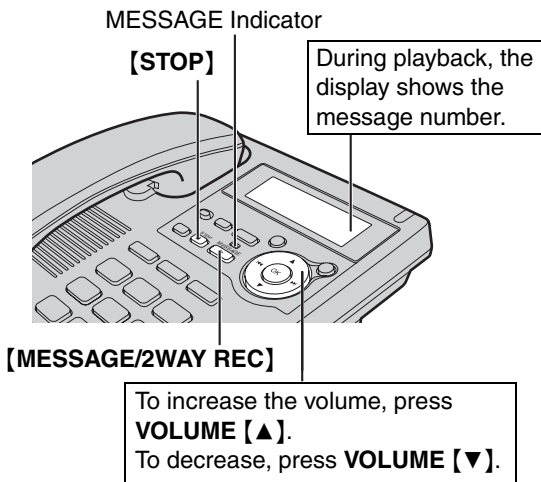

During playback

To repeat message	To repeat from the beginning of the message Press [⏮]. • If you press within 5 seconds of playback, the previous message will be played.
To skip message	To skip to the next message Press [⏭].
To stop operation	Press [STOP]. • To resume playback, press [MESSAGE/2WAY REC]. • If you do not press any button for 60 seconds or if you press [STOP] again, the playback mode will be canceled.

For Caller ID service users (p. 24)

During playback, the display will show the name and/or number of the caller whose message is being played.

JONES , JENNIFER 1-222-333-4444 - Message 3 -

To call back the displayed number:

During playback, lift the handset or press [**SP-PHONE/HEADSET**].

- The unit stops playback and automatically dials the displayed phone number.

Recording Your Telephone Conversation

You can record your conversation while talking using the handset or [**SP-PHONE/HEADSET**].

- 1 During a conversation, press [**MESSAGE/2WAY REC**].
 - "Recording" is displayed.
- 2 Continue your conversation.
- 3 To stop recording the conversation, press [**MESSAGE/2WAY REC**] or [**STOP**].
 - The MESSAGE indicator flashes (only when the Answering System is ON).

- When you record your 2-way telephone conversation, you should inform the other party that the conversation is being recorded.

Erasing Messages

The unit will announce the remaining recording time after playback, if it is less than 3 minutes. New messages cannot be recorded when:

- “Memory full” is heard.
- “**Message full**” is displayed.
- The MESSAGE indicator flashes rapidly (only when the Answering System is on).

Erase some, or all, of the messages. We recommend you erase unnecessary messages after each playback.

Erasing a specific message

Press **[ERASE]** while the message you want to erase is being played.

- The unit erases the message.
- A short beep will sound and the unit will continue to play the next message.

Erasing all messages

All recorded messages, except the greeting message, can be erased at one time.

- 1** Press **[ERASE]**.
 - “To erase all messages press ERASE again” is heard.
- 2** Within 10 seconds, press **[ERASE]** again.
 - A long beep sounds and “No message” is heard. The display shows “**0 message**”.

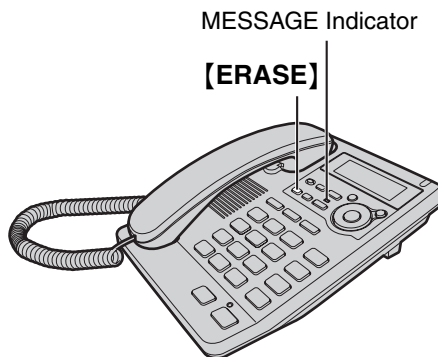

- The information in the Caller List will not be erased. To erase Caller List information, see page 30.

Remote Operation from a Touch Tone Phone

You can operate the answering system from any touch tone phone. A synthesized voice menu will guide you on how to operate the unit (p. 49).

- To skip the voice menu and operate the unit directly, see page 50.

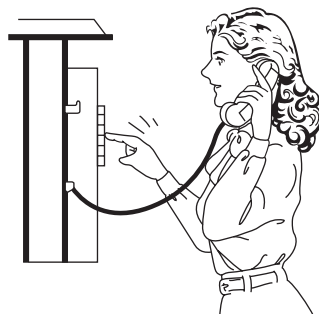

Summary of remote operation

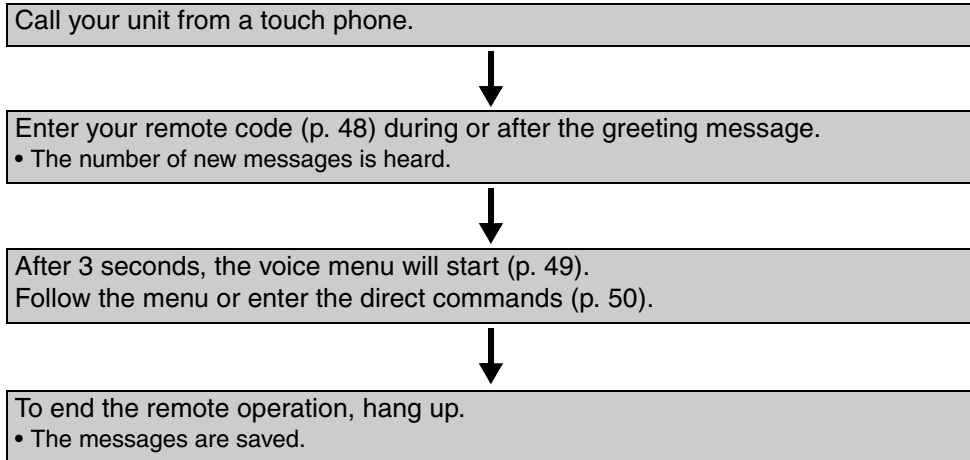

- The unit will announce the remaining recording time after playback, if it is less than 3 minutes.

Remote Code

The remote code prevents unauthorized people from accessing your unit and listening to your messages. Choose any 2-digit number (00–99).

Your phone default remote code is “11”. If you do not program your own remote code, you can use “11”.

Make sure that the handset is on the cradle, the AC adaptor is connected and the SP-PHONE/HEADSET indicator light is off.

- 1** Press **[FUNCTION/EDIT]**.
- 2** Scroll to “**Set answering ?**” by pressing **[▼]** or **[▲]** and press **[OK]** (Yes key).
- 3** Scroll to “**Remote code ?**” by pressing **[▼]** or **[▲]** and press **[OK]** (Yes key).
- 4** Enter a new code using a 2-digit number.
(Example: “23” is entered.)
- 5** Press **[OK]** (Save key).
 - A long beep sounds.
 - The display will return to step 3. To exit the programming mode, press **[EXIT]** or wait for 60 seconds.

Remote code :23 [OK]=Save

- You can exit the programming mode any time by pressing **[EXIT]**.

To check the remote code

Repeat steps 1 to 3.

- The current remote code is displayed. When finished, press **[EXIT]**.

Voice Menu

The shaded boxes are voice prompts.

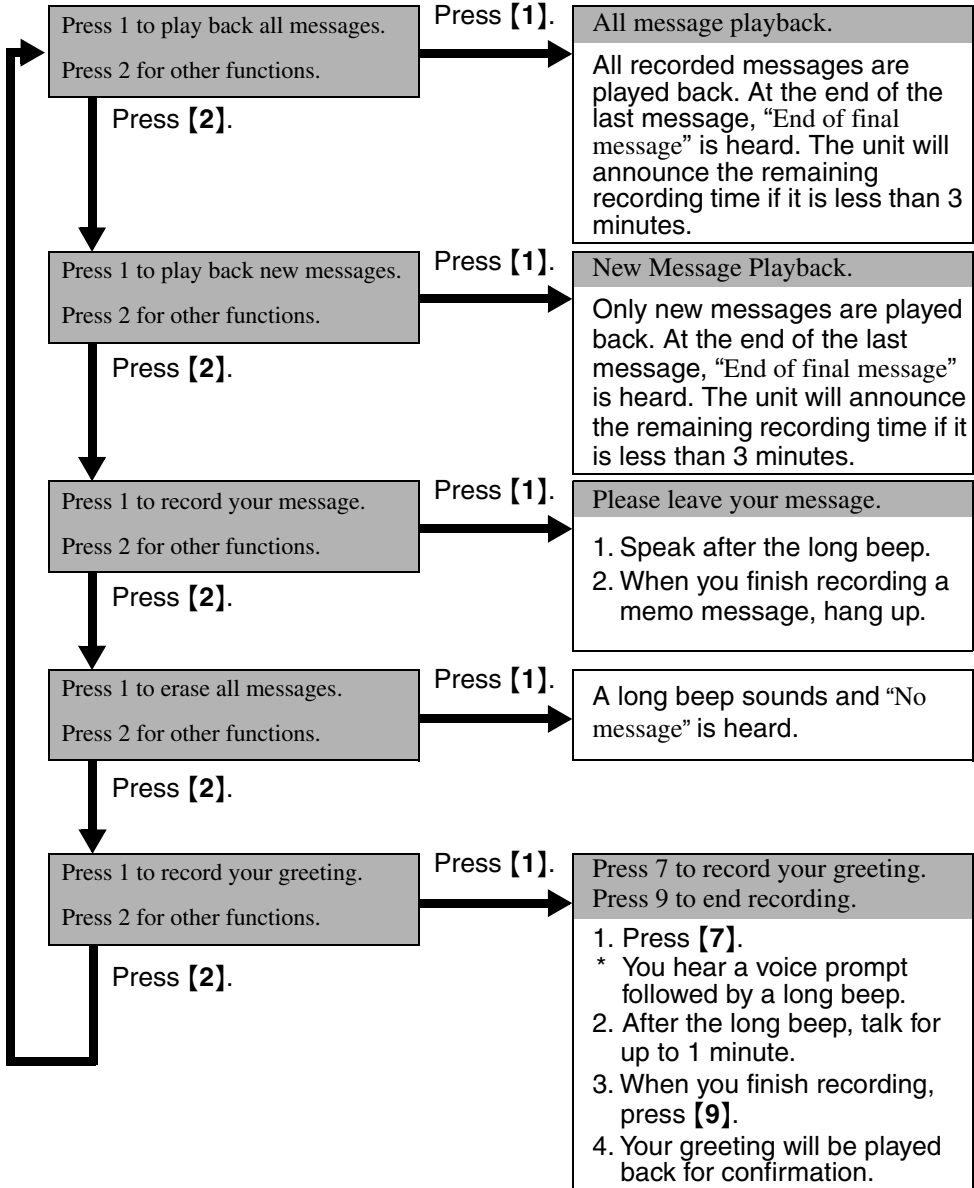

- 3 seconds after playback, the voice menu will start again from the beginning.
- If you hear “Memory full” after playback, erase some, or all, of the messages (p. 46).

Direct Remote Operation

Once you have entered the remote code, you can also control your unit by direct commands instead of using the voice menu. To end the remote operation, hang up anytime.

Direct commands

NEW MESSAGE PLAYBACK	[4]	<ul style="list-style-type: none">• Only new messages are played back.
ALL MESSAGES PLAYBACK	[5]	<ul style="list-style-type: none">• All messages are played back.
REPEAT (During playback)	[1]	<ul style="list-style-type: none">• The current message is repeated.
SKIP (During playback)	[2]	<ul style="list-style-type: none">• The current message is skipped. The next message is played.
STOP (During playback)	[9]	<ul style="list-style-type: none">• Operation is stopped temporarily.• To resume operation, enter a direct command within 15 seconds, or the voice menu will start (p. 49).
GREETING MESSAGE RECORDING	[7] ↓ RECORD ↓ [9]	<ul style="list-style-type: none">• A long beep sounds.• After the beep, talk immediately for up to 1 minute.• The recording is stopped.• The recorded message is played.
ERASING A SPECIFIC MESSAGE (During playback)	[*] [4]	<ul style="list-style-type: none">• The current message is erased.• A short beep will sound and the next message will be played.
ERASING ALL MESSAGES	[*] [5]	<ul style="list-style-type: none">• All recorded messages are erased.• A long beep sounds and “No message” is heard.
ANSWERING SYSTEM OFF	[0]	<ul style="list-style-type: none">• When you press [0], “Answer off. Thank you for your call” is heard, the unit hangs up and will not answer calls until turned on again.

Turning on the answering system

Call your unit and wait for 15 rings.

- The unit will answer and the greeting message will be played.
- The answering system will turn on. Hang up or enter the remote code for other options.
- When turning on the answering system using a rotary or pulse service telephone, you cannot enter the remote code for other options.

Skipping the greeting message

After calling your unit, press **[*] (TONE)** during the greeting message.

- The unit skips the rest of the greeting message and you can start recording your message after the long beep.

Wall Mounting

This unit can be mounted on a wall.

- 1 Press the tabs in the direction of the arrows (①), then remove the wall mounting adaptor (②).

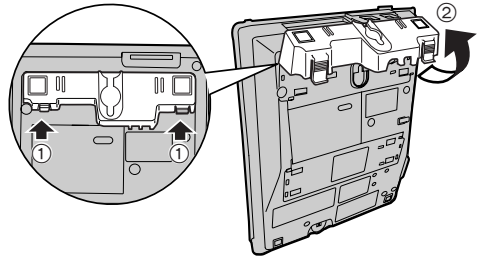

- 2 Connect the AC adaptor. Tuck the telephone line cord inside the wall mounting adaptor, and push it in the direction of the arrow.
 - "UP WALL" should be facing upward.

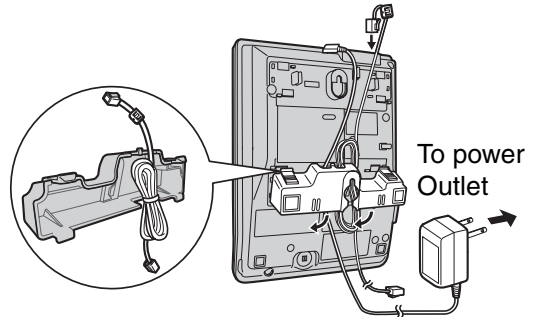

- 3 Drive screws (not included) into the wall using the wall template below. Connect the telephone line cord. Mount the unit, and slide it down.

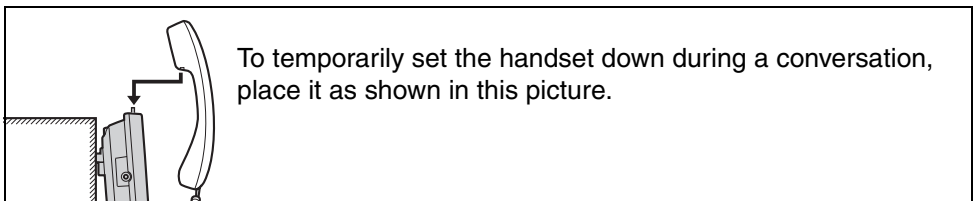
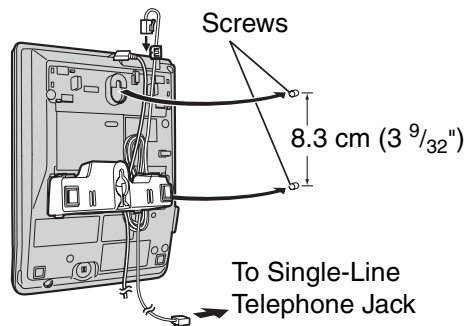

Wall Template

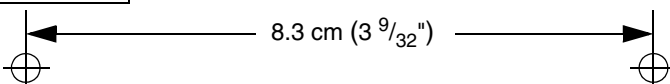

Optional Headset

Plugging the optional headset into the unit allows a hands-free phone conversation. Please use only a Panasonic KX-TCA60, KX-TCA86, KX-TCA88HA, KX-TCA91, KX-TCA92, KX-TCA93, KX-TCA94, KX-TCA95 or KX-TCA98. To order, call the accessories telephone number on page 3.

Connecting the optional headset to the unit

Connect the optional headset to the headset jack as shown below.

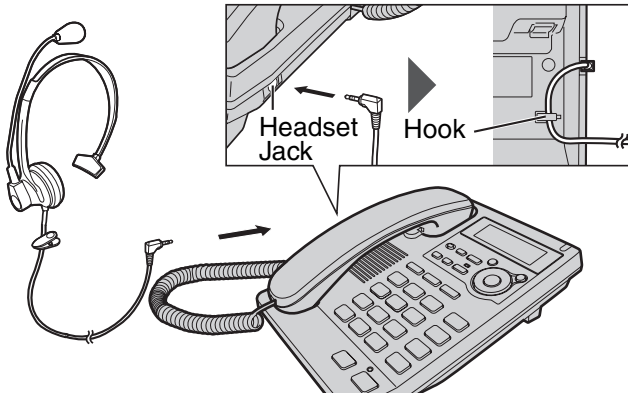

If you want to have a conversation without hands-free feature, disconnect the headset.

Making/Answering calls

- 1** Press **[SP-PHONE/HEADSET]** to make or answer a call.
 - The SP-PHONE/HEADSET indicator lights.
 - If you misdial when making a call, press **[SP-PHONE/HEADSET]** twice and dial again.
- 2** To hang up, press **[SP-PHONE/HEADSET]**.
 - The indicator light goes out.

To adjust the headset receiver volume (4 levels):

While using the headset, press **VOLUME [▲]** or **[▼]**.

- "■" shows one level.
- During a conversation using the headset, you cannot switch the call to using the handset by simply lifting it off the cradle.
- If you disconnect the optional headset during a conversation with the handset on the cradle, the call will be switched to the speakerphone.
- During a conversation using the speakerphone, you can switch the call to the headset by connecting the headset.

Troubleshooting

Problem	Cause and Remedy
The unit does not work.	<ul style="list-style-type: none"> • Check the settings (p. 9–15). • Unplug the AC adaptor to reset. Plug in, and try again.
The unit does not ring.	<ul style="list-style-type: none"> • The ringer volume is set to OFF and “\mathcal{A}” is displayed. Select the ringer volume to HIGH, MID or LOW by pressing [HOLD/RINGER] (p. 14).
You cannot dial.	<ul style="list-style-type: none"> • Check that the dialing mode selection is correct (p. 13). • The dialed number is restricted. To cancel, see page 42.
The other party suddenly cannot hear your voice during a conversation.	<ul style="list-style-type: none"> • [MUTE] may have been pressed during the conversation. If “\mathcal{X}” is displayed, press [MUTE].
You cannot program items such as the dialing mode.	<ul style="list-style-type: none"> • Programming is not possible when the handset is off the cradle, the SP-PHONE/HEADSET indicator lights, or when viewing caller information. • Do not pause for over 60 seconds while programming.
You cannot store a name and phone number in memory.	<ul style="list-style-type: none"> • Programming is not possible when the handset is off the cradle or the SP-PHONE/HEADSET indicator lights. • Check the AC adaptor is connected to the unit. • Do not pause for over 60 seconds while storing. • Do not enter a phone number more than 32 digits long. • When using the Call Restriction feature (p. 42), you cannot store a phone number in the Direct Dial memory ([M1], [M2] or [M3]) and emergency numbers (#). • If “Phonebook full” is displayed, erase other stored items from the Phonebook memory (p. 35).
While programming or searching, the unit starts to ring and stops the program/search.	<ul style="list-style-type: none"> • To answer the call, lift the handset or press [SP-PHONE/HEADSET]. Start again from the beginning after hanging up.

Problem	Cause and Remedy
The unit does not display the caller's name and phone number.	<ul style="list-style-type: none"> • You need to subscribe to a Caller ID service. • Check the AC adaptor is connected to the unit. • If you receive a call with the Caller ID information while viewing the Caller List, the redial list, the Phonebook list or the Direct Dial Memory, while programming or while playing back the message, the caller's information may not be displayed. • Other telephone equipment may be interfering with your phone. Disconnect it and try again. • Other electrical appliances connected to the same outlet may be interfering with the Caller ID information. • Telephone line noise may be interfering with the Caller ID information. Consult your telephone company. • If your unit is connected to a telephone line with DSL service, we recommend connecting a noise filter between the base unit and the telephone line jack. Contact your DSL provider for details.
The display exits the Caller List.	<ul style="list-style-type: none"> • Do not pause for over 60 seconds while searching.
You cannot redial by pressing [REDIAL] .	<ul style="list-style-type: none"> • If the last number dialed was more than 32 digits long, the number will not be redialed correctly.

Answering System

Problem	Cause and Remedy
The answering system is on, but incoming messages are not recorded.	<ul style="list-style-type: none"> • The recording time is set to "Greeting only". Select "1 minute", "2 minutes" or "3 minutes" (p. 20). • Memory is full. Erase some, or all, of the messages (p. 46).
The MESSAGE indicator flashes rapidly, "Message full" is displayed, and no new messages are recorded.	<ul style="list-style-type: none"> • Memory is full. Erase some, or all, of the messages (p. 46).
You cannot operate the answering system from a touch tone phone.	<ul style="list-style-type: none"> • Make sure you enter the correct remote code. • The answering system may not respond if the tones are too short to activate the unit. Press each button firmly. • The answering system is off. Turn it on (p. 51).
You cannot operate the answering system.	<ul style="list-style-type: none"> • Someone is operating the answering system. • The unit is recording a message. To answer the call, lift the handset or press [SP-PHONE/HEADSET].
Caller ID information is not displayed during message playback (p. 45).	<ul style="list-style-type: none"> • The caller information will not be displayed if the Caller List is renewed and the caller information is erased (p. 24).

Specifications

Power Supply:	AC adaptor (AC 120 V, 60 Hz)
Power Consumption:	Standby: Approx. 2.4 W Maximum: Approx. 3.0 W
Dimensions (H x W x D):	Approx. 91 mm x 165 mm x 220 mm (3 ¹⁹ / ₃₂ " x 6 ¹ / ₂ " x 8 ²¹ / ₃₂ ")
Mass (Weight):	Approx. 670 g (1.49 lb.)
Dialing Mode:	Tone (DTMF)/Pulse
Operating Environment:	5°C – 40°C (41°F – 104°F)

- Specifications are subject to change without notice.
- The illustrations used in these operating instructions may differ slightly from the actual product.

FCC and Other Information

This equipment complies with Part 68 of the FCC rules and the requirements adopted by the ACTA. On the bottom of this equipment is a label that contains, among other information, a product identifier in the format US:ACJ-----.

If requested, this number must be provided to the telephone company.

Registration No..... (found on the bottom of the unit)
Ringer Equivalence No. (REN)..... 1.0B

A plug and jack used to connect this equipment to the premises wiring and telephone network must comply with the applicable FCC Part 68 rules and requirements adopted by the ACTA. A compliant telephone cord and modular plug is provided with this product. It is designed to be connected to a compatible modular jack that is also compliant.

The REN is used to determine the number of devices that may be connected to a telephone line. Excessive RENs on a telephone line may result in the devices not ringing in response to an incoming call. In most but not all areas, the sum of RENs should not exceed five (5.0). To be certain of the number of devices that may be connected to a line, as determined by the total RENs, contact the local telephone company. For products approved after July 23, 2001, the REN for this product is part of the product identifier that has the format US:AAAEQ##TXXXX. The digits represented by ## are the REN without a decimal point (e.g., 03 is a REN of 0.3).

If this equipment causes harm to the telephone network, the telephone company will notify you in advance that temporary discontinuance of service may be required. But if advance notice isn't practical, the telephone company will notify the customer as soon as possible. Also, you will be advised of your right to file a complaint with the FCC if you believe it is necessary.

The telephone company may make changes in its facilities, equipment, operations or procedures that could affect the operation of the equipment. If this happens the telephone company will provide advance notice in order for you to make necessary modifications to maintain uninterrupted service.

If trouble is experienced with this equipment, for repair or warranty information, please contact a Factory Servicenter or other Authorized Servicer. If the equipment is causing harm to the telephone network, the telephone company may request that you disconnect the equipment until the problem is resolved.

Connection to party line service is subject to state tariffs. Contact the state public utility commission, public service commission or corporation commission for information.

If your home has specially wired alarm equipment connected to the telephone line, ensure the installation of this equipment does not disable your alarm equipment. If you have questions about what will disable alarm equipment, consult your telephone company or a qualified installer.

This device complies with Part 15 of the FCC Rules. Operation is subject to the following two conditions: (1) This device may not cause harmful interference, and (2) this device must accept any interference received, including interference that may cause undesired operation.

CAUTION:

Any changes or modifications not expressly approved by the party responsible for compliance could void the user's authority to operate this device.

Note:

This equipment has been tested and found to comply with the limits for a Class B digital device, pursuant to Part 15 of the FCC Rules. These limits are designed to provide reasonable protection against harmful interference in a residential installation. This equipment generates, uses, and can radiate radio frequency energy and, if not installed and used in accordance with the instructions, may cause harmful interference to radio communications. However, there is no guarantee that interference will not occur in a particular installation. If this equipment does cause harmful interference to radio or television reception, which can be determined by turning the equipment off and on, the user is encouraged to try to correct the interference by one or more of the following measures:

- Reorient or relocate the receiving antenna.
- Increase the separation between the equipment and receiver.
- Connect the equipment into an outlet on a circuit different from that to which the receiver is connected.
- Consult the dealer or an experienced radio/TV technician for help.

This equipment is hearing aid compatible as defined by the FCC in 47 CFR Section 68.316.

- **Environment**—do not place the unit in room where the temperature is less than 5°C (41°F) or greater than 40°C (104°F). Allow 10 cm (4") clearance around the unit for proper ventilation. Avoid excessive smoke, dust, mechanical vibration, shock, or direct sunlight.
- **Routine care**—wipe the unit with a soft cloth. Do not use benzine, thinner, or any abrasive powder.
- **If there is any trouble**—disconnect the unit from the telephone line and connect a known working phone. If the known working phone operates properly, have your unit repaired by one of the authorized Panasonic Factory Service Centers. If the known working phone does not operate properly, consult your telephone company.

Index**A**

Accessories Information: 3
Answering Calls: 23
Answering System: 43

C

Call Restriction: 42
Call Waiting: 39
Caller ID Number Auto Edit: 14
Caller ID Service:
 Private Name Display: 24
Caller List
 Calling Back: 27
 Editing: 27
 Erasing: 30
 Storing: 28
 Viewing: 25
Call Screening: 20
Chain Dial: 34

D

Dialing Mode: 13
Direct Dial
 Dialing: 37
Display: 8
Display Language: 13

F

FCC and Other Information: 57
Flash Button: 40
Flash time: 40

G

Greeting Message: 16

H

Headset: 53
Hold/Ringer: 14

I

Important Safety Instructions: 4

L

LCD Contrast: 14
Listening to Messages: 44

M

Making Calls: 21
Mute: 38

N

Navigator key: 6
Number of Rings: 19

P

Password: 41
PAUSE: 38
Phonebook
 Chain Dial: 34
 Editing: 35
 Erasing: 35
 Storing: 31
 Pulse Service: 38

R

Redial: 22
Remote Code: 48
Remote Operation: 47
Ringer Volume: 14
Rotary Service, Tone Dialing: 38

S

Safety Instructions: 4
Specifications: 56

T

Time and Date: 12
Time Adjustment: 15
Troubleshooting: 54

W

Wall Mounting: 52
Warranty: 60

Warranty

**PANASONIC CONSUMER
ELECTRONICS COMPANY, DIVISION
OF PANASONIC CORPORATION OF
NORTH AMERICA**
One Panasonic Way,
Secaucus, New Jersey 07094

PANASONIC PUERTO RICO, INC.
San Gabriel Industrial Park,
Ave. 65 de Infantería, Km. 9.5,
Carolina, Puerto Rico 00985

Panasonic Telephone Limited Warranty

Limited Warranty Coverage

If your telephone (identified in your Operating Instructions) does not work properly because of a defect in materials or workmanship, Panasonic Consumer Electronics Company or Panasonic Puerto Rico, Inc. (collectively referred to as “the warrantor”) will, for the length of the period indicated on the chart below, which starts with the date of original purchase (“Limited Warranty period”), at its option either (a) repair your product with new or refurbished parts, or (b) replace it with a new or a refurbished product. The decision to repair or replace will be made by the warrantor.

Parts	Labor
One (1) Year	One (1) Year

During the “Labor” Limited Warranty period there will be no charge for labor. During the “Parts” Limited Warranty period, there will be no charge for parts. You must mail-in your product during the Limited Warranty period. This Limited Warranty excludes both parts and labor for batteries, antennas, and cosmetic parts (cabinet). This Limited Warranty only applies to products purchased and serviced in the United State or Puerto Rico. This Limited Warranty is extended only to the original purchaser and only covers products purchased as new. A purchase receipt or other proof of the original purchase date is required for warranty service.

To obtain service in the USA please contact:

Panasonic Services Company, Panasonic Plus Department
20421 84th Avenue South
Kent, WA 98032
Tel: 1-800-833-9626 Fax: 1-800-237-9080

For assistance in Puerto Rico call Panasonic Puerto Rico, Inc. (787)-750-4300 or fax (787)-768-2910.

For Limited Warranty service for headsets if a headset is included with this product please call Panasonic Plus Department at 1-800-833-9626.

When shipping the unit carefully pack, include all accessories, and send it prepaid, adequately insured and preferably in the original carton. Include a letter detailing the complaint, a return address and a day time phone number where you can be reached.

Limited Warranty Limits And Exclusions

This Limited Warranty **ONLY COVERS** failure due to defects in materials or workmanship, and **DOES NOT COVER** normal wear and tear or cosmetic damage. The Limited Warranty **ALSO DOES NOT COVER** damages which occurred in shipment, or failures which are caused by products not supplied by the warrantor, or failures which result from accidents, misuse, abuse, neglect, mishandling, misapplication, alteration, faulty installation, set-up adjustments, misadjustment of consumer controls, improper maintenance, power line surge, lightning damage, modification, introduction of sand, humidity or liquids, commercial use such as hotel, office, restaurant, or other business or rental use of the product, or service by anyone other than a Factory Servicenter or other Authorized Servicer, or damage that is attributable to acts of God.

THERE ARE NO EXPRESS WARRANTIES EXCEPT AS LISTED UNDER “LIMITED WARRANTY COVERAGE”. THE WARRANTOR IS NOT LIABLE FOR INCIDENTAL OR CONSEQUENTIAL DAMAGES RESULTING FROM THE USE OF THIS PRODUCT, OR ARISING OUT OF ANY BREACH OF THIS LIMITED WARRANTY. (As examples, this excludes damages for lost time, lost calls or messages, cost of having someone remove or re-install an installed unit if applicable, travel to and from the servicer. The items listed are not exclusive, but are for illustration only.) **ALL EXPRESS AND IMPLIED WARRANTIES, INCLUDING THE WARRANTY OF MERCHANTABILITY, ARE LIMITED TO THE PERIOD OF THE LIMITED WARRANTY.**

Some states do not allow the exclusion or limitation of incidental or consequential damages, or limitations on how long an implied warranty lasts, so the exclusions may not apply to you.

This Limited Warranty gives you specific legal rights and you may also have other rights which vary from state to state. If a problem with this product develops during or after the Limited Warranty period, you may contact your dealer or Servicenter. If the problem is not handled to your satisfaction, then write to the warrantor’s Consumer Affairs Department at the address listed for the warrantor.

PARTS AND SERVICE, WHICH ARE NOT COVERED BY THIS LIMITED WARRANTY, ARE YOUR RESPONSIBILITY.

Customer services

Customer Services Directory

Obtain Product Information and Operating Assistance; locate your nearest Dealer or Servicenter; purchase Parts and Accessories; or make Customer Service and Literature requests by visiting our Web site at:

<http://www.panasonic.com/consumersupport>

or, contact us via the web at:

<http://www.panasonic.com/contactinfo>

You may also contact us directly at 1-800-211-PANA (7262),
Monday-Friday 9 am-9 pm; Saturday-Sunday 10 am-7 pm, EST.

TTY users (hearing or speech impaired users) can call 1-877-833-8855.

Accessory Purchases

Purchase Parts, Accessories and Instruction Books online for all Panasonic Products by visiting our Web Site at:

<http://www.pasc.panasonic.com>

or, send your request by E-mail to:

npcpart@us.panasonic.com

You may also contact us directly at:
1-800-332-5368 (Phone) 1-800-237-9080 (Fax only)
(Monday-Friday 9 am to 8 pm, EST.)

Panasonic Services Company
20421 84th Avenue South, Kent, WA 98032
(We Accept Visa, MasterCard, Discover Card, American Express, and
Personal Checks)

TTY users (hearing or speech impaired users) can call 1-866-605-1277.

Service in Puerto Rico

Panasonic Puerto Rico, Inc.
San Gabriel Industrial Park, Ave. 65 de Infantería, Km. 9.5,
Carolina, Puerto Rico 00985
Phone (787)750-4300, Fax (787)768-2910

If you need assistance with setup or operation;

- 1 Visit our website: <http://www.panasonic.com/consumersupport>
- 2 Contact us via the web at: <http://www.panasonic.com/contactinfo>
- 3 Call us at: 1-800-211-PANA (7262)
TTY users (hearing or speech impaired users) can call 1-877-833-8855

When you ship the product

- Carefully pack your unit, preferably in the original carton.
- Attach a letter, detailing the symptom, to the outside of the carton.

Symptom

- Send the unit to an authorized servicer, prepaid and adequately insured.
- Do not send your unit to the Panasonic Consumer Electronics Company listed below or to executive or regional sales office. These locations do not repair consumer products.

**If you need to assistance with the setup or operation,
please call 1-800-211-PANA(7262)
For hearing or speech impaired TTY users, TTY : 1-877-833-8855**

Copyright:

This material is copyrighted by Panasonic Communications (Malaysia) Sdn. Bhd., and may be reproduced for internal use only. All other reproduction, in whole or in part, is prohibited without the written consent of Panasonic Communications (Malaysia) Sdn. Bhd.

© 2006 Panasonic Communications (Malaysia) Sdn. Bhd. All Rights Reserved.

**Panasonic Consumer Electronics Company,
Division of Panasonic Corporation of North America**
One Panasonic Way, Secaucus, New Jersey 07094

Panasonic Puerto Rico, Inc.

San Gabriel Industrial Park, Ave. 65 de Infantería, Km. 9.5,
Carolina, Puerto Rico 00985



T5620

PQQX15397YA FM0506SS1

For assistance, please visit <http://www.panasonic.com/phonehelp>