

# Panasonic<sup>®</sup>

## Operating Instructions for advanced features

Digital Camera

Model No. **DMC-FT4/DMC-TS4**

**LUMIX**

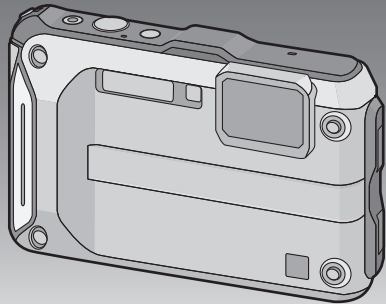

Before use, please read these instructions completely.



VQT4E30  
F0212MG0

# Contents

---

---

## Before Use

---

---

Care of the camera .....	5
(Important) About the Waterproof/ Dustproof and Anti-shock Performance of the Camera .....	8
Standard Accessories .....	13
Names of the Components .....	14

---

---

## Preparation

---

---

Attaching the Strap.....	16
Charging the Battery .....	17
• Charging .....	17
• Approximate operating time and number of recordable pictures .....	19
Inserting and Removing the Card (optional)/the Battery.....	21
About the Built-in Memory/the Card .....	23
• Approximate number of recordable pictures and available recording time .....	25
Setting Date/Time (Clock Set).....	27
• Changing the clock setting .....	28
Tips for taking good pictures .....	29
• Fit the strap and hold the camera carefully .....	29
• Preventing jitter (camera shake).....	29

---

---

## Basic

---

---

Selecting the Recording Mode .....	30
Taking Pictures with Your Favourite Settings (Programme AE Mode) .....	32
Focusing.....	33
Taking Pictures Using the Automatic Function (Intelligent Auto Mode) .....	35
• Changing the settings .....	37
Recording Motion Pictures .....	38

Playing Back Pictures ([Normal Play]).....	40
• Selecting a picture.....	40
• Displaying Multiple Screens (Multi Playback) .....	41
• Using the Playback Zoom .....	41
Playing Back Motion Pictures .....	42
• Creating Still Pictures from a Motion Picture .....	43
Deleting Pictures .....	44
• To delete a single picture .....	44
• To delete multiple pictures (up to 100) or all the pictures .....	45
Setting the Menu .....	46
• Setting menu items .....	46
• Using the Quick Menu .....	48
About the Setup Menu.....	49

---

---

## Recording

---

---

About the LCD Monitor.....	61
Using the Zoom .....	63
• Using the Optical Zoom/ Using the Extra Optical Zoom (EZ)/ Using the Intelligent Zoom/ Using the Digital Zoom.....	63
Taking Pictures Using the Built-in Flash.....	65
• Switching to the appropriate flash setting .....	65
Taking Close-up Pictures ([AF Macro]/[Macro Zoom]) .....	68
Taking Pictures with the Self-timer.....	69
Compensating the Exposure .....	70
Taking Pictures Using Auto Bracket.....	71
Taking picture by setting the exposure manually (Manual Exposure Mode).....	72
Take the Outdoors Scene Expressively .....	73
• [Sports].....	73
• [Snow] .....	73
• [Beach & Snorkeling].....	74
• [Underwater].....	76

Record pictures that look like dioramas (Miniature Effect Mode).....	77
Taking Pictures that Match the Scene Being Recorded (Scene Mode).....	78
• [Portrait] .....	79
• [Soft Skin].....	79
• [Scenery].....	79
• [Panorama Shot].....	80
• [Night Portrait].....	82
• [Night Scenery] .....	82
• [Handheld Night Shot].....	82
• [Food].....	83
• [Baby1]/[Baby2].....	83
• [Pet].....	84
• [Sunset].....	84
• [High Sens.] .....	84
• [Glass Through] .....	84
Taking 3D pictures (3D Photo Mode).....	85
Taking a Picture with Face Recognition Function .....	86
• Face Settings .....	87
Entering Text.....	90
Using the [Rec] Menu.....	91
• [Aspect Ratio].....	91
• [Picture Size].....	92
• [Quality].....	93
• [Sensitivity].....	94
• [White Balance].....	95
• [AF Mode] .....	98
• [Quick AF] .....	100
• [Face Recog.].....	100
• [i.Exposure] .....	100
• [Min. Shtr Speed] .....	101
• [i.Resolution] .....	102
• [Digital Zoom].....	102
• [Burst].....	103
• [Time Lapse Shot] .....	105
• [Color Mode] .....	108
• [AF Assist Lamp].....	108
• [Red-Eye Removal].....	109
• [Stabilizer] .....	109
• [Date Stamp].....	110
• [Clock Set].....	110

Using the [Motion Picture] Menu .....	111
• [Rec Mode].....	111
• [Rec Quality].....	112
• [Continuous AF] .....	113
• [Wind Cut] .....	113

---



---

## GPS/Sensor

---



---

Recording using the GPS function .....	114
• Acquiring of the GPS information.....	115
• Update the GPS information .....	118
• Change the recorded location name information .....	119
• Switch between displaying and hiding the location name information .....	120
• Register additional landmarks.....	120
Sensors (compass/altimeter/barometer) are operated .....	121
Using the altimeter .....	122
• Adjusting the Altimeter .....	123
• Adding an altimeter log .....	125
• Viewing the altimeter log .....	126
• Deleting the altimeter log .....	127
Using the barometer.....	128
Using the compass.....	129
• Adjusting the compass .....	130
Restricting the GPS/sensor functions....	131
• Disabling the GPS/sensors when the power is turned off.....	131

---

---

## Playback/Editing

---

---

Various methods of playback.....	132
• [Slide Show] .....	133
• [Filtering Play] .....	135
• [Calendar] .....	137
Having Fun with Recorded Pictures.....	138
• [Auto Retouch] .....	138
Using the [Playback] Menu .....	139
• [Upload Set] .....	139
• [Title Edit] .....	141
• [Place-Name Edit] .....	142
• [Text Stamp].....	143
• [Video Divide].....	146
• [Resize] .....	147
• [Cropping] .....	148
• [Favorite] .....	149
• [Print Set] .....	150
• [Protect].....	152
• [Face Rec Edit] .....	153
• [Copy].....	154

Printing the Pictures .....	169
• Selecting a single picture and printing it .....	170
• Selecting multiple pictures and printing them .....	170
• Print Settings .....	171

---

---

## Others

---

---

Screen Display .....	174
Cautions for Use.....	176
Message Display .....	190
Troubleshooting.....	193

---

---

## Connecting to other equipment

---

---

Playing Back Pictures on a TV	
Screen.....	155
• Using VIERA Link (HDMI).....	157
Playing back 3D pictures.....	159
Saving the Recorded Still Pictures and Motion Pictures .....	161
• Copy by inserting the SD card into the recorder .....	161
• Copy the playback image using an AV cable .....	162
• Copying to a PC using “PHOTOfunSTUDIO” .....	163
Connecting to a PC .....	164
• Acquiring of still pictures and [MP4] motion pictures (other than [AVCHD] motion pictures).....	165
• Uploading the images to sharing sites .....	168

Please be sure to read “(Important) About the Waterproof/Dustproof and Anti-shock Performance of the Camera” (P8) before using this unit underwater to prevent the unit from being mishandled, which may cause water to seep in.

## Care of the camera

### ■ Handling of the camera (to prevent water leakage and malfunction)

- Foreign objects may adhere to the inner side of the side door (around the rubber seal or connecting terminals) when the side door is opened or closed in places with sand or dust, etc. This may result in the impairment of the waterproof performance if the side door is closed with foreign objects adhered. Be extremely careful since it may result in malfunction, etc.
- If any foreign object is adhered to the inner side of the side door, remove with the supplied brush.
- If any liquid such as water droplets is adhered to the camera or inner side of the side door, wipe off with a soft, dry cloth. Do not open or close the side door near the water, when underwater, using wet hands, or when the camera is wet. It may cause water leakage.



Do not apply strong shock or vibration by dropping or knocking the camera. Also, do not apply strong pressure to the camera.

e.g.:

- Sit down with the camera in your trousers pocket or forcefully insert it into a full or tight bag, etc.
- Attach any items such as accessories to the strap attached to the camera.
- When strong pressure is applied using the camera at a depth exceeding 12 m (40 feet).
- Waterproof performance may be impaired.
- **Lens or LCD monitor may be damaged.**
- It may cause malfunction in the performance or the function.

■ **When inner side of the lens is fogged (condensation) It is not a malfunction or failure of the camera. It may be caused by the environment in which the camera is used.**

**What to do when inner side of the lens is fogged**

- Turn off the power and open the side door in a place with constant ambient temperature, away from high temperatures, humidity, sand and dust. The fog will disappear naturally in 10 minutes to 2 hours with the side door open when the temperature of the camera gets close to the ambient temperature.
- Contact Panasonic's Service Centre if the fogging does not disappear.

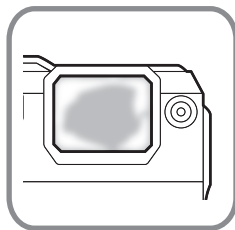

**Conditions in which inner side of the lens may be fogged**

Condensation may occur and the inner side of the lens may be fogged when the camera is used in areas that undergo a significant change in temperature or in high humidity, such as the following:

- **When the camera is used underwater suddenly after being on a hot beach, etc.**
- **When the camera is moved to a warm area from a cold area, such as at a ski resort or at high altitude**
- **When the side door is opened in a high-humidity environment**

## About the GPS

### About the location name information of this unit

Be sure to read the “User License Agreement for Location Name data” on [P184](#) before using.

### When [GPS Setting] is set to [ON], GPS function will operate even when the power is turned off.

- Electromagnetic waves, etc. from this unit may affect other electronic devices, so set [GPS Setting] to [OFF] or [Airplane Mode] to [ON] and turn the power of the unit off during plane takeoff or landing, or in an area where use is prohibited. ([P115](#))
- Battery power is consumed even if the power is turned off when [GPS Setting] is set to [ON].

### About the information of recording location

- Location names of the recording locations or landmarks (such as name of the building, etc.) are as of December 2011. Information will not be updated.
- Depending on the country or the region, there may be less information for location names and landmark names.

### About the positioning

- It will take longer for positioning in an environment where it is harder to receive the radio waves from the GPS satellites. ([P114](#))
- **Even if the receiving condition of the radio waves is excellent, it may take approx. 2 to 3 minutes to complete the positioning when performing positioning for the first time or when you perform positioning after turning on the power again after turning the unit off with the [GPS Setting] set to [OFF] or [Airplane Mode] set to [ON].**
- The positions of the GPS satellites are changing constantly, so positioning may not be performed or the information may have errors depending on the recording location or conditions.
- For details on how to perform positioning smoothly, read “Receiving signals from GPS satellites” on [P114](#).

### When used during overseas travel etc.

- The GPS may not operate in China or close to the Chinese border in neighbouring countries. (As of December 2011)
- The usage of GPS etc., may be restricted depending on the country or the region. This camera has a GPS function, so check with the embassies or travel agencies etc. prior to your overseas travel regarding any restrictions on cameras with a built-in GPS function.

## About the compass, altimeter, depth meter, and barometer

- Information measured on this unit is only a rough indication. Do not use it for technical purposes.
- When using this unit for full-scale mountain climbing, trekking, or underwater, use the measured information (direction, altitude, depth, atmospheric pressure) only as a rough indication, and always carry a map and purpose-built measurement tools.

## **(Important) About the Waterproof/Dustproof and Anti-shock Performance of the Camera**

### **Waterproof/Dustproof Performance**

This camera's waterproof/dustproof rating complies with the "IPX8" and "IP6X" ratings. Provided the care and maintenance guidelines described in this document are strictly followed, this camera can operate underwater, to a depth not exceeding 12 m (40 feet) for a time not exceeding 60 minutes. (\*1)

### **Anti-shock Performance**

This camera also complies with "MIL-STD 810F Method 516.5-Shock". The camera has cleared a drop test from a height of 2 m (6.6 feet) onto 3 cm (0.1 feet) thick plywood. In most cases this camera should not sustain any damage if dropped from a height not exceeding 2 m (6.6 feet). (\*2)

**This does not guarantee no destruction, no malfunction, or waterproofing in all conditions.**

- \*1 This means that the camera can be used underwater for specified time in specified pressure in accordance with the handling method established by Panasonic.
- \*2 "MIL-STD 810F Method 516.5-Shock" is the test method standard of the U.S. Defense Department, which specifies performing drop tests from a height of 122 cm (4 feet), at 26 orientations (8 corners, 12 ridges, 6 faces) using 5 sets of devices, and passing the 26 orientation drops within 5 devices. (If failure occurs during the test, a new set is used to pass the drop orientation test within a total of 5 devices)  
Panasonic's test method is based on the above "MIL-STD 810F Method 516.5-Shock". However, the drop height was changed from 122 cm (4 feet) to 200 cm (6.6 feet) dropping onto 3 cm (0.1 feet) thick plywood. This drop test was passed.  
(Disregarding appearance change such as loss of paint or distortion of the part where drop impact is applied.)

## ■ Handling of the camera

- Waterproofing is not guaranteed if the unit is subject to an impact as a result of being hit or dropped, etc. If an impact to the camera occurs, it should be inspected (subject to a fee) by a Panasonic's Service Centre to verify that the waterproofing is still effective.
- When the camera is splashed with detergent, soap, hot spring, bath additive, sun oil, sun screen, chemical, etc., wipe it off immediately.
- Waterproof function of the camera is for sea water and fresh water only.
- Any malfunction caused by customer misuse, or mishandling will not be covered by the warranty.
- The inside of this unit is not waterproof. Water leakage will cause malfunction.
- Supplied accessories are not waterproof (excluding Hand Strap).
- Card and battery are not waterproof. Do not handle with a wet hand. Also, do not insert wet card or battery into the camera.
- Do not leave the camera for a long period of time in places where temperature is very low (at ski resorts or at high altitude, etc.) or very high [above 40 °C (104 °F)], inside a car under strong sunlight, close to a heater, on the beach, etc. Waterproof performance may be degraded.

## ■ About the [Precautions] demonstration display ([Requirements for Underwater use])

- [Precautions] is displayed when the power is turned on for the first time after purchase, with the side door completely closed.
- Please check beforehand to maintain the waterproof performance.

### 1 Press ◀ to select [Yes], and press [MENU/SET].

- It will automatically skip to the clock setting screen if [No] is selected before it starts.

### 2 Press ◀/▶ to select the picture.

◀: Return to the previous screen

▶: View the next screen

- It can be forcefully ended by pressing [MENU/SET].
- When it is forcefully ended while checking by turning the unit off or pressing [MENU/SET], [Precautions] is displayed every time the power is turned on.

### 3 After the final screen (12/12), press [MENU/SET] to finish.

- When [MENU/SET] is pressed after the final screen (12/12), [Precautions] is not displayed from the next time the power is turned on.
- This can also be viewed from [Precautions] (P49) in the [Setup] menu.

## Check before using underwater

**Do not open or close the side door in places with sand and dust, close to water, or with wet hands. Sand or dust adhering may cause water leaks.**

### 1 Check that there are no foreign objects on the inner side of the side door.

- If there is any foreign object, such as lint, hair, sand, etc., on the surrounding area, water will leak within a few seconds causing malfunction.
- Wipe it off with a soft, dry cloth if there is any liquid.  
It may cause water leaks and malfunction if you use the camera with liquid adhered.
- If there is any foreign material, remove with supplied brush.
- Be extremely careful to remove any sand, etc. that may adhere to the sides and corners of the rubber seal.
- Remove large foreign objects, wet sand, etc., using the shorter (harder) side of the brush.

(A) Brush (supplied)

(B) Side door

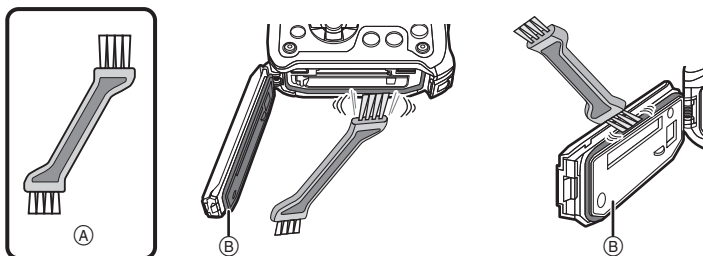

### 2 Check for cracks and deformation of the rubber seal on the side door.

- The integrity of the rubber seals may decrease after about 1 year, with use and age. To avoid permanently damaging the camera the seals should be replaced once each year. Please contact Panasonic's Service Centre for related costs and other information.

### 3 Close the side door securely.

- Lock the [LOCK] switch securely until the red part is no longer visible.
- To prevent water seeping into the camera, be careful not to trap foreign objects such as liquids, sand, hair or dust, etc.

(C) Red part

(D) [LOCK] switch (grey part)

(E) Released state

(F) Locked state

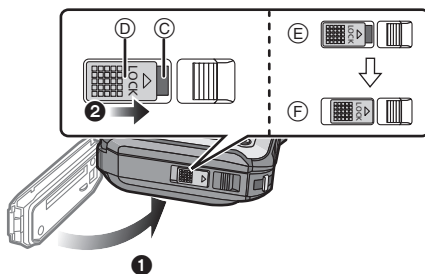

## Using the camera underwater

- Use the camera underwater to 12 m (40 feet) with the water temperature between 0 °C and 40 °C (32 °F and 104 °F).
- Do not use for scuba diving (Aqualung).
- Do not use the camera at a depth of over 12 m (40 feet).
- Do not use it in hot water over 40 °C (104 °F) (in the bath or hot spring).
- Do not use the camera underwater for longer than 60 minutes continuously.
- Do not open or close the side door underwater.
- Do not apply shock to the camera underwater. (Waterproof performance may not be maintained, and there is a chance of water leak.)
- Do not dive into the water holding the camera. Do not use the camera in a location where the water will splash strongly, such as rapid flow or waterfall. (Strong water pressure may be applied, and it may cause malfunction.)
- The camera will sink in the water. Take care not to drop the camera and lose it underwater by securely placing the strap around your wrist or similar measure.

## Caring of the camera after using it underwater

**Do not open or close the side door until the sand and dust is removed by rinsing the camera with water.**

**Make sure to clean the camera after using it.**

- Thoroughly wipe off any water droplets, sand, and saline matter on your hands, body, hair, etc.
- It is recommended to clean the camera indoors, avoiding places where water spray or sand may fall.

**After using it underwater, always clean the camera rather than leaving it in a dirty state.**

- Leaving the camera with foreign objects or saline matter on it may cause damage, discolouration, corrosion, unusual odour, or deterioration of the waterproof performance.

### **1 Rinse with water with the side door closed.**

- After use at the seaside or underwater, soak the unit in fresh water pooled in a shallow container for about 10 minutes.
- If the zoom button or camera [ON/OFF] button do not move smoothly, it may be caused by an adhesion of foreign objects. Using in such a state may cause malfunctions, such as locking up, so wash off any foreign objects by shaking the camera in fresh water.
- Bubbles may come out of the drainage hole when you immerse the camera in water, but this is not a malfunction.



**2 Drain water by holding the camera upside down and shaking it lightly a few times.**

- After using the camera at the seaside or under water, or after washing it, water will remain at the speaker site of the camera for a while and it may cause lower sound or sound distortion.
- Fasten the strap firmly to prevent the camera from dropping.

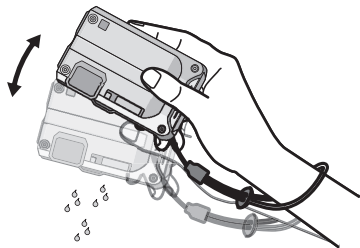

**3 Wipe off water drops on the camera with a soft, dry cloth and dry the camera in a shaded area that is well ventilated.**

- Dry the camera by standing it on a dry cloth. This unit incorporates drain design, draining water in gaps in the camera [ON/OFF] button and zoom button, etc.
- Do not dry the camera with hot air from dryer or similar. Waterproof performance will deteriorate due to deformation.
- Do not use chemicals such as benzine, thinner, alcohol or cleanser, soap or detergents.



**4 Confirm that there are no water droplets, open the side door, and wipe off any water droplets or sand left inside using a soft, dry cloth.**

- Water droplets may adhere to the card or battery when the side door is opened without thoroughly drying. Also, water may accumulate in the gap around the card/battery slot or the terminal connector. Be sure to wipe any water off with a soft, dry cloth.
- The water droplets may seep into the camera when the side door is closed while it is still wet, causing condensation or failure.

## Standard Accessories

Check that all the accessories are supplied before using the camera.

- Supplied accessories are not waterproof (excluding Hand Strap).
- Keep the Brush out of reach of children to prevent swallowing.
- The accessories and their shape will differ depending on the country or area where the camera was purchased.  
For details on the accessories, refer to Basic Operating Instructions.
- Battery Pack is indicated as **battery pack** or **battery** in the text.
- Battery Charger is indicated as **battery charger** or **charger** in the text.
- SD Memory Card, SDHC Memory Card and SDXC Memory Card are indicated as **card** in the text.
- **The card is optional.**  
**You can record or play back pictures on the built-in memory when you are not using a card.**
- Consult the dealer or your nearest Service Centre if you lose the supplied accessories. (You can purchase the accessories separately.)

## Names of the Components

- 1 Flash (P65)
- 2 GPS status indicator (P115)
- 3 Motion picture button (P38)
- 4 Shutter button (P32, 35)
- 5 Camera [ON/OFF] button (P27)
- 6 Self-timer indicator (P69)/  
AF Assist Lamp (P108)/  
LED light (P55)
- 7 GPS antenna (P114)
- 8 Microphone
- 9 Lens (P6, 180, 197)

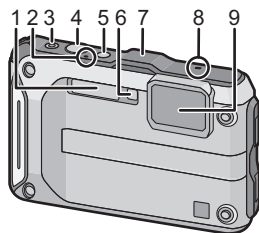

- 10 LCD monitor (P61, 174, 179)
- 11 Speaker (P52)
- 12 Zoom button (P63)
- 13 [▶] (Playback) button (P40)
- 14 Strap eyelet (P16)
  - Be sure to attach the strap when using the camera to ensure that you will not drop it.
- 15 Release lever (P21)
- 16 [LOCK] switch (P10, 21)
- 17 Side door (P10, 21, 22)
- 18 [MODE] button (P30, 132)
- 19 [Q.MENU] (P48)/[⌫/↵] (Delete/Cancel) button (P44)
- 20 [DISP.] button (P61)
- 21 [MENU/SET] button (P46)

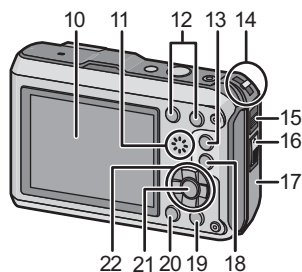

- 22 Cursor buttons
  - Ⓐ: ▲/Exposure compensation (P70)  
Auto Bracket (P71)
  - Ⓑ: ▼/Macro Mode (P68)  
AF Tracking (P99)
  - Ⓒ: ◀/Self-timer (P69)
  - Ⓓ: ▶/Flash setting (P65)

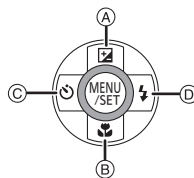

In these operating instructions, the cursor buttons are described as shown in the figure below or described with ▲/▼/◀/▶.  
e.g.: When you press the ▼ (down) button



or Press ▼

---

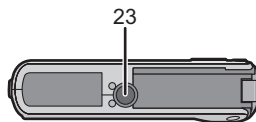
**23 Tripod receptacle**

---

**24 [HDMI] socket (P155, 157)**

- Do not connect with any cable other than an HDMI micro cable (RP-CHEU15: optional). Doing so may cause malfunction.

**25 Card slot (P21)****26 [AV OUT/DIGITAL] socket (P155, 162, 165, 169)****27 Battery slot (P21)**

- When using an AC adaptor, ensure that the Panasonic DC coupler (optional) and AC adaptor (optional) are used. For connection details, refer to P22.

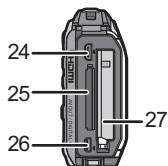

## Attaching the Strap

### 1 Run the strap through the strap eyelet on the camera.

- If the strap cord is loose, it may snag when the side door is opened or closed. Since damage or leaks may result, be sure to attach the cord firmly, checking that it is not snagged in the side door.

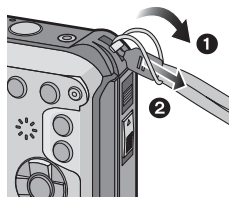

### 2 Pass your hand through the strap and adjust its length.



#### Note

- Attach the strap correctly following the procedure.
- The camera will sink in the water, so use it underwater securely fastening the strap around your wrist.
- Do not swing around or pull forcefully on the unit with the strap attached. The strap may break.

## Charging the Battery

### ■ About batteries that you can use with this unit

It has been found that counterfeit battery packs which look very similar to the genuine product are made available to purchase in some markets. Some of these battery packs are not adequately protected with internal protection to meet the requirements of appropriate safety standards. There is a possibility that these battery packs may lead to fire or explosion. Please be advised that we are not liable for any accident or failure occurring as a result of use of a counterfeit battery pack. To ensure that safe products are used, we would recommend that a genuine Panasonic battery pack is used.

- Use the dedicated charger and battery.

### Charging

- The battery is not charged when the camera is shipped. Charge the battery before use.
- Charge the battery with the charger indoors.
- Charge the battery in areas with an ambient temperature between 10 °C and 30 °C (50 °F and 86 °F) (same as the battery temperature) is recommended.

- 1 Attach the battery, paying attention to the direction of the battery.

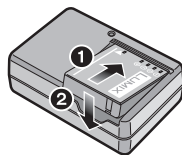

- 2 Connect the charger to the electrical outlet.

- The [CHARGE] indicator (A) lights up and charging begins.

plug-in type

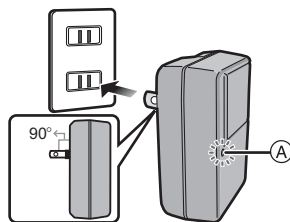

inlet type

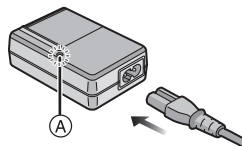

## ■ About the [CHARGE] indicator

**On:** Charging.

**Off:** Charging has completed. (Disconnect the charger from the electrical socket and detach the battery after charging is completed.)

### • When the [CHARGE] indicator flashes

- The battery temperature is too high or too low. It is recommended to charge the battery again in an ambient temperature between 10 °C and 30 °C (50 °F and 86 °F).
- The terminals of the charger or the battery are dirty. In this case, wipe off the dirt with a dry cloth.

## ■ Charging time

Charging time	Approx. 130 min
---------------	-----------------

- The indicated charging time is for when the battery has been discharged completely. The charging time may vary depending on how the battery has been used. The charging time for the battery in hot/cold environments or a battery that has not been used for long time may be longer than normal.

## ■ Battery indication

The battery indication is displayed on the LCD monitor.



- The indication turns red and blinks if the remaining battery power is exhausted. Recharge the battery or replace it with a fully charged battery.

### Note

- **Do not leave any metal items (such as clips) near the contact areas of the power plug. Otherwise, a fire and/or electric shocks may be caused by short-circuiting or the resulting heat generated.**
- The battery becomes warm after using it and during and after charging. The camera also becomes warm during use. This is not a malfunction.
- The battery can be recharged even when it still has some charge left, but it is not recommended that the battery charge be frequently topped up while the battery is fully charged. (Since characteristic swelling may occur.)

## Approximate operating time and number of recordable pictures

### ■ Recording still pictures

<b>Number of recordable pictures</b>	<b>Approx. 310 pictures</b>	(By CIPA standard in Programme AE Mode)
<b>Recording time</b>	<b>Approx. 155 min</b>	

#### Recording conditions by CIPA standard

- CIPA is an abbreviation of [Camera & Imaging Products Association].
- Temperature: 23 °C (73.4 °F)/Humidity: 50%RH when LCD monitor is on.
- Using a Panasonic SD Memory Card (32 MB).
- Using the supplied battery.
- Starting recording 30 seconds after the camera is turned on. (When the Optical Image Stabiliser function is set to [ON].)
- **Recording once every 30 seconds** with full flash every second recording.
- Changing the zoom magnification from Tele to Wide or vice versa in every recording.
- Turning the camera off every 10 recordings and leaving it until the temperature of the battery decreases.
- Not using the GPS function.

**The number of recordable pictures varies depending on the recording interval time. If the recording interval time becomes longer, the number of recordable pictures decreases. [For example, if you were to take one picture every two minutes, then the number of pictures would be reduced to approximately one-quarter of the number of pictures given above (based upon one picture taken every 30 seconds).]**

## ■ Recording motion pictures

	<b>[AVCHD]</b> (Recording with picture quality set to [FSH])	<b>[MP4]</b> (Recording with picture quality set to [FHD])
<b>Recordable time</b>	<b>Approx. 100 min</b>	<b>Approx. 100 min</b>
<b>Actual recordable time</b>	<b>Approx. 50 min</b>	<b>Approx. 50 min</b>

- These times are for an ambient temperature of 23 °C (73.4 °F) and a humidity of 50%RH. Please be aware that these times are approximate.
- Time of recording without using the GPS function.
- Actual recordable time is the time of recording possible with repeated on/off of the power, start/stop of the recording, and zoom operations, etc.
- Maximum time to record motion pictures continuously with [GFS]/[FSH] in [AVCHD] is 29 minutes 59 seconds.
- Maximum time to record motion pictures continuously with [MP4] is 29 minutes 59 seconds. Also, motion pictures recorded continuously in [MP4] is up to 4 GB. Given this constraint, the maximum length of continuous recording in [FHD] is approximately 24 minutes 48 seconds. The maximum available recording time continuously is displayed on the screen.

## ■ Playback

<b>Playback time</b>	<b>Approx. 300 min</b>
----------------------	------------------------

### Note

- **The operating times and number of recordable pictures will differ according to the environment and the operating conditions.**  
For example, in the following cases, the operating times shorten and the number of recordable pictures is reduced.
  - At low temperature or in cold locations such as ski resorts or at high altitude\*
  - \* **Residual image may show on the LCD display when in use. The battery performance will decrease, so keep the camera and spare batteries warm by placing them in a warm place such as inside your cold protection gear or clothing. Performance of batteries and LCD monitor will restore to normal when the temperature returns to normal.**
  - When using [LCD Mode].
  - When operations such as flash and zoom are used repeatedly.
  - When the GPS function is operating.
- When the operating time of the camera becomes extremely short even after properly charging the battery, the life of the battery may have expired. Buy a new battery.

## Inserting and Removing the Card (optional)/the Battery

- Check that this unit is turned off.
- **Confirm that there is no foreign object. (P10)**
- We recommend using a Panasonic card.

**1** ①: Slide the [LOCK] switch (A), and release the lock.

②: Slide the release lever (B) and open the side door.

- Always use genuine Panasonic batteries.
- If you use other batteries, we cannot guarantee the quality of this product.

**2** **Battery:** Being careful about the battery orientation, insert all the way until you hear a locking sound and then check that it is locked by lever (C). Pull the lever (C) in the direction of the arrow to remove the battery.

**Card:** Push it securely all the way until you hear a “click” while being careful about the direction in which you insert it. To remove the card, push the card until it clicks, then pull the card out upright.

ⓓ: Do not touch the connection terminals of the card.

**3** **Close the side door until it clicks, and then lock the [LOCK] switch by sliding it toward [▶].**

- Confirm that the red part on the [LOCK] switch is not showing.

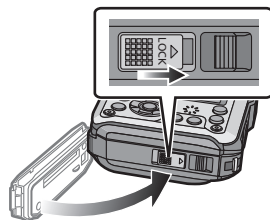
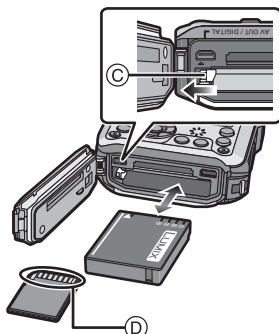
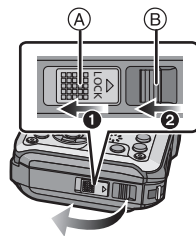

### Note

- Remove the battery after use. (The battery will be exhausted if left for a long period of time after being charged.)
- Turn the camera off and wait for the "LUMIX" display on the LCD monitor to clear before removing the card or battery. (Otherwise, this unit may no longer operate normally and the card itself may be damaged or the recorded pictures may be lost.)

### About the water leakage warning message

To maintain the waterproof performance of this unit, a message prompting to check for any foreign material inside the side door or to perform maintenance is displayed along with a warning sound when the following are performed. (P192)

- When the power is turned on after opening the side door and replacing the card.
- When the power is turned on after opening the side door and replacing the battery.

### Note

- After opening the side door, close it securely taking care not to get any foreign objects caught.
- If there is any foreign object, remove it with attached brush.
- Warning message display can be turned off by pressing any button.

### Using an AC adaptor (optional) and a DC coupler (optional) instead of the battery

The AC adaptor (optional) can only be used with the designated Panasonic DC coupler (optional). The AC adaptor (optional) cannot be used by itself.

- 1 Open the side door (A).
  - 2 Insert the DC coupler, being careful of the direction.
  - 3 Plug the AC adaptor into an electrical outlet.
  - 4 Connect the AC adaptor (B) to the [DC IN] socket (C) of the DC coupler.
- Ensure that only the AC adaptor and DC coupler for this camera are used. Using any other equipment may cause damage.

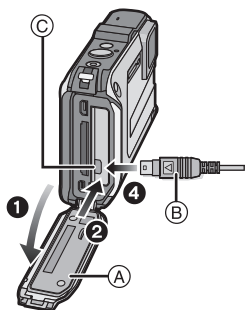

### Note



- Always use a genuine Panasonic AC adaptor (optional).
- When using an AC adaptor, use the AC cable supplied with the AC adaptor.
- Side door cannot be closed while the AC adaptor is connected.
- Some tripods cannot be attached when the DC coupler is connected.
- **Do not apply any force to the side door with the weight of the cable or your hand when the AC adaptor is connected. It may cause damage.**
- **The DC coupler may get disconnected from this unit if a cable is pulled when connecting the AC adaptor, so take caution.**
- Before removing the DC coupler, turn the camera off and disconnect the AC adaptor.
- Also read the operating instructions for the AC adaptor and DC coupler.
- Waterproof/dustproof function does not operate when the AC adaptor is connected.

## About the Built-in Memory/the Card

The following operations can be performed using this unit:

When a card has not been inserted	Pictures can be recorded on the built-in memory and played back.
When a card has been inserted	Pictures can be recorded on the card and played back.

### • When using the built-in memory:

 →  (access indication<sup>\*</sup>)

### • When using the card:

 (access indication<sup>\*</sup>)

- \* The access indication is displayed in red when pictures are being recorded on the built-in memory (or the card).



## Built-in Memory

- You can copy the recorded pictures to a card. (P154)
- **Memory size: Approx. 20 MB**
- The access time for the built-in memory may be longer than the access time for a card.

## Card

The following cards which conform to the SD video standard can be used with this unit. (These cards are indicated as **card** in the text.)

	Remarks
<b>SD Memory Card (8 MB to 2 GB)</b>	<ul style="list-style-type: none"> <li>• Use a card with SD Speed Class* with “Class 4” or higher when recording motion pictures.</li> <li>• SDHC Memory Card can be used with SDHC Memory Card or SDXC Memory Card compatible equipment.</li> <li>• SDXC Memory Card can only be used with SDXC Memory Card compatible equipment.</li> <li>• Check that the PC and other equipment are compatible when using the SDXC Memory Cards. <a href="http://panasonic.net/avc/sdcard/information/SDXC.html">http://panasonic.net/avc/sdcard/information/SDXC.html</a></li> <li>• Only the cards with capacity listed left can be used.</li> </ul>
<b>SDHC Memory Card (4 GB to 32 GB)</b>	
<b>SDXC Memory Card (48 GB, 64 GB)</b>	

\* SD Speed Class is the speed standard regarding continuous writing. Check via the label on the card, etc.

e.g.:

CLASS 4

4

• Please confirm the latest information on the following website.

<http://panasonic.jp/support/global/cs/dsc/>

(This Site is English only.)

### Note

• Do not turn this unit off, remove its battery or card, or disconnect the AC adaptor (optional) during access (when pictures are being written, read or deleted, or the built-in memory or the card is being formatted). Furthermore, do not subject the camera to vibration, impact or static electricity.

The card or the data on the card may be damaged, and this unit may no longer operate normally.

If operation fails due to vibration, impact or static electricity, perform the operation again.

- Write-Protect switch (A) provided (When this switch is set to the [LOCK] position, no further data writing, deletion or formatting is possible. The ability to write, delete and format data is restored when the switch is returned to its original position.)
- The data on the built-in memory or the card may be damaged or lost due to electromagnetic waves, static electricity or breakdown of the camera or the card. We recommend storing important data on a PC, etc.
- Do not format the card on your PC or other equipment. Format it on the camera only to ensure proper operation. (P60)
- Keep the Memory Card out of reach of children to prevent swallowing.

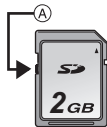

## Approximate number of recordable pictures and available recording time

### ■ About the display of the number of recordable pictures and available recording time

- You can confirm the number of recordable pictures and available recording time by pressing [DISP.] several times. (P61)

- (A) Number of recordable pictures
- (B) Available recording time



- The number of recordable pictures and the available recording time are an approximation. (These vary depending on the recording conditions and the type of card.)
- The number of recordable pictures and the available recording time varies depending on the subjects.

### ■ Number of recordable pictures

- [+99999] is displayed if there are more than 100,000 pictures remaining.
- Aspect ratio [4:3], Quality [S&L]

[Picture Size]	Built-in Memory (Approx. 20 MB)	2 GB	32 GB	64 GB
12M	3	380	6260	12670
5M (EZ)	7	650	10620	21490
0.3M (EZ)	120	10050	162960	247150

## ■ Available recording time (when recording motion pictures)

• “h” is an abbreviation for hour, “m” for minute and “s” for second.

### • [AVCHD]

[Rec Quality]	Built-in Memory (Approx. 20 MB)	2 GB	32 GB	64 GB
<b>GFS</b>	–	15m00s	4h10m00s	8h27m00s
<b>FSH</b>	–	15m00s	4h10m00s	8h27m00s
<b>GS</b>	–	15m00s	4h10m00s	8h27m00s
<b>SH</b>	–	15m00s	4h10m00s	8h27m00s

### • [MP4]

[Rec Quality]	Built-in Memory (Approx. 20 MB)	2 GB	32 GB	64 GB
<b>FHD</b>	–	12m26s	3h23m22s	6h51m21s
<b>HD</b>	–	23m45s	6h28m15s	13h05m20s
<b>VGA</b>	20s	52m17s	14h14m28s	28h48m24s

### Note

- Number of recordable pictures/available recording time for the card may decrease when [Upload Set] is performed.
- Maximum time to record motion pictures continuously with [GFS]/[FSH] in [AVCHD] is 29 minutes 59 seconds.
- Maximum time to record motion pictures continuously with [MP4] is 29 minutes 59 seconds. Also, motion pictures recorded continuously in [MP4] is up to 4 GB. Given this constraint, the maximum length of continuous recording in [FHD] is approximately 24 minutes 48 seconds. The maximum available recording time continuously is displayed on the screen.

## Setting Date/Time (Clock Set)

- The clock is not set when the camera is shipped.

### 1 Press camera [ON/OFF] button.

- If the language select screen is not displayed, proceed to [Requirements for Underwater use] below.

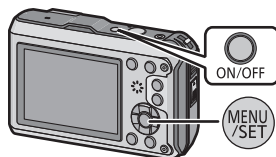

### 2 Press [MENU/SET].

### 3 Press ▲/▼ to select the language, and press [MENU/SET].

#### [Requirements for Underwater use]

Be sure to check this so that you can maintain the waterproof performance.  
 [Please set the clock] is displayed after viewing the last screen.  
 For details, refer to P9.

### 4 Press [MENU/SET].



### 5 Press ◀/▶ to select the items (year, month, day, hour, minute, display sequence or time display format), and press ▲/▼ to set.

- (A): Time at the home area
- (B): Time at the travel destination

- You can cancel without setting the clock by pressing [Cancel].

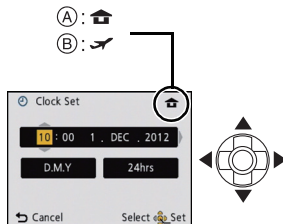

**6 Press [MENU/SET].**

- Confirmation screen is displayed. Press [MENU/SET].

**7 Select [Yes] to automatically correct the clock, and then press [MENU/SET].**

- Message screen is displayed. Press [MENU/SET].

**8 Press ◀/▶ to select the home area, and then press [MENU/SET].**

- Confirmation screen to operate the altimeter, barometer and compass is displayed. Select [Yes] to operate them.



### Changing the clock setting

#### Select [Clock Set] in the [Rec] or [Setup] menu, and press [MENU/SET]. (P46)

- The clock can be reset as shown in steps 5 and 6.
- **The clock setting is maintained for 3 months using the built-in clock battery even without the battery. (Leave the charged battery in the unit for 24 hours to charge the built-in battery.)**

#### Note

- If the clock is not set, the correct date cannot be printed when you order a photo studio to print the picture, or when you stamp the date on the pictures with [Date Stamp] (P110) or [Text Stamp] (P143).
- If the clock is set, the correct date can be printed even if the date is not displayed on the screen of the camera.
- **When [GPS Setting] is set to [ON], the GPS function will operate even when the power is turned off. Electromagnetic waves, etc. from this unit may affect other electronic devices, so set [GPS Setting] to [OFF] or [Airplane Mode] to [ON] and turn the unit off when you carry this unit onboard an airplane or inside a hospital, etc.**

## Tips for taking good pictures

### Fit the strap and hold the camera carefully

Hold the camera gently with both hands, keep your arms still at your side and stand with your feet slightly apart.

- To prevent dropping, be sure to attach the supplied strap and fit it to your wrist. (P16)
- Be careful not to move the camera when you press the shutter button.
- Be careful not to put your fingers on the flash, AF Assist Lamp/LED light, microphone or lens, etc.

- (A) Strap
- (B) Flash
- (C) AF Assist Lamp/LED light
- (D) Microphone

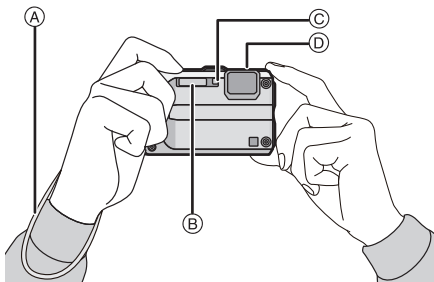

### ■ Direction Detection Function ([Rotate Disp.])

Pictures recorded with the camera held vertically are played back vertically (rotated). (Only when [Rotate Disp.] (P59) is set)

- When the camera is held vertically and tilted up and down to record pictures, the Direction Detection function may not work correctly.
- Motion pictures taken with the camera held vertically are not displayed vertically.

### Preventing jitter (camera shake)

When the Jitter alert ([Jitter]) appears, use [Stabilizer] (P109), a tripod or the Self-timer (P69).

- Shutter speed will be slower particularly in the following cases. Keep the camera still from the moment the shutter button is pressed until the picture appears on the screen. We recommend using a tripod.
  - Slow sync./Red-Eye Reduction
  - In [Night Portrait] or [Night Scenery] in Scene Mode
  - When the shutter speed is slowed in [Min. Shtr Speed]

## Selecting the Recording Mode

**1** Press [MODE].

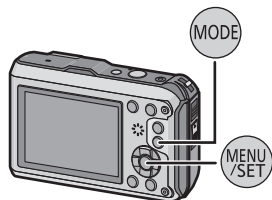







**2** Press ▲/▼/◀/▶ to select the Recording Mode.



**3** Press [MENU/SET].

## ■ List of Recording Modes

<b>P</b>	<b>Programme AE Mode (P32)</b>
	The subjects are recorded using your own settings.
	<b>Intelligent Auto Mode (P35)</b>
	The subjects are recorded using settings automatically selected by the camera.
<b>M</b>	<b>Manual Exposure Mode (P72)</b>
	The exposure is adjusted by the aperture value and the shutter speed which are manually adjusted.
	<b>Sports Mode (P73)</b>
	Use this mode to take pictures of sporting events, etc.
	<b>Snow Mode (P73)</b>
	This allows you to take pictures that show the snow as white as possible at a ski resort or a snow-covered mountain.
	<b>Beach &amp; Snorkeling Mode (P74)</b>
	This mode is optimal for taking pictures underwater and at the beach.
	<b>Underwater Mode (P76)</b>
	This is optimal for taking pictures underwater deeper than 12 m (40 feet) by the use of the marine case (DMW-MCFT3: optional).
	<b>Miniature Effect Mode (P77)</b>
	This is an imaging effect which defocuses the surroundings to make it look like a diorama. (also known as Tilt Shift Focus)
<b>SCN</b>	<b>Scene Mode (P78)</b>
	This allows you to take pictures that match the scene being recorded.
<b>3D</b>	<b>3D Photo Mode (P85)</b>
	Takes a 3D picture.

### Note

- When the mode has been switched from Playback Mode to Recording Mode, the previously set Recording Mode will be set.

Recording Mode: **P**

## Taking Pictures with Your Favourite Settings (Program AE Mode)

The camera automatically sets the shutter speed and the aperture value according to the brightness of the subject.

You can take pictures with greater freedom by changing various settings in the [Rec] menu.

**1** Press [MODE].

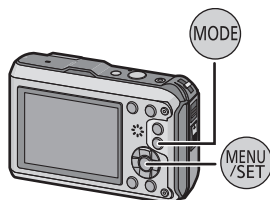

**2** Press  $\blacktriangle/\blacktriangledown/\blacktriangleleft/\blacktriangleright$  to select [Program AE], and then press [MENU/SET].



**3** Aim the AF area at the point you want to focus on.

**4** Press the shutter button halfway to focus.

- (A) ISO sensitivity
- (B) Aperture value
- (C) Shutter speed

- The focus indication (D) (green) lights when the subject is focused.
- Aperture value and shutter speed is displayed in red when correct exposure is not achieved. (Except when using a flash)

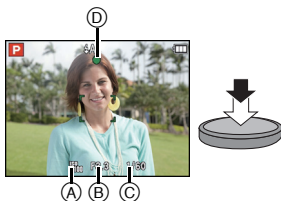

**5** Press the halfway pressed shutter button fully to take a picture.



## Focusing

Aim the AF area at the subject, and then press the shutter button halfway.

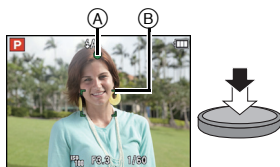

Focus	When the subject is focused	When the subject is not focused
Focus indication (A)	On	Blinks
AF area (B)	White → Green	White → Red
Sound	Beeps 2 times	Beeps 4 times

• The AF area may be displayed larger for certain zoom magnifications and in dark places.

### ■ About focus range

The focus range is displayed when operating the zoom.

• The focus range is displayed in red when it is not focused after pressing the shutter button halfway.

The focus range may change gradually depending on the zoom position.

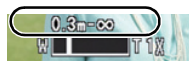

e.g.: Range of focus during the Intelligent Auto Mode

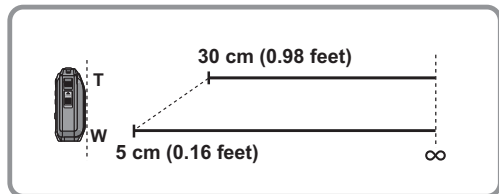

■ When the subject is not in focus (such as when it is not in the centre of the composition of the picture you want to take)

- 1** Aim the AF area at the subject, and press the shutter button halfway to fix the focus and exposure.
- 2** Press and hold the shutter button halfway while moving the camera as you compose the picture.

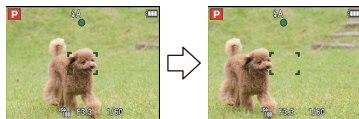

- You can repeatedly retry the actions in step **1** before pressing the shutter button fully.

■ Subject and recording conditions which are difficult to focus in

- Fast-moving subjects, extremely bright subjects or subjects without contrast
- When recording subjects through windows or near shiny objects
- When it is dark or when jitter occurs
- When the camera is too close to the subject or when taking a picture of both distant and near subjects

Recording Mode: 

## Taking Pictures Using the Automatic Function (Intelligent Auto Mode)

The camera will set the most appropriate settings to match the subject and the recording conditions so we recommend this mode for beginners or those who want to leave the settings to the camera and take pictures easily.

- The following functions are activated automatically.
  - Scene Detection/Backlight Compensation/Intelligent ISO sensitivity control/Auto White Balance/Face Detection/[Quick AF]/[i.Exposure]/[i.Resolution]/[i.ZOOM]/[AF Assist Lamp]/[Red-Eye Removal]/[Stabilizer]/[Continuous AF]
- Image quality is fixed to .

**1** Press [MODE].

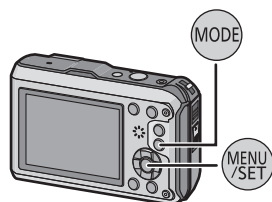

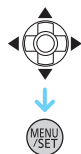

**2** Press /// to select [Intelligent Auto], and then press [MENU/SET].



**3** Press the shutter button halfway to focus and then press it fully to take the picture.

(A) Focus indication



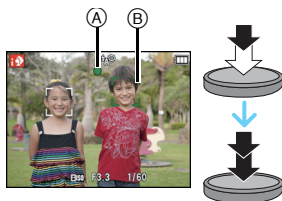



- The AF area (B) is displayed around the subject's face by the Face Detection function. In other cases, it is displayed at the point on the subject which is in focus.
- You can set the AF tracking by pressing . For details, refer to P99. (AF tracking is cancelled by pressing  again)
- The minimal distance (how close you can be to the subject) will change depending on the zoom factor. Please check with the recordable range display on the screen. (P33)



## Scene Detection

When the camera identifies the optimum scene, the icon of the scene concerned is displayed in blue for 2 seconds, after which its colour changes to the usual red.





### When taking pictures

iA →	 [i-Portrait]	 [i-Scenery]
	 [i-Macro]	 [i-Night Portrait]* <sup>1</sup>
	 [i-Night Scenery]	 [i-Sunset]
	 [i-Baby]* <sup>2</sup>	

\*1 Only when [iA] is selected.

\*2 When [Face Recog.] is set to [ON], [iA] will be displayed for birthdays of registered faces already set only when the face of a person 3 years old or younger is detected.

### When recording motion pictures

iA →	 [i-Portrait]	 [i-Scenery]
	 [i-Low Light]	 [i-Macro]

- [iA] is set if none of the scenes are applicable, and the standard settings are set.
- When [iA], [iA] or [iA] is selected, the camera automatically detects a person's face, and it will adjust the focus and exposure. **(Face Detection)**
- If a tripod is used, for instance, and the camera has judged that camera shake is minimal when the Scene Mode has been identified as [iA], the shutter speed will be set to a maximum of 8 seconds. Take care not to move the camera while taking pictures.
- When [Face Recog.] is set to [ON], and the face similar to the registered face is detected, [R] is displayed in the top right of [iA], [iA] and [iA].
- Due to conditions such as the ones below, a different scene may be identified for the same subject.
  - Subject conditions: When the face is bright or dark, the size of the subject, the colour of the subject, the distance to the subject, the contrast of the subject, when the subject is moving
  - Recording conditions: Sunset, sunrise, under low brightness conditions, underwater, when the camera is shaken, when zoom is used
- For the best results, it is recommended that you take pictures in the appropriate Recording Mode.
- Face Detection may become slower or it may not detect underwater.
- **The Backlight Compensation**
  - Backlight refers to when light comes from the back of a subject. In this case, the subject will become dark, so this function compensates the backlight by brightening the picture. In Intelligent Auto Mode, backlight compensation works automatically. The [iA] is displayed on the screen when backlighting is detected. The actual backlighting conditions and [iA] may not always match.

## Changing the settings

Following menus can be set.

Menu	Item
[Rec]	[Picture Size]*/[Burst]*/[Time Lapse Shot]/[Color Mode]*/[Motion Deblur]/[Face Recog.]
[Motion Picture]	[Rec Mode]/[Rec Quality]
[GPS/Sensor]	[GPS Setting]/[Repositioning]/[Sensor Settings]/[Airplane Mode]/[GPS Area Select]/[Area Info. Set]/[My Landmark]/[Altimeter]/[Calibrate compass]
[Setup]	[Clock Set]/[World Time]/[Beep]*/[LED Light]/[Language]/[Stabilizer Demo.]

• For the setting method of the menu, refer to P46.

\* Settings may be different from other Recording Modes.

### Menus specific to Intelligent Auto Mode









#### ■ [Color Mode]

– Colour setting of [Happy] is available in [Color Mode]. It is possible to automatically take a picture with a higher level of brilliance for the colour brightness and vividness.

#### ■ [Motion Deblur]

– When [Motion Deblur] is set to [ON], [,] is displayed on the recording screen. The camera automatically sets an optimal shutter speed according to the motion of the subject to reduce blur on the subject. (In such a case, the number of pixels may be reduced.)

### About the flash (P65)

- When [A] is selected, [A], [A<sup>Ⓞ</sup>], [S<sup>Ⓞ</sup>] or [S] is set depending on the type of subject and brightness.
- When [A<sup>Ⓞ</sup>], [S<sup>Ⓞ</sup>] is set, Digital Red-Eye Correction is enabled.
- Shutter speed will be slower during [S<sup>Ⓞ</sup>] or [S].

Applicable modes: 

## Recording Motion Pictures

### 1 Start recording by pressing the motion picture button.

- (A) Available recording time
- (B) Elapsed recording time

- You can record motion pictures fitting each Recording Mode.
- Release the motion picture button right after you press it.
- The recording state indicator (red) (C) will flash while recording motion pictures.
- For the setting of the [Rec Mode] and [Rec Quality], refer to P111.

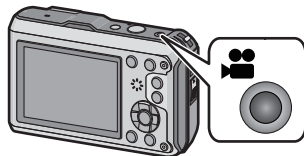

### 2 Stop the recording by pressing the motion picture button again.

#### ■ About the recording format for recording motion pictures

This unit can record motion pictures in either AVCHD or MP4 formats.

#### AVCHD:

You can record high definition quality images with this format. It is suitable for viewing on a large format TV or for saving to disc.

#### MP4:

This is a simpler video format best used when extensive editing is needed, or when uploading videos to the internet.

#### ■ About the compatibility of the recorded motion pictures

Motion pictures recorded in [AVCHD] or [MP4] may be played back with poor picture or sound quality or playback may not be possible even when played back with equipment compatible with these formats. Also, the recording information may not be displayed properly. In this case, use this unit.

- For details on MP4 compatible devices, refer to the support sites below.

<http://panasonic.jp/support/global/cs/dsc/>

(This Site is English only.)

 **Note**

- When recording to the built-in memory, the [MP4] setting is fixed to [VGA].
- The available recording time displayed on the screen may not decrease regularly.
- Depending on the type of the card, the card access indication may appear for a while after recording motion pictures. This is not a malfunction.
- The screen may be blacked out momentarily, or the unit may record noise due to static electricity or electromagnetic waves, etc. depending on the environment of the Motion Picture Recording.
- Even if the aspect ratio setting is the same in still pictures and motion pictures, the angle of view may change at the start of the motion picture recording.  
When [Video Rec Area] (P54) is set to [ON], angle of view during motion picture recording is displayed.
- **About zooming while recording motion pictures**
  - If the Extra Optical Zoom was used before pressing the motion picture button, settings will be cancelled, and the recordable range will change drastically.
  - If you operate the zoom etc. while recording motion pictures, the sound of the operation may be recorded.
  - The zoom speed will be slower than usual when recording motion pictures.
  - Operating the zoom while recording motion pictures can take time for the image to come into focus.
- If you end motion picture recording after a short time when using Miniature Effect Mode, the camera may go on recording for a certain period. Continue to hold the camera until the recording ends.
- Noise may be recorded underwater.
- It is recommended to use a fully charged battery or AC adaptor (optional) when recording motion pictures.
- If while recording motion pictures using the AC adaptor (optional) and the power supply is cut off due to a power outage or if the AC adaptor (optional) is disconnected, etc., the motion picture being recorded will not be recorded.
- Motion pictures cannot be recorded in the following cases.
  - In [Panorama Shot] in Scene Mode
  - When using [Time Lapse Shot]
- A sound might be muffled or warped when there is water on the microphone or the speaker. Wipe the residue after letting the water drip out from the microphone and speaker by tipping it down, and use it only after letting it dry for a while. (P180)
- It will be recorded in following categories for certain Recording Modes. A motion picture recording matching each Recording Mode will be performed for the ones not listed below.

Selected Recording Mode	Recording Mode while recording motion picture
• [Baby1]/[Baby2] in Scene Mode	Portrait Mode
• [Night Portrait], [Night Scenery] and [Handheld Night Shot] in Scene Mode	Low Light Mode
• Programme AE Mode • Manual Exposure Mode • [Sports] • [Pet] in Scene Mode	Normal Motion Picture

## Playing Back Pictures ([Normal Play])

### Press [▶].

- Normal Playback is displayed automatically when the power is turned on by pressing and holding the [▶] button.

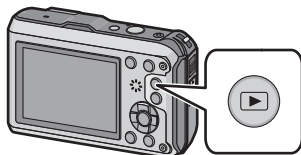

### Note

- This camera complies with the DCF standard “Design rule for Camera File system” established by JEITA “Japan Electronics and Information Technology Industries Association” and with Exif “Exchangeable Image File Format”. Files which do not comply with the DCF standard cannot be played back.
- Pictures recorded with other cameras may not be able to play back on this unit.

## Selecting a picture

### Press ◀ or ▶.

- ◀: Play back the previous picture
- ▶: Play back the next picture

- Ⓐ File number
- Ⓑ Picture number

- If you press and hold ◀/▶, you can play back the pictures in succession.
- Speed of picture forwarding/rewinding changes depending on the playback status.

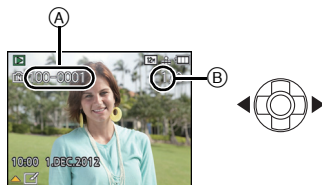

## Displaying Multiple Screens (Multi Playback)

### Press [W] on the zoom button.

1 screen → 12 screens → 30 screens → Calendar screen display

(A) Number of the selected picture and the total number of recorded pictures

- Press [T] on the zoom button to return to the previous screen.
- Pictures displayed using [[?/?]] cannot be played back.



### ■ To return to Normal Playback

Press ▲/▼/◀/▶ to select a picture and then press [MENU/SET].

## Using the Playback Zoom

### Press [T] on the zoom button.

1× → 2× → 4× → 8× → 16×

- When you press [W] on the zoom button after enlarging the picture, the magnification becomes lower.
- When you change the magnification, the zoom position indication (B) appears for about 2 seconds, and the position of the enlarged section can be moved by pressing ▲/▼/◀/▶.
- The more a picture is enlarged, the more its quality deteriorates.

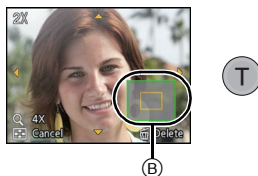

## Playing Back Motion Pictures

This unit was designed to play motion pictures using the AVCHD, MP4 and QuickTime Motion JPEG formats.

Press ◀▶ to select a picture with a motion picture icon (such as [MP4] or [AVCHD]), and then press ▲ to play back.

(A) Motion picture icon

(B) Motion picture recording time

• After playback starts, the elapsed playback time is displayed on the screen.

For example, 8 minutes and 30 seconds is displayed as [8m30s].

• Some information (recording information, etc.) is not displayed for motion pictures recorded in [AVCHD].

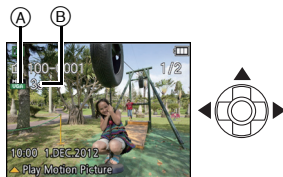

### ■ Operations performed during Motion Picture Playback

The cursor displayed during playback is the same as ▲/▼/◀▶.

▲	Play/Pause	
▼	Stop	
◀	Fast rewind* / Frame-by-frame rewind (while pausing)	
▶	Fast forward* / Frame-by-frame forward (while pausing)	
[W]	Reduce volume level	
[T]	Increase volume level	

\* The fast forward/rewind speed increases if you press ▶/◀ again.

#### Note

- When using a high capacity card, it is possible that fast rewinding may be slower than usual.
- To play back the motion pictures recorded by this unit on a PC, use the “PHOTOfunSTUDIO” software on the CD-ROM (supplied).
- Motion pictures recorded with other camera may not be able to play back on this unit.
- Be careful not to block the speaker of the camera during playback.
- Motion pictures recorded in Miniature Effect Mode play back at approximately 8 times speed.

## Creating Still Pictures from a Motion Picture

You can create a single still picture from a recorded motion picture.

**1 Press ▲ to pause motion picture playback.**

**2 Press [MENU/SET].**

- Confirmation screen is displayed. It is executed when [Yes] is selected. Exit the menu after it is executed.

 **Note**

- The picture is saved with the following recording sizes.

[AVCHD]	Picture size	[MP4]	Picture size
[GFS]/[FSH] [GS]/[SH]	2 M (16:9)	[FHD]/[HD]	2 M (16:9)
		[VGA]	0.3 M (4:3)

- You may not be able to save still pictures from a motion picture taken on other equipment.
- Still pictures created from a motion picture may be coarser than with normal picture quality.

## Deleting Pictures

**Once deleted, pictures cannot be recovered.**

- Pictures on the built-in memory or the card that are being played back will be deleted.
- Pictures that are not in the DCF standard or those that are protected cannot be deleted.

Press [▶].

### To delete a single picture

**Select the picture to be deleted, and then press [🗑️/↩️].**

- Confirmation screen is displayed.  
Picture is deleted by selecting [Yes].

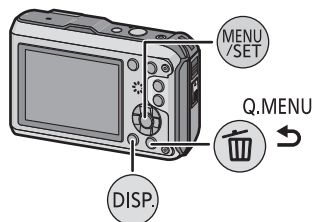

## To delete multiple pictures (up to 100) or all the pictures

**1** Press [🗑️/↵].

**2** Press ▲/▼ to select [Delete Multi] or [Delete All] and then press [MENU/SET].

- [Delete All] → Confirmation screen is displayed. Pictures are deleted by selecting [Yes].
- It is possible to delete all pictures except the ones set as favourite when [All Delete Except Favorite] is selected with the [Delete All] set.



**3** (When [Delete Multi] is selected) Press ▲/▼/◀/▶ to select the picture, and then press [DISP.] to set. (Repeat this step.)

- [📄] appears on the selected pictures. If [DISP.] is pressed again, the setting is cancelled.

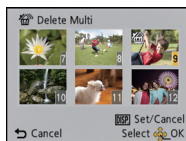

**4** (When [Delete Multi] is selected), Press [MENU/SET].

- Confirmation screen is displayed. Pictures are deleted by selecting [Yes].



### Note

- The picture group taken in [Time Lapse Shot] (pictures with the [📄] icon) will be treated as a single picture. Deleting the picture group will delete all pictures in the group. (P107)
- Do not turn the camera off while deleting. Use a battery with sufficient battery power or the AC adaptor (optional).
- Depending on the number of pictures to be deleted, it may take some time to delete them.

## Setting the Menu

The camera comes with menus that allow you to choose the settings for taking pictures and playing them back just as you like and menus that enable you to have more fun with the camera and use it more easily.

In particular, the [Setup] menu contains some important settings relating to the camera's clock and power. Check the settings of this menu before proceeding to use the camera.

### Setting menu items

Example:

In the [Rec] menu, change [AF Mode] from  ([1-Area]) to  ([Face Detection])

**1** Press [MENU/SET].

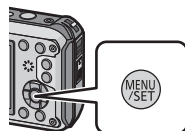

**2** Press /// to select menu and then press [MENU/SET].

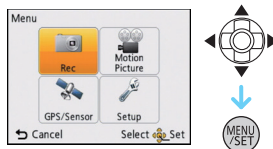

Menu	Description of settings
[Rec] (P91 to 110) (Recording Mode only)	This menu lets you set the Colouring, Sensitivity, Aspect Ratio, Number of pixels and other aspects of the pictures you are recording.
[Motion Picture] (P111 to 113) (Recording Mode only)	This menu lets you set the [Rec Mode], [Rec Quality], and other aspects for motion picture recording.
[Playback] (P139 to 154) (Playback Mode only)	This menu lets you set the Protection, Cropping or Print Settings, etc. of recorded pictures.
[GPS/Sensor] (P114 to 131)	This menu lets you adjust the altimeter and depth meter or display the current location information using the GPS function.
[Setup] (P49 to 60)	This menu lets you perform the clock settings, beep tone settings and other settings which make it easier for you to operate the camera.

### 3 Press ▲/▼ to select the menu item and then press [MENU/SET].

(A) Menu screen page

- It will switch to next page when you reach the bottom. (It will also switch by pressing the zoom button)

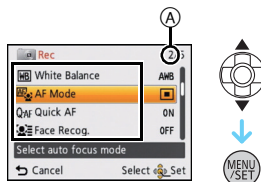

### 4 Press ▲/▼ to select the setting and then press [MENU/SET].

- Depending on the menu item, its setting may not appear or it may be displayed in a different way.



#### ■ Close the menu

Press [🗑️/↩️] several times or press the shutter button halfway.

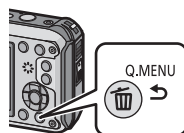

#### Note

- There are functions that cannot be set or used depending on the modes or menu settings being used on the camera due to the specifications.

## Using the Quick Menu

By using the Quick Menu, some of the menu settings can be easily found.

- The features that can be adjusted using Quick Menu are determined by the mode or a display style the camera is in.

**1** Press [Q.MENU] when recording.

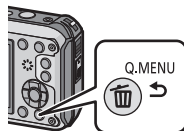

**2** Press ▲/▼/◀/▶ to select the menu item and the setting and then press [MENU/SET] to close the menu.



## About the Setup Menu

[Clock Set], [Economy] and [Auto Review] are important items. Check their settings before using them.

**For details on how to select the [Setup] menu settings, refer to P46.**

 <b>[Precautions]</b>	To maintain waterproof performance, display the things you need to check before use.
--	--

- Refer to P9 for details.

 <b>[Clock Set]</b>	Setting Date/Time.
--	--------------------

- Refer to P27 for details.

 <b>[Auto Clock Set]</b>	The clock is updated automatically using the GPS function.
	<p><b>[ON]:</b> This unit receives the date and time information from the GPS satellites and automatically corrects the time for the current location.</p> <p><b>[OFF]</b></p>

- If [ON] is selected, the settings screen will be displayed. Perform the procedures starting from Step 7 of "Setting Date/Time (Clock Set)" (P27). (first time only)
- When [Auto Clock Set] is set to [ON], [World Time] (P50) is set to [Destination] automatically.
- The date and time corrected with [Auto Clock Set] are not as accurate as the radio clock. If it cannot correct accurately, reset the clock using [Clock Set].

 <b>[World Time]</b>	<p>Set the time in your home area and travel destination. You can display the local times at the travel destinations and record them on the pictures you take.</p>
	<p><b>After selecting [Destination] or [Home], press ◀/▶ to select an area, and press [MENU/SET] to set.</b></p> <ul style="list-style-type: none"> <li>• Set [Home] first thing after purchasing. [Destination] can be set after setting up [Home].</li> </ul> <p><b>✈ [Destination]:</b> Travel destination area</p> <p>(A) Current time of the destination area (B) Time difference from home area</p> <p><b>🏠 [Home]:</b> Your home area</p> <p>(C) Current time (D) Time difference from GMT (Greenwich Mean Time)</p>

(A)



(B)

(C)



(D)

- Press ▲ if you are using Summer Time [☀️]. (The time will move forward by 1 hour.) Press ▲ once more to return to the normal time.
- If you cannot find the travel destination in the areas displayed on the screen, set by the time difference from the home area.
- When the [Auto Clock Set] is set to [ON], you can change daylight saving time setting in [Destination] only.

 <b>[Travel Date]</b>	<p>Departure date and return date of the travel as well as the name of the travel destination can be set.</p> <p>You can display the number of days that have passed when playing back the pictures and stamp it on the recorded pictures with [Text Stamp] (P143).</p>
	<p><b>[Travel Setup]:</b></p> <p><b>[SET]:</b> Departure date and return date are set. Elapsed days (how many days after) of the travel are recorded.</p> <p><b>[OFF]:</b> Elapsed days are not recorded.</p> <ul style="list-style-type: none"> <li>• The travel date is automatically cancelled if the current date is after the return date. If the [Travel Setup] is set to [OFF], [Location] will be also set to [OFF].</li> </ul>
	<p><b>[Location]:</b></p> <p><b>[SET]:</b> Travel destination is recorded at the time of recording.</p> <p><b>[OFF]</b></p> <ul style="list-style-type: none"> <li>• For details on how to enter characters, refer to "Entering Text" on P90.</li> </ul>

- The number of days that have passed since the departure date can be printed out using the "PHOTOfunSTUDIO" bundled software on the CD-ROM (supplied).
- The travel date is calculated using the date in the clock setting and the departure date you set. If you set [World Time] to the travel destination, the travel date is calculated using the date in the clock setting and the travel destination setting.
- The travel date setting is memorised even if the camera is turned off.
- The number of days that have passed since the departure date is not recorded before the departure date.
- [Location] is stored separately from the location name information stored in pictures with the GPS function.
- For motion pictures recorded using [FSH]/[SH] in [AVCHD], [Travel Date] cannot be set.
- [Travel Date] cannot be set in the Intelligent Auto Mode. Setting of other Recording Mode will be reflected.

<b>🔊 [Beep]</b>	This allows you to set the beep and shutter sound.	
	<b>🔊 [Beep Level]:</b> [🔊] ([Low]) [🔊] ([High]) [🔊] ([OFF]) <b>🔊 [Beep Tone]:</b> [🔊1]/[🔊2]/[🔊3]	<b>🔊 [Shutter Vol.]:</b> [🔊] ([Low]) [🔊] ([High]) [🔊] ([OFF]) <b>🔊 [Shutter Tone]:</b> [🔊1]/[🔊2]/[🔊3]

<b>🔊 [Volume]</b>	Adjust the volume of the speaker to any of 7 levels.
-------------------	--

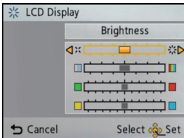

- When you connect the camera to a TV, the volume of the TV speakers does not change. Also, when connected, no sound is output from the camera speakers.

<b>🌟 [LCD Display]</b>	Brightness, colour, or red or blue tint of the LCD monitor is adjusted.	
	<b>[Brightness]:</b> Adjust the brightness. <b>[Contrast · Saturation]:</b> Adjust the contrast or clarity of colours. <b>[Red Tint]:</b> Adjust the red tint. <b>[Blue Tint]:</b> Adjust the blue tint.	
	<ol style="list-style-type: none"> <li><b>1 Select the settings by pressing ▲/▼, and adjust with ◀/▶.</b></li> <li><b>2 Press [MENU/SET] to set.</b></li> </ol>	

- Some subjects may appear differently from actuality on the LCD monitor. However, this does not affect the recorded pictures.

 <b>[LCD Mode]</b>	These menu settings make it easier to see the LCD monitor when you are in bright places.
	<p><b>[A*]</b> ([Auto Power LCD])*: The brightness is adjusted automatically depending on how bright it is around the camera.</p> <p><b>[*]</b> ([Power LCD]): The LCD monitor becomes brighter and easier to see even when taking pictures outdoors.</p> <p><b>[OFF]</b></p> <p>* Can be set only when Recording Mode is set.</p>

- The brightness of the pictures displayed on the LCD monitor is increased so some subjects may appear different from real life on the LCD monitor. However, this does not affect the recorded pictures.
- The LCD monitor automatically returns to normal brightness if no operations are performed for 30 seconds when recording in Power LCD Mode. Press any button to make the LCD monitor bright again.
- When [LCD Mode] is set, the usage time is reduced.

 <b>[Guide Line]</b>	Set the pattern of the guidelines displayed when taking pictures. You can also set whether or not to have the recording information displayed when the guidelines are displayed. (P61)	
	<b>[Rec. Info.]:</b> <b>[ON]/[OFF]</b>	<b>[Pattern]:</b>  / 



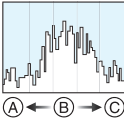



- When you align the subject on the horizontal and vertical guidelines or the cross point of these lines, you can take pictures with well-designed composition by viewing the size, the slope and the balance of the subject.
- The [Pattern] setting is fixed to  in the Intelligent Auto Mode.
- In [Panorama Shot] in Scene Mode, the guideline is not displayed.



 <b>[Histogram]</b>	<p>This allows you to set either to display or not display the histogram.</p>
	<p><b>[ON]/[OFF]</b></p> <p>A Histogram is a graph that displays brightness along the horizontal axis (black to white) and the number of pixels at each brightness level on the vertical axis.</p> <p>It allows you to easily check a picture's exposure.</p> <div style="display: flex; align-items: center;">  </div> <p> <input type="radio"/> (A) dark  <input type="radio"/> (B) optimal  <input type="radio"/> (C) bright         </p>

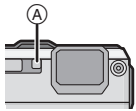

- **When the recorded picture and the histogram do not match each other under the following conditions, the histogram is displayed in orange.**
  - When the Manual Exposure Assistance is other than [ $\pm 0$  EV] during exposure compensation or in the Manual Exposure Mode
  - When the flash is activated
  - When the brightness of the screen is not correctly displayed in dark places
  - When the exposure is not adequately adjusted
- The Histogram is an approximation in Recording Mode.
- The Histogram of a picture may not match in the Recording Mode and the Playback Mode.
- The Histogram displayed in this camera does not match Histograms displayed by picture editing software used in PCs, etc.
- Histograms are not displayed in the following cases.
  - Intelligent Auto Mode
  - Multi Playback
  - Recording motion pictures
  - Playback Zoom
  - Calendar
  - When HDMI micro cable is connected

 <b>[Video Rec Area]</b>	<p>Angle of view for Motion Picture Recording can be checked.</p>
	<p><b>[ON]/[OFF]</b></p>

- Motion picture recording area display is only an approximation.
- Recording area display may disappear when zooming to Tele depending on the picture size setting.
- It will be fixed to [OFF] during the Intelligent Auto Mode.

<b>LED [LED Light]</b>	<p>This will illuminate the subject with a lamp when taking motion pictures in dark surrounding. Also, the LED can also be used as a simple light when necessary.</p>
	<p>[  ]: LED light (A) is turned on continuously while recording motion pictures.</p> <p><b>To use a simple light</b> If you set to [  ], and press and hold down  (  ) on the recording standby screen, the LED light will come on for 60 seconds. The LED light can be conveniently used as a simple light when you wish to illuminate your immediate surroundings in a dark location. To turn off the light at any time, press [  /  ].</p> <p>[  ]</p> <div data-bbox="808 182 953 298" style="float: right;">  </div>

- Maximum illuminating range of the LED light is 50 cm (1.6 feet).
- The life of battery will decrease when the LED light is turned on constantly.
- In locations where the use of light is prohibited, set to [  ].
- It is fixed to [  ] in the following cases.
  - [Underwater]
  - In [Panorama Shot] or [Baby1]/[Baby2] in Scene Mode
  - In 3D Photo Mode
- It is not available in Playback Mode.

ECO [Economy]	You can conserve the battery life by setting these menus. Also, the battery life is conserved by dimming the LCD monitor.
	 <b>[Auto Power Off]:</b> The camera is automatically turned off if the camera has not been used for the time selected on the setting. <b>[2MIN.]/[5MIN.]/[10MIN.]/[OFF]</b>
	 <b>[LCD Power Save]:</b> Brightness of the LCD monitor is lowered. The battery life will be conserved by lowering the image quality of the LCD monitor further during the recording*. * Excluding the Digital Zoom range. <b>[ON]/[OFF]</b>

- [Auto Power Off] is set to [5MIN.] in the Intelligent Auto Mode.
- [Auto Power Off] does not work in the following cases.
  - When using the AC adaptor
  - When connecting to a PC or a printer
  - When recording or playing back motion pictures
  - During a Slide Show
  - [Auto Demo]
  - When using [Time Lapse Shot]
- The effect of the [LCD Power Save] is lower in the Digital Zoom range compared to the Optical Zoom range.
- The effect of the [LCD Power Save] will not affect the image being recorded.
- Setting of [LCD Mode] has priority over the setting of [LCD Power Save] regarding the brightness of the LCD monitor.

 <b>[Auto Review]</b>	Set the length of time that the picture is displayed after taking the still picture.
	<b>[1SEC.]</b> <b>[2SEC.]</b> <b>[HOLD]:</b> The pictures are displayed until one of the buttons is pressed. <b>[OFF]</b>





- [Auto Review] is activated regardless of its setting in the following cases.
  - When using Auto Bracket
  - When using [Burst]
- In Intelligent Auto Mode or [Panorama Shot] in Scene Mode, the Auto Review function is fixed to [2SEC.].
- [Auto Review] does not work in the following cases.
  - When using [Time Lapse Shot]
  - When recording motion pictures.



 <b>[No.Reset]</b>	Reset the file number of the next recording to 0001.
---	--

- The folder number is updated and the file number starts from 0001.
- A folder number between 100 and 999 can be assigned.  
When the folder number reaches 999, the number cannot be reset. We recommend formatting the card (P60) after saving the data on a PC or elsewhere.
- To reset the folder number to 100, format the built-in memory or the card first and then use this function to reset the file number.  
A reset screen for the folder number will then appear. Select [Yes] to reset the folder number.

 <b>[Reset]</b>	The [Rec] or [Setup] menu settings are reset to the initial settings.
--	---

- When the [Rec] menu settings are reset during recording, the operation that resets the lens is also performed at the same time. You will hear the sound of the lens operating but this is normal and not indicative of malfunctioning.
- When the [Rec] menu settings are reset, data registered with [Face Recog.] will be also reset.
- When [Setup] menu settings are reset, the following settings are also reset.
  - The birthday and name settings for [Baby1]/[Baby2] and [Pet] in Scene Mode
  - [GPS/Sensor] menu
  - The settings of [Travel Date] (departure date, return date, location)
  - The [World Time] setting
- The folder number and the clock setting are not changed.

 <b>[USB Mode]</b>	Select the USB communication system after or before connecting the camera to your PC or your printer with the USB connection cable (supplied).
	<p> ([Select on connection]): Select either [PC] or [PictBridge(PTP)] if you connected the camera to a PC or a printer supporting PictBridge.</p> <p> ([PictBridge(PTP)]): Set after or before connecting to a printer supporting PictBridge.</p> <p> ([PC]): Set after or before connecting to a PC.</p>



 <b>[Output]</b>	Set to match the colour television system in each country or the type of TV.
	<p> (<b>[Video Out]</b>):</p> <p><b>[NTSC]:</b> Video output is set to NTSC system.</p> <p><b>[PAL]:</b> Video output is set to PAL system.</p> <ul style="list-style-type: none"> <li>• This will operate when the AV cable (supplied) or HDMI micro cable (optional) is connected.</li> </ul>
	<p> (<b>[TV Aspect]</b>):</p> <p><b>[16:9]:</b> When connecting to a 16:9 screen TV.</p> <p><b>[4:3]:</b> When connecting to a 4:3 screen TV.</p> <ul style="list-style-type: none"> <li>• This will work when the AV cable (supplied) is connected.</li> </ul>

 <b>[VIERA Link]</b>	Setup so this unit can be controlled by the remote control of the VIERA by automatically coupling this unit with the VIERA Link compatible equipment using HDMI micro cable (optional).
	<p><b>[ON]:</b> Remote control operation of the VIERA Link compatible equipment is enabled. (Not all operations are possible) Button operation of the main unit will be limited.</p> <p><b>[OFF]:</b> Operation is performed with the buttons on this unit.</p>

- This will work when the HDMI micro cable (optional) is connected.
- Refer to [P157](#) for details.

 <b>[3D Playback]</b>	Setup the output method for 3D pictures.
	<p><b>[3D]:</b> Set when connecting to a 3D compatible television.</p> <p><b>[2D]:</b> Set when connecting to a television not compatible with 3D. Set this when you would like to view pictures in 2D (conventional image) on a 3D compatible television.</p>

- This will work when the HDMI micro cable (optional) is connected.
- Refer to [P159](#) for the method to play back 3D pictures in 3D.

 <b>[Rotate Disp.]</b>	This mode allows you to display pictures vertically if they were recorded holding the camera vertically.
	<p> ([On]): Rotate pictures on a TV and the LCD display so that they are displayed vertically.</p> <p> ([External Only]): Rotate only the picture on a TV so that it is displayed vertically.</p> <p><b>[OFF]</b></p>

- Refer to [P40](#) for information about how to play back pictures.
- When you play back pictures on a PC, they cannot be displayed in the rotated direction unless the OS or software is compatible with Exif. Exif is a file format for still pictures which allows recording information, etc. to be added. It was established by "JEITA (Japan Electronics and Information Technology Industries Association)".
- It may not be possible to rotate pictures that have been recorded with other equipment.
- The display is not rotated during Multi Playback.



<b>Ver.</b> <b>[Version Disp.]</b>	It is possible to check which version of firmware is on the camera.
------------------------------------	---

 <b>[Format]</b>	The built-in memory or card is formatted. <b>Formatting irretrievably deletes all the data so check the data carefully before formatting.</b>
---	---

- Use a battery with sufficient battery power or the AC adaptor (optional) when formatting. Do not turn the camera off during formatting.
- If a card has been inserted, only the card is formatted. To format the built-in memory, remove the card.
- If the card has been formatted on a PC or other equipment, format it on the camera again.
- It may take longer to format the built-in memory than the card.
- If you cannot format, contact the dealer or your nearest Service Centre.

 <b>[Language]</b>	Set the language displayed on the screen.
---	---

- If you set a different language by mistake, select [] from the menu icons to set the desired language.

<b>DEMO [Demo Mode]</b>	Displays the amount of jitter the camera has detected. ([Stabilizer Demo.]) The camera's features are displayed as Slide Shows. ([Auto Demo])
	<p><b>[Stabilizer Demo.]</b></p> <p> Amount of jitter</p> <p> Amount of jitter after correction</p> <p><b>[Auto Demo]:</b> <b>[ON]</b> <b>[OFF]</b></p>

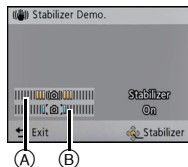

- The Stabiliser function is switched between [On] and [Off] every time [MENU/SET] is pressed during the [Stabilizer Demo.].
- [Stabilizer Demo.] is an approximation.
- [Auto Demo] is not output to the television.

## About the LCD Monitor

Press [DISP.] to change.

**1** LCD monitor

- When the menu screen appears, the [DISP.] button is not activated. During Playback Zoom, while playing back Motion Pictures and during a Slide Show, you can only select (G) or (K).

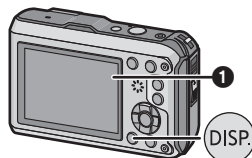

### In Recording Mode

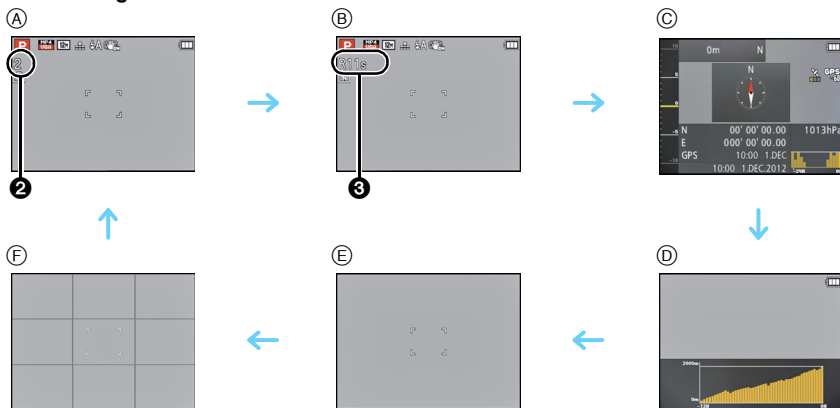

- (A) Normal display\*1
- (B) Normal display\*1
- (C) Environment information\*2
- (D) Altimeter log\*3
- (E) No display
- (F) No display (Recording guide line)\*1

**2** Number of recordable pictures

**3** Available recording time

- \*1 If the [Histogram] in [Setup] menu is set to [ON], Histogram will be displayed.
- \*2 If the [Sensor Settings] in [GPS/Sensor] menu is set to [ON], the environment information measured by the compass, altimeter, and barometer is displayed. Also if the [GPS Setting] is set to [ON], the latitude/longitude is displayed.
- \*3 If the [Logging] of [Altimeter] (selectable when [Sensor Settings] is set to [ON]) in [GPS/Sensor] menu is set to [ON], a graph displaying an altimeter log is displayed.

## In Playback Mode

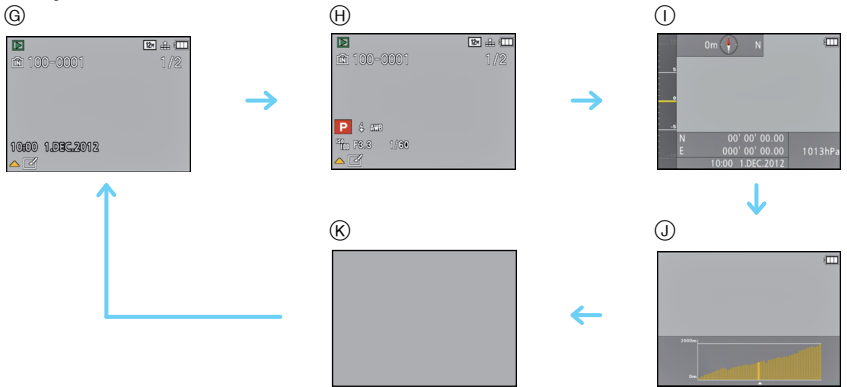

- Ⓒ Normal display
- Ⓗ Display with recording information\*1
- Ⓘ Environment information
- Ⓙ Altimeter log
- Ⓚ No display\*2

\*1 If the [Histogram] in [Setup] menu is set to [ON], Histogram will be displayed.

\*2 Name of the registered person in [Face Recog.] is displayed when [DISP.] is pressed.

Applicable modes:       

## Using the Zoom

### Using the Optical Zoom/Using the Extra Optical Zoom (EZ)/Using the Intelligent Zoom/Using the Digital Zoom

You can zoom in to make people and objects appear closer or zoom out to record landscapes in wide angle.

Setting the number of pixels to 8 M or less will operate the Extra Optical Zoom to take zoomed pictures without affecting quality.

**To make subjects appear further away use (Wide)**

**Press [W] on the zoom button.**

**To make subjects appear closer use (Tele)**

**Press [T] on the zoom button.**

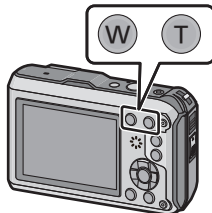

#### ■ Types of zooms

Feature	Optical Zoom	Extra Optical Zoom (EZ)
Maximum magnification	4.6×	9.1×*1
Picture quality	No deterioration	No deterioration
Conditions	None	[Picture Size] with  (P92) is selected.

\*1 This includes the optical zoom magnification. The magnification level differs depending on [Picture Size] setting.

The zoom functions below can also be used to further increase the zoom magnification.

Feature	Intelligent Zoom	Digital Zoom
Maximum magnification	Approx. 2×	4×*2
Picture quality	Zoom in while limiting deterioration	The higher the magnification level, the greater the deterioration.
Conditions	[i.Resolution] (P102) on the [Rec] menu is set to [i.ZOOM].	[Digital Zoom] (P102) on the [Rec] menu is set to [ON].

\*2 This is 2× magnification when [i.Resolution] in [Rec] menu is set to [i.ZOOM].

## ■ Screen display

- (A) Extra Optical Zoom indication
- (B) Optical Zoom range
- (C) Intelligent Zoom range
- (D) Digital Zoom range
- (E) Zoom magnification

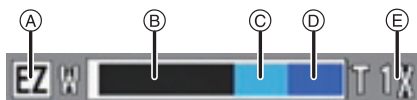

- When using the Zoom function, an estimate of the focus range will appear in conjunction with the zoom display bar. [Example: 0.3 m (0.98 ft.) –∞]

### Note

- The indicated zoom magnification is an approximation.
- “EZ” is an abbreviation of “Extra Optical Zoom”. It is possible to take more magnified pictures with the optical zoom.
- When using the Digital Zoom, we recommend using a tripod and the Self-timer (P69) for taking pictures.
- For details about using the zoom while recording motion pictures, refer to P39.
- The Extra Optical Zoom cannot be used in the following cases.
  - In [Motion Deblur] in Intelligent Auto Mode
  - In Macro Zoom Mode
  - In [Handheld Night Shot] or [High Sens.] in Scene Mode
  - When [Burst] in the [Rec] menu is set to [📷] or [📷]
  - When recording motion pictures
- The Intelligent Zoom cannot be used in the following cases.
  - In [Motion Deblur] in Intelligent Auto Mode
  - In Macro Zoom Mode
  - In [Handheld Night Shot] or [High Sens.] in Scene Mode
  - When [Burst] in the [Rec] menu is set to [📷] or [📷]
- [Digital Zoom] cannot be used in the following cases.
  - In Intelligent Auto Mode
  - In Miniature Effect Mode
  - In [Handheld Night Shot] or [High Sens.] in Scene Mode
  - When [Burst] in the [Rec] menu is set to [📷] or [📷]

Applicable modes: SCN 3D

## Taking Pictures Using the Built-in Flash

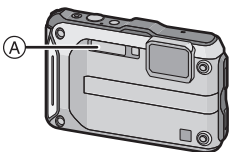

### A Photo flash

Do not cover the flash with your fingers or other objects.

### Switching to the appropriate flash setting

Set the flash to match the recording.

**1** Press **▶** [].

**2** Press **▲/▼** to select the item and then press **[MENU/SET]**.

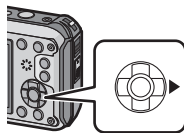

Item	Description of settings
[A] ([Auto]) [iA] ([iAuto])*1	The flash is automatically activated when the recording conditions make it necessary.
[A⊙] ([Auto/Red-Eye])*2	The flash is automatically activated when the recording conditions make it necessary. It is activated once before the actual recording to reduce the red-eye phenomenon (eyes of the subject appearing red in the picture) and then activated again for the actual recording. • <b>Use this when you take pictures of people in low lighting conditions.</b>
[↓] ([Forced Flash On])	The flash is activated every time regardless of the recording conditions. • <b>Use this when your subject is back-lit or under fluorescent light.</b>
[⊙] ([Slow Sync./Red-Eye])*2	If you take a picture with a dark background landscape, this feature will slow the shutter speed when the flash is activated so that the dark background landscape will become bright. Simultaneously it reduces the red-eye phenomenon. • <b>Use this when you take pictures of people in front of a dark background.</b>
[⊘] ([Forced Flash Off])	The flash is not activated in any recording conditions. • <b>Use this when you take pictures in places where the use of the flash is not permitted.</b>

\*1 This can be set only when Intelligent Auto Mode is set. The icon changes depending on the type of subject and brightness. (P37)

\*2 **The flash is activated twice. The subject should not move until the second flash is activated. Interval until the second flash depends on the brightness of the subject.**  
[Red-Eye Removal] (P109) on the [Rec] menu is set to [ON], [] appears on the flash icon.

## ■ Available flash settings by Recording Mode

The available flash settings depend on the Recording Mode.

(○: Available, —: Not available, ●: Scene Mode initial setting)

	⚡A	⚡AⓄ	⚡	⚡SⓄ	Ⓞ
iA	○*	—	—	—	○
P	○	○	○	○	○
M	○	○	○	—	○
	○	—	○	—	○
	○	●	○	—	○
	—	—	—	—	●
	—	—	—	●	○
	○	—	○	—	●

\* [iA] is displayed.

- The flash setting may change if the Recording Mode is changed. Set the flash setting again if necessary.
- The flash setting is memorised even if the camera is turned off. However, the Scene Mode flash setting is reset to the initial setting when the Scene Mode is changed.
- Flash will not be activated when recording motion picture.

## ■ The available flash range

- The available flash range is an approximation.

	Wide	Tele
[AUTO] in [Sensitivity]	30 cm (0.98 feet) to 5.6 m (18 feet)	30 cm (0.98 feet) to 3.1 m (10 feet)

## ■ Shutter speed for each flash setting

Flash setting	Shutter speed (Sec.)	Flash setting	Shutter speed (Sec.)
⚡A	1/60 to 1/1300*1	⚡SⓄ	1 to 1/1300*1 1 or 1/4 to 1/1300*2
⚡AⓄ			
⚡		Ⓞ	

\*1 It may vary depending on the [Min. Shtr Speed] setting.

\*2 When [Min. Shtr Speed] is set to [AUTO].

- \*2: The shutter speed becomes a maximum of 1 second in the following cases.
  - When the Optical Image Stabiliser is set to [OFF].
  - When the camera has determined that there is very little jitter when the Optical Image Stabiliser is set to [ON].
- In Intelligent Auto Mode, shutter speed changes depending on the identified scene.
- The shutter speed for Manual Exposure Mode, [Sports], [Snow], [Beach & Snorkeling], [Underwater] and Scene Modes will be different from above table.

 **Note**

- If you bring the flash too close to an object, the object may be distorted or discoloured by the heat or lighting from the flash.
- Recording a subject from too close, or without sufficient flash will not provide the appropriate level of exposure, and may result in a picture that is too white or dark.
- When the flash is being charged, the flash icon blinks red, and you cannot take a picture even when you press the shutter button fully.
- If recording a subject without sufficient flash, the White Balance may not be properly adjusted.
- The effects of the flash may not be adequately achieved under the following conditions.
  - When [Burst] in the [Rec] menu is set to 
  - When the shutter speed is too fast
- It may take time to charge the Flash if you repeat taking a picture. Take a picture after the access indication disappears.
- The Red-Eye Reduction effect differs between people. Also, if the subject is far away from the camera or was not looking at the first flash, the effect may not be as evident.

Applicable modes:  **P** **M**      **SCN** **3D**



## Taking Close-up Pictures ([AF Macro]/[Macro Zoom])

This mode allows you to take close-up pictures of a subject, e.g. when taking pictures of flowers.

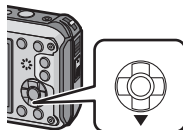



**1** Press .



**2** Press  to select the item and then press **[MENU/SET]**.

Item	Description of settings
<b>[AF </b> ([AF Macro])	You can take pictures of a subject as close as 5 cm (0.16 feet) from the lens by pressing the zoom button upmost to Wide (1×).
<b>[</b> ([Macro Zoom])	Use this setting to get close to the subject and then further enlarge when taking the picture. You can take a picture with the Digital Zoom up to 3× while maintaining the distance to the subject for the extreme Wide position [5 cm (0.16 feet)]. • The image quality is poorer than during normal recording. • Zoom range will be displayed in blue. (Digital zoom range)
<b>[OFF]</b>	—

### Note

- We recommend using a tripod and the Self-timer.
- We recommend setting the flash to  when you take pictures at close range.
- If the distance between the camera and the subject is beyond the focus range of the camera, the picture may not be properly focused even if the focus indication lights up.
- When a subject is close to the camera, the effective focus range is significantly narrowed. Therefore, if the distance between the camera and the subject is changed after focusing on the subject, it may become difficult to focus on it again.
- Macro Mode gives priority to a subject close to the camera. Therefore, if the distance between the camera and the subject is far, it takes longer to focus on it.
- When you take pictures at close range, the resolution of the periphery of the picture may decrease slightly. This is not a malfunction.
- [Macro Zoom] cannot be used in the following cases.
  - In Miniature Effect Mode
  - In 3D Photo Mode
  - When  in [AF Mode] is set
  - When [Burst] is set to  or 



Applicable modes:        

## Taking Pictures with the Self-timer

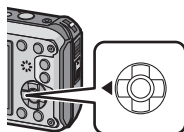
**1** Press ◀ [].



**2** Press ▲/▼ to select the item and then press [MENU/SET].

Item	Description of settings
[  ] ([10 sec.])	Picture is taken 10 seconds after shutter is pressed.
[  ] ([2 sec.])	Picture is taken 2 seconds after shutter is pressed. • When using a tripod etc., this setting is a convenient way to avoid the jitter caused by pressing the shutter button.
[OFF]	—

**3** Press the shutter button halfway to focus and then press it fully to take the picture.

- The Self-timer indicator (A) blinks and the shutter is activated after 10 seconds (or 2 seconds).

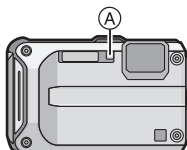
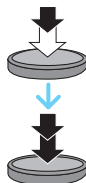

### Note

- When you press the shutter button once fully, the subject is automatically focused just before recording. In dark places, the Self-timer indicator will blink and then may turn on brightly operating as an AF Assist Lamp to allow the camera to focus on the subject.
- We recommend using a tripod when recording with the Self-timer.
- The self-timer cannot be set in the following cases.
  - When using [Time Lapse Shot]
  - When recording motion pictures.

Applicable modes:        

## Compensating the Exposure

Use this function when you cannot achieve appropriate exposure due to the difference in brightness between the subject and the background.

### Underexposed



Compensate the exposure towards positive.

### Properly exposed



### Overexposed



Compensate the exposure towards negative.

**1** Press   until [Exposure] appears.

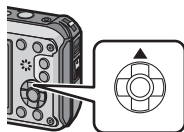

**2** Press   to compensate the exposure and then press [MENU/SET].

- The exposure compensation value appears on the screen.
- Select [0 EV] to return to the original exposure.

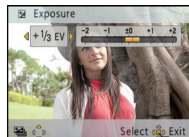

### Note

- EV is an abbreviation of [Exposure Value], a unit indicating the amount of exposure. The EV changes with the aperture value or the shutter speed.
- The set exposure value is memorised even if the camera is turned off.
- The compensation range of the exposure will be limited depending on the brightness of the subject.



Recording Mode: **M**

## Taking picture by setting the exposure manually (Manual Exposure Mode)

Determine the exposure by manually setting the aperture value and the shutter speed. The Manual Exposure Assistance appears on the lower portion of the screen to indicate the exposure.

- 1** Press **[MODE]**.
- 2** Press **▲/▼/◀/▶** to select **[Manual Exposure]**, and then press **[MENU/SET]**.
- 3** Press **▲**.
  - Press **[DISP.]** to select between the aperture value setting and the shutter speed setting.
- 4** Press **◀/▶** to adjust, and then press **[MENU/SET]**.
  - (A) Aperture Value
  - (B) Shutter Speed
  - (C) Manual Exposure Assistance



Available Aperture Value (Wide)	Available Shutter Speed (Sec) (Per 1/3 EV)
F3.3	60 to 1/1300
F10	

• Depending on the zoom magnification, available aperture values change.





### Manual Exposure Assistance

	The exposure is adequate.
	Set to faster shutter speed or larger aperture value.
	Set to slower shutter speed or smaller aperture value.





• The Manual Exposure Assistance is an approximation. We recommend checking the pictures on the playback screen.

### Note

- The brightness of the LCD monitor and the recorded pictures may differ. Check the pictures on the playback screen.
- The aperture value and the shutter speed displayed on the screen turn red when the exposure is not adequate.
- Display of the shutter speed will count down when the shutter speed is set slow and the shutter button is pressed all the way.
- We recommend using a tripod when the shutter speed is slow.
- The **[Sensitivity]** is automatically set to **[100]** when you change the Recording Mode to Manual Exposure Mode while the **[Sensitivity]** is set to **[AUTO]** or **[ISO]**.

Recording Mode:    

## Take the Outdoors Scene Expressively

By setting the Recording Mode to [], [], [] or [] pictures can be taken more effectively matching the conditions such as sports, snow, beach & snorkeling.

### Note

- Tone of the colour of the image may change when picture is taken with unmatched usage.
- The following cannot be set as the camera adjusts automatically.  
– [Sensitivity]/[i.Exposure]/[Min. Shtr Speed]/[i.Resolution]/[Color Mode]/[Red-Eye Removal]

### [Sports]

Set here when you want to take pictures of sports scenes or other fast-moving events.

**1** Press [MODE].

**2** Press /// to select [Sports], and then press [MENU/SET].

### Note

- Shutter speed may slow down up to 1 second.
- This mode is suitable for taking pictures of subjects at distances of 5 m (16 feet) or more.

### [Snow]

This allows you to take pictures that show the snow as white as possible at a ski resort or a snow-covered mountain.

**1** Press [MODE].

**2** Press /// to select [Snow], and then press [MENU/SET].

### Note

- To prevent water leakage, make sure that there are no foreign objects, such as sand, hair, dust, etc., clamped and close the side door all the way until it clicks. Also, read "(Important) About the Waterproof/Dustproof and Anti-shock Performance of the Camera" (P8) before using the camera.

## [Beach & Snorkeling]

This is optimal for taking pictures underwater and at the beach. Depth meter will automatically operate. It can be a rough indication of how deep you have gone underwater.

- 1** Press [MODE].
- 2** Press ▲/▼/◀/▶ to select [Beach & Snorkeling], and then press [MENU/SET].

### ■ About the [Depth indicator]

Make sure to perform [Depth indicator] in [GPS/Sensor] menu to set the depth meter before you dive underwater.

- 1** Press [MENU/SET].
- 2** Press ▲/▼/◀/▶ to select [GPS/Sensor] menu, and then press [MENU/SET].
- 3** Press ▲/▼ to select [Depth indicator], and then press [MENU/SET].
  - Confirmation screen is displayed. Depth meter will be set to 0 m (0 feet) when [Yes] is selected. Exit the menu once completed.

### ■ About the screen display underwater

When [DISP.] is pressed several times, the environment information screen for the depthmeter, etc. is displayed.

(A) Depth meter

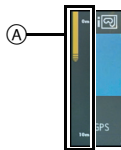

- Depth meter will display the depth to 12 m (40 feet) in 3 levels.

<b>When the third level is flashing</b>	You are approaching a depth of 12 m (40 feet), which is the diving limit of this unit. Please be aware.
<b>Entire depth meter is flashing</b>	There is risk that depth has exceeded 12 m (40 feet).

- Camera will automatically set to the optimal picture quality for underwater from the depth information. Icons showing the picture quality will switch in such a case.

	It is adjusted to optimal picture quality for underwater up to a depth of 3 m (10 feet) when  is displayed.
	It is adjusted to optimal picture quality for underwater for a depth of 3 m (10 feet) to 12 m (40 feet) when  is displayed.

### ■ About the white balance

You can adjust the hue to your preferred setting using [WB Adjust.] (P97).

 **Note**

- Measured depth may not be accurate when pressure is applied to front or rear of this unit by pressing with your hands, etc. In such a case, it is recommended to perform [Depth indicator] again when you get back to the surface.
- The display may differ significantly depending on the weather conditions (atmospheric pressure, air temperature), or seawater temperature.
- For more accurate depth measurements, we recommend that you perform [Depth indicator] before you dive underwater.
- When the unit is wet immediately after coming out of the water, etc., it may not be able to measure atmospheric pressure accurately. For details, read "About the measured altitude and atmospheric pressure" (P128).
- To prevent water leakage, make sure that there are no foreign objects, such as sand, hair, dust, etc., clamped and close the side door all the way until it clicks. Also, read "(Important) About the Waterproof/Dustproof and Anti-shock Performance of the Camera" (P8) before using the camera.
- Dip the camera in fresh water in a shallow container for 10 minutes or less after using it, then wipe the water off with a soft, dry cloth. (P11)

## [Underwater]

This is optimal for taking pictures underwater deeper than 12 m (40 feet) by the use of the marine case (DMW-MCFT3: optional).

\* This camera has a waterproof/dustproof function equivalent to "IP68". It is possible to take pictures in 12 m (40 feet) depth for 60 minutes.

**1** Press [MODE].

**2** Press ▲/▼/◀/▶ to select [Underwater], and then press [MENU/SET].

### ■ Fixing the focus underwater (AF Lock)

You can fix the focus before taking a picture with AF lock. This is useful if you want to take pictures of a fast moving subject, etc.

**1** Aim the AF area at the subject.

**2** Press ◀ to fix the focus.

- The AF lock icon appears when the subject is focused.
- Press ◀ again to cancel AF lock.
- When you press the zoom button, the AF lock is cancelled. In this case, focus on the subject and fix the focus again.
- You cannot set to AF lock when [AF Mode] is set to [AF:OFF].

### ■ About the white balance

You can adjust the hue to your preferred setting using [WB Adjust.] (P97).

#### Note

- To prevent water leakage, make sure that there are no foreign objects, such as sand, hair, dust, etc., clamped and close the side door all the way until it clicks. Also, read "(Important) About the Waterproof/Dustproof and Anti-shock Performance of the Camera" (P8) before using the camera.
- Dip the camera in fresh water in a shallow container for 10 minutes or less after using it, then wipe the water off with a soft, dry cloth. (P11)
- **Positioning is not possible underwater, because the GPS signals cannot reach the camera.**
- When there is a significant amount of matter floating in the water, set the flash to [⊕].

Recording Mode: 

## Record pictures that look like dioramas (Miniature Effect Mode)

By creating areas that are blurred and areas that are not, the picture will look like that of a miniature model. Motion pictures can also be recorded with diorama effects that appear to be played back in fast forward.

**1** Press [MODE].

**2** Press ▲/▼/◀/▶ to select [Miniature Effect], and then press [MENU/SET].

### Note

- Display of the recording screen will be delayed more than usual and the screen will look as if frames are dropping.
- No sound is recorded in motion pictures.
- Approximately 1/8 of the time period is recorded. (If you record for 8 minutes, the resulting motion picture recording will be approximately 1 minute long.)  
The displayed available recording time is approximately 8 times. When switching to Recording Mode, please check the available recording time.
- When taking pictures of a large size, the screen may turn black after taking the picture because of signal processing. This is not a malfunction.

Recording Mode: SCN

## Taking Pictures that Match the Scene Being Recorded (Scene Mode)

When you select a Scene Mode to match the subject and recording situation, the camera sets the optimal exposure and hue to obtain the desired picture.

- 1 Press [MODE].
- 2 Press ▲/▼/◀/▶ to select [Scene Mode], and then press [MENU/SET].
- 3 Press ▲/▼/◀/▶ to select the Scene Mode and then press [MENU/SET].

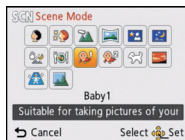

### Note

- To change the Scene Mode, press [MENU/SET], select [Scene Mode] using ▲/▼/◀/▶, and then press [MENU/SET].
- The following cannot be set in Scene Mode as the camera adjusts automatically.
  - [Sensitivity]/[i.Exposure]/[Min. Shtr Speed]/[i.Resolution]/[Color Mode]

## [Portrait]

When taking pictures of people outdoors during the day, this mode allows you to improve the appearance of the persons and make their skin tones look healthier.

### ■ Technique for Portrait Mode

To make this mode more effective:

- ① Press and hold down the zoom button as far as possible to Tele.
- ② Move close to the subject to make this mode more effective.

## [Soft Skin]

When taking pictures of people outdoors during the day, this mode enables the texture of their skin to appear even softer than with [Portrait]. (It is effective when taking pictures of people from the chest up.)

### ■ Technique for Soft Skin Mode

To make this mode more effective:

- ① Press and hold down the zoom button as far as possible to Tele.
- ② Move close to the subject to make this mode more effective.



#### Note

- If a part of the background etc. is a colour close to skin colour, this part is also smoothed.
- This mode may not be effective when there is insufficient brightness.

## [Scenery]

This allows you to take pictures of a wide landscape.

## [Panorama Shot]

Pictures are recorded continuously while moving the camera horizontally or vertically, and are combined to make a single panorama picture.

- 1 Press **▲/▼** to select the recording direction and then press **[MENU/SET]**.

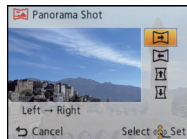

- 2 After confirming the recording direction, press **[MENU/SET]**.

- A horizontal/vertical guide is displayed.

- 3 Press the shutter button halfway to focus.

- 4 Press the shutter button fully and record a picture while moving the camera in a small circle in the direction selected in Step 1.

### ■ Technique for Panorama Shot Mode

Recording from left to right

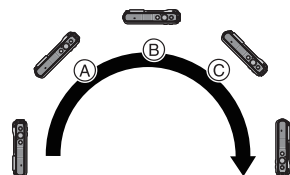

Move the camera in a single swirling motion of about 8 seconds.

- Move the camera at a constant speed.  
Pictures may not be able to be recorded properly if the camera is moved too fast or slow.

- Ⓐ 1 second
- Ⓑ 2 seconds
- Ⓒ 3 seconds

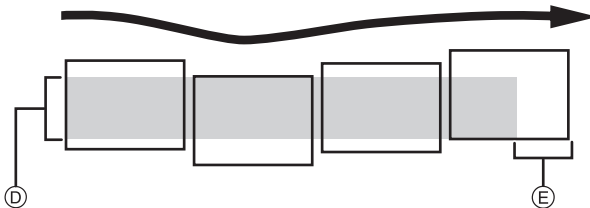

- Ⓓ Move the camera in the recording direction without shaking it. If the camera shakes too much, pictures may not be able to be recorded, or the recorded panorama picture may become narrower (smaller).
- Ⓔ Move the camera towards the edge of the range you wish to record. (The edge of the range will not be recorded in the last frame)

- 5 Press the shutter button once again to end the still picture recording.

- Recording can also be ended by keeping the camera still while recording.

### Note

- The zoom position is fixed to Wide.
- The focus, white balance, and exposure are fixed at the optimum values for the first picture. As a result, if the focus or brightness changes substantially during recording, the entire panorama picture may not be recorded at the suitable focus or brightness.
- When multiple pictures are combined to create a single panorama picture, the subject may appear distorted or the connection points may be noticeable in some cases.
- The number of recording pixels in the horizontal and vertical directions of the panorama picture varies depending on the recording direction and the number of combined pictures. The maximum number of pixels is shown below.

Recording direction	Horizontal Resolution	Vertical Resolution
Horizontal	8000 pixels	1080 pixels
Vertical	1440 pixels	8000 pixels

- A panorama picture may not be able to be created, or the pictures may not be combined properly when recording the following subjects or under the recording conditions below.
  - Subjects with a single, uniform colour or repetitive pattern (such as the sky or a beach)
  - Moving subjects (person, pet, car, waves, flowers blowing in the breeze, etc.)
  - Subjects where the colour or patterns change in a short time (such as an image appearing on a display)
  - Dark places
  - Locations with flickering light sources such as fluorescent lights or candles

### About playback

Playback zoom can be performed even for pictures that were recorded using [Panorama Shot].

If ▲ is pressed during playback, the screen will automatically scroll in the same direction during recording.

The cursor displayed during playback is the same as ▲/▼/◀/▶.

▲	Start/Pause*	
▼	Stop	

- \* You can perform frame-by-frame forward/rewind by pressing ▶/◀ during a pause.

## [Night Portrait]

This allows you to take pictures of a person and the background with near real-life brightness.

### ■ Technique for Night Portrait Mode

- Use the flash. (You can set to [⚡S⊙].)
- Ask the subject not to move while taking a picture.

#### Note

- We recommend using a tripod and the Self-timer for taking pictures.
- Shutter speed may slow down for up to 8 seconds.
- The shutter may remain closed (max. about 8 sec.) after taking the picture because of signal processing. This is not a malfunction.
- Noise may become visible when you take pictures in dark places.

## [Night Scenery]

This allows you to take vivid pictures of the nightscape.

#### Note

- We recommend using a tripod and the self-timer for taking pictures.
- Shutter speed may slow down for up to 8 seconds.
- The shutter may remain closed (max. about 8 sec.) after taking the picture because of signal processing. This is not a malfunction.
- Noise may become visible when you take pictures in dark places.

## [Handheld Night Shot]

This mode allows you to record multiple pictures of night scenes at high speed, which are all combined to make a single picture. It will reduce the jitter and noise from the picture even when recording with the camera in your hand.

### ■ Picture size and aspect ratio

Select the picture size of 3M (4:3), 2.5M (3:2), 2M (16:9) or 2.5M (1:1).

#### Note

- Do not move the camera while recording pictures continuously.
- Noise may become visible when you take pictures in dark places or take pictures of moving subjects.

**[Food]**

This mode allows you to take pictures of food with a natural hue without being affected by the ambient light in restaurants etc.

**[Baby1]/[Baby2]**

This takes pictures of a baby with a healthy complexion. When you use the flash, the light from it is weaker than usual.

It is possible to set different birthdays and names for [Baby1] and [Baby2]. You can select to have these appear at the time of playback, or have them stamped on the recorded image using [Text Stamp] (P143).

**■ Birthday/Name setting**

- 1** Press **▲/▼** to select **[Age]** or **[Name]** and then press **[MENU/SET]**.
- 2** Press **▲/▼** to select **[SET]** and then press **[MENU/SET]**.
- 3** Enter the birthday or name.

Birthday: ◀/▶: Select the items (year/month/day)

▲/▼: Setting

[MENU/SET]: Set

Name: For details on how to enter characters, refer to "Entering Text" on P90.

- When the birthday or name is set, [Age] or [Name] is automatically set to [ON].
- If [ON] is selected when the birthday or name has not been registered, the setting screen appears automatically.

- 4** Press **▼** to select **[Exit]** and then press **[MENU/SET]** to finish.

**■ To cancel [Age] and [Name]**

Select the **[OFF]** setting in step 2.

**Note**

- The age and name can be printed out using the "PHOTOfunSTUDIO" bundled software on the CD-ROM (supplied).
- If [Age] or [Name] is set to [OFF] even when the birthday or name has been set, the age or name will not be displayed.
- Shutter speed may slow down for up to 1 second.

**[Pet]**

Select this when you want to take pictures of a pet such as a dog or a cat. You can set your pet's birthday and name.

For information about [Age] or [Name], refer to [Baby1]/[Baby2] on [P83](#).

**[Sunset]**

Select this when you want to take pictures of sunset view. This allows you to take vivid pictures of the red colour of the sun.

**[High Sens.]**

This mode minimises the jitter of the subjects, and enables you to take pictures of these subjects in dimly lit rooms.

**■ Picture size and aspect ratio**

Select the picture size of 3M (4:3), 2.5M (3:2), 2M (16:9) or 2.5M (1:1).

**[Glass Through]**

This mode is ideal for taking pictures of scenery and other landscapes through clear glass, such as in vehicles or buildings.

**Note**

- The camera may focus on the glass if it is dirty or has dust on it.
- The pictures taken may not look natural if the glass is coloured. When this happens, change the white balance settings. ([P95](#))

Recording Mode: **3D**

## Taking 3D pictures (3D Photo Mode)

Pictures are recorded continuously while moving the camera horizontally, two pictures selected automatically are combined to make a single 3D picture.

To view 3D pictures, a television that supports 3D is required. (This unit will play back in 2D)

Refer to [P159](#) for details about the playback method.

- 1** Press **[MODE]**.
- 2** Press **▲/▼/◀/▶** to select **[3D Photo Mode]**, and then press **[MENU/SET]**.

- Description of recording method is displayed. To exit, press **[MENU/SET]**.

- 3** Start the recording and then slide the camera horizontally straight from left to right.

- A guide is displayed while recording.
- Move the camera approximately 10 cm (0.33 feet) within approximately 4 seconds using the guide.

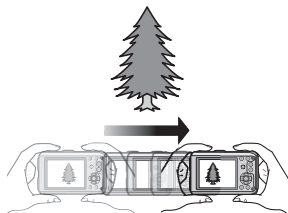

### ■ Technique for taking 3D pictures

- Take a picture of a subject that is not moving
- Take a picture in a well-lit place, such as outdoors, etc.
- Fix the focus and exposure by pressing the shutter button halfway, then press the shutter button fully and move the camera
- When you start recording with the subject slightly to the right of the centre, the subject will be close to the centre in the final picture

### ● Note

- **You cannot record 3D pictures in vertical orientation.**
- The 3D pictures are saved in MPO format (3D).
- Zoom position is fixed to Wide.
- The picture size is fixed to 2M (16:9).
- The ISO sensitivity is automatically adjusted. However, the ISO sensitivity is increased to make the shutter speed become high-speed.
- Motion pictures cannot be recorded during 3D Photo Mode.
- Recording may not be possible depending on the recording conditions for the following cases. You may not get a 3D effect or the picture may be warped even if it was possible to record.
  - When the subject is too dark/bright
  - When the brightness of the subject changes
  - When the subject is moving
  - Not enough contrast

Applicable modes:         

## Taking a Picture with Face Recognition Function

Face Recognition is a function which finds a face resembling a registered face and prioritises focus and exposure automatically. Even if the person is located towards the back or on the end of a line in a group photo, the camera can still take a clear picture.

**[Face Recog.] is initially set to [OFF] on the camera.**

**[Face Recog.] will turn [ON] automatically when the face image is registered.**

- The following functions will also work with the Face Recognition function.

### In Recording Mode

- Display of corresponding name when camera detects a registered face\* (if name has been set for the registered face)

### In Playback Mode

- Display of name and age (if information has been registered)
- Selective playback of pictures chosen from pictures registered with Face Recognition ([Category Selection] in [Filtering Play]).

- \* Names of up to 3 people are displayed. Precedence for the names displayed when taking pictures is determined according to the order of registration.



### Note

- During the Burst Mode, [Face Recog.] picture information can be attached to only the first picture.
- [Face Recog.] does not guarantee secure recognition of a person.
- Face Recognition may take more time to select and recognise distinctive facial features than regular face detection.
- Even when Face Recognition information has been registered, pictures taken with [Name] set to [OFF] will not be categorised by Face Recognition in [Category Selection] ([Filtering Play]).
- **Even when Face Recognition information is changed (P89), Face Recognition information for the pictures already taken will not be changed.**  
For instance, if the name is changed, pictures recorded before the change will not be categorised by Face Recognition in [Category Selection] ([Filtering Play])
- To change the name information of the pictures taken, perform the [REPLACE] in [Face Rec Edit] (P153).
- [Face Recog.] cannot be used in the following cases.
  - Recording Modes which do not allow setting to  of [AF Mode]
  - When recording motion pictures

## Face Settings

You can register information such as names and birthdays for face images of up to 6 people.

Registration can be facilitated by taking multiple face images of each person. (up to 3 pictures/registration)

### ■ Point of recording when registering the face images

- Face front with eyes open and mouth closed, making sure the outline of the face, the eyes, or the eyebrows are not covered with the hair when registering.
- Make sure there is no extreme shading on the face when registering. (Flash will not flash during registration.)

(Good example for registering)



### ■ When it is not recognising during recording

- Register the face of same person indoors and outdoors, or with different expressions or angles. (P88)
- Additionally register at the location of recording.
- When a person who is registered is not recognised, correct by re-registering.
- Face Recognition may not be possible or may not recognise faces correctly even for registered faces, depending on the facial expression and environment.

**1** Select [Face Recog.] on the [Rec] menu and then press [MENU/SET].  
(P46)

**2** Press ▲/▼ to select [MEMORY] and then press [MENU/SET].

**3** Press ▲/▼/◀/▶ to select the Face Recognition frame that is not registered, and then press [MENU/SET].

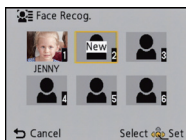

**4** Take the picture adjusting the face with the guide.

- Confirmation screen is displayed. It is executed when [Yes] is selected.
- The faces of subjects other than people (pets, etc.) cannot be registered.
- When [DISP.] is pressed, an explanation appears for taking face images.

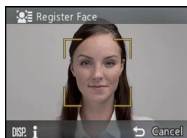

## 5

**Select item to edit with ▲/▼, and then press [MENU/SET].**

- You can register up to 3 face images.

Item	Description of settings
[Name]	<p>It is possible to register names.</p> <ol style="list-style-type: none"> <li><b>1 Press ▼ to select [SET] and then press [MENU/SET].</b></li> <li><b>2 Enter the name.</b> <ul style="list-style-type: none"> <li>• For details on how to enter characters, refer to “Entering Text” section on P90.</li> </ul> </li> </ol>
[Age]	<p>It is possible to register the birthday.</p> <ol style="list-style-type: none"> <li><b>1 Press ▼ to select [SET] and then press [MENU/SET].</b></li> <li><b>2 Press ◀/▶ to select the items (Year/Month/Day), and then press ▲/▼ to set and then press [MENU/SET].</b></li> </ol>
[Focus Icon]	<p>Change the displayed focus icon when the subject is focused.</p> <p><b>Press ▲/▼ to select the focus icon, and then press [MENU/SET].</b></p>
[Add Images]	<p>To add additional face images. <b>(Add Images)</b></p> <ol style="list-style-type: none"> <li><b>1 Select the unregistered Face Recognition frame, and then press [MENU/SET].</b></li> <li><b>2 Perform steps 4 in “Face Settings”.</b></li> </ol>
	<p>To delete one of the face images. <b>(Delete)</b></p> <p><b>Press ◀/▶ to select the face image to delete, and then press [MENU/SET].</b></p> <ul style="list-style-type: none"> <li>• If there is only one image registered, it cannot be deleted.</li> </ul>

- Exit the menu after it is set.

### Change or delete the information for a registered person

You can modify the pictures or information of an already registered person. You can also delete the information of the registered person.

- 1** Select [Face Recog.] from the [Rec] menu, and then press [MENU/SET]. (P46)
- 2** Press ▼ to select [MEMORY] and press [MENU/SET].
- 3** Press ▲/▼/◀/▶ to select the face image to edit or delete and then press [MENU/SET].
- 4** Press ▲/▼ to select the item and then press [MENU/SET].

Item	Description of settings
[Info Edit]	Changing the information of an already registered person. <b>Perform step 5 in “Face Settings”.</b>
[Priority]	The focus and exposure are preferentially adjusted for higher-priority faces. <b>Press ▲/▼/◀/▶ to select the priority and then press [MENU/SET].</b>
[Delete]	Deleting information of a registered person.

- Exit the menu after it is set.

## Entering Text

It is possible to enter babies' and pets' names and the locations when recording. (Only alphabetical characters and symbols can be entered.)

### 1 Display the entry screen.

- You can display the entry screen via the following operations.
  - [Name] of [Baby1]/[Baby2] or [Pet] in Scene Mode
  - [Name] in [Face Recog.]
  - [My Landmark]
  - [Location] in [Travel Date]
  - [Title Edit]
  - [Place-Name Edit]

### 2 Press ▲/▼/◀/▶ to select text and then press [MENU/SET] to register.

- Move the cursor to [<sup>A</sup>,<sub>a</sub>] and then press [MENU/SET] to switch text between [A] (capitals), [a] (lower case), [1] (numbers) and [&] (special characters).
- To continuously enter the same character, move the cursor by pressing [T] on the zoom button.
- The following operations can be performed by moving the cursor to the item and pressing [MENU/SET]:
  - [ ]: Enter a blank
  - [Delete]: Delete a character
  - [◀]: Move the entry position cursor to the left
  - [▶]: Move the entry position cursor to the right
- The following characters and numbers can be entered.
  - A maximum of 30 characters can be entered (Maximum of 9 characters when setting names in [Face Recog.]).
    - \* A maximum of 15 characters can be entered for [ \ ], [ [ ], [ ] ], [ • ] and [ - ] (Maximum of 6 characters when setting names in [Face Recog.]).



### 3 Press ▲/▼/◀/▶ to move the cursor to [Set] and then press [MENU/SET] to end text input.

#### Note

- Text can be scrolled if all of the entered text does not fit on the screen.
- It is displayed in order of location name information, title, location, [Name] ([Baby1]/[Baby2], [Pet]), [Name] ([Face Recog.]).

## Using the [Rec] Menu

For details on [Rec] menu settings, refer to [P46](#).

### [Aspect Ratio]

**Applicable modes:**         

This allows you to select the aspect ratio of the pictures to suit printing or the playback method.

Settings	Description of settings
<b>[4:3]</b>	[Aspect Ratio] of a 4:3 TV
<b>[3:2]</b>	[Aspect Ratio] of a 35 mm film camera
<b>[16:9]</b>	[Aspect Ratio] of a high-definition TV, etc.
<b>[1:1]</b>	Square aspect ratio

#### Note

- The ends of the recorded pictures may be cut at printing so check before printing. ([P202](#))

## [Picture Size]

Applicable modes:

Set the number of pixels. The higher the numbers of pixels, the finer the detail of the pictures will appear even when they are printed onto large sheets.

[Aspect Ratio]: [4:3]

Settings	Picture Size
[12M]	4000×3000
[8M ]*	3264×2448
[5M ]*	2560×1920
[3M ]*	2048×1536
[2M ]*	1600×1200
[0.3M ]*	640×480

[Aspect Ratio]: [16:9]

Settings	Picture Size
[10.5M]	4000×2672
[7M ]*	3264×2176
[4.5M ]*	2560×1712
[2.5M ]*	2048×1360
[0.3M ]*	640×424

[Aspect Ratio]: [16:9]

Settings	Picture Size
[9M]	4000×2248
[6M ]*	3264×1840
[3.5M ]*	2560×1440
[2M ]*	1920×1080
[0.2M ]*	640×360

[Aspect Ratio]: [1:1]

Settings	Picture Size
[9M]	2992×2992
[6M ]*	2448×2448
[3.5M ]*	1920×1920
[2.5M ]*	1536×1536
[0.2M ]*	480×480

\* This item cannot be set in the Intelligent Auto Mode.



**Note**

- If you change the aspect ratio, set the picture size again.
- In specific modes, Extra Optical Zoom cannot be used, and the picture size for [] is not displayed. For details regarding modes in which Extra Optical Zoom cannot be used, refer to P64.
- Pictures may appear mosaic depending on the subject and the recording conditions.

## [Quality]

Applicable modes:        

Set the compression rate at which the pictures are to be stored.

Settings	Description of settings
 ([Fine])	When giving priority to the picture quality
 ([Standard])	When using the standard picture quality and increasing the number of pictures to be recorded without changing the number of pixels

 **Note**

- The setting is fixed to  in [Handheld Night Shot] or [High Sens.] in Scene Mode.
- The following icons are displayed during the 3D recording.

 ([3D+Fine]): Both MPO images and fine JPEG images are recorded simultaneously.

 ([3D+Standard]): Both MPO images and standard JPEG images are recorded simultaneously.

## [Sensitivity]

**Applicable modes:**                           

## [White Balance]

**Applicable modes:**                           

## ■ Auto White Balance

Depending on the conditions when pictures are taken, the pictures may take on a reddish or bluish tinge. Furthermore, when a multiple number of light sources are being used or there is nothing with a colour close to white, Auto White Balance may not function properly. In this case, set the White Balance to a mode other than [AWB].

- 1 Auto White Balance will work within this range.
  - 2 Blue sky
  - 3 Cloudy sky (Rain)
  - 4 Shade
  - 5 Sunlight
  - 6 White fluorescent light
  - 7 Incandescent light bulb
  - 8 Sunrise and sunset
  - 9 Candlelight
- K=Kelvin colour temperature

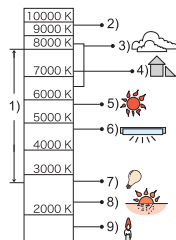

## Setting the White Balance manually

Set the White Balance value. Use to match the condition when taking photographs.

- 1 Select [MENU/SET] and then press [MENU/SET].
- 2 Aim the camera at a sheet of white paper etc. so that the frame in the centre is filled by the white object only and then press [MENU/SET].
  - White Balance may not be set when the subject is too bright or too dark. Set the White Balance again after adjusting to appropriate brightness.
  - Exit the menu after it is set.

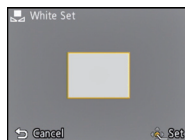

## Finely adjusting the White Balance

You can finely adjust the White Balance when you cannot acquire the desired hue by setting the White Balance.

- Fine adjustment is possible only when the White Balance is set to [☀]/[☀]/[☀]/[☀]/[☀].

**1 Select the White Balance to finely adjust and then press [DISP.] to display [WB Adjust.].**

**2 Press ◀/▶ to adjust the White Balance.**

◀ [Red]: Press when the hue is bluish.

▶ [Blue]: Press when the hue is reddish.

- Select [0] to return to the original White Balance.

**3 Press [MENU/SET] to finish.**

### Note

- The White Balance icon on the screen turns red or blue.
- The White Balance fine adjustment setting is reflected in the picture when using the flash.
- You can finely adjust the White Balance independently for each White Balance item.
- The White Balance fine adjustment setting is memorised even if the camera is turned off.
- The White Balance fine adjustment level in [☀] returns to [0] when you reset the White Balance using [☀]SET.
- In the [Beach & Snorkeling] or [Underwater] Mode, the White Balance is fixed at [AWB], but it can be finely adjusted.
- White Balance fine adjustment cannot be set for [B&W] and [SEPIA] in [Color Mode].

## [AF Mode]

**Applicable modes:**

This allows the focusing method that suits the positions and number of the subjects to be selected.

Settings	Description of settings
([Face Detection])	The camera automatically detects the person's face. (max. 15 areas) The focus and exposure can then be adjusted to fit that face no matter what portion of the picture it is in.
([AF Tracking])* <sup>1</sup>	Focus can be adjusted to a specified subject. Focus will keep on following the subject even if it moves. (Dynamic Tracking)
([23-Area])* <sup>2</sup>	Up to 23 points for each AF area can be focused. This is effective when the subject is not in the centre of the screen. (AF area frame will be same as image aspect ratio setting.)
([1-Area])	The camera focuses on the subject in the AF area on the centre of the screen.
([Spot])* <sup>2</sup>	The camera focuses on a limited narrow area in the screen.

\*<sup>1</sup> will be used during recording motion pictures or using [Time Lapse Shot].

\*<sup>2</sup> will be used during recording motion pictures.

### Note

- The focus setting is fixed to in Miniature Effect Mode.
- It will be fixed to when the [Face Recog.] is set to [ON].
- It is not possible to set in the following cases.
  - [Underwater]
  - In [Panorama Shot], [Night Scenery], [Handheld Night Shot] and [Food] in Scene Mode.
- It cannot be set to in the following conditions.
  - In [Panorama Shot] in Scene Mode
  - In [B&W] or [SEPIA] in [Color Mode]

## ■ About [👤] ([Face Detection])

The following AF area frames are displayed when the camera detects the faces.

Yellow:

When the shutter button is pressed halfway, the frame turns green when the camera is focused.

White:

Displayed when more than one face is detected. Other faces that are the same distance away as faces within the yellow AF areas are also focused.



### Note

- Under certain picture-taking conditions, including the following cases, the face detection function may fail to work, making it impossible to detect faces. [AF Mode] is switched to [AF-ON] ([🔍]) while motion pictures are taken).
  - When the face is not facing the camera
  - When the face is at an angle
  - When the face is extremely bright or dark
  - When there is little contrast on the faces
  - When the facial features are hidden behind sunglasses, etc.
  - When the face appears small on the screen
  - When there is rapid movement
  - When the subject is other than a human being
  - When the camera is shaking
  - When Digital Zoom is used
  - Taking pictures underwater
- If the camera is registering something other than someone's face, change the settings to something other than [👤].

## ■ Setting up [🔍] ([AF Tracking])

**Align the subject with the AF tracking frame, and then press ▼ to lock onto the subject.**

Ⓐ AF tracking frame

- AF area will be displayed in yellow when a subject is recognised, and focus will automatically adjust continuously following the subject's movement (Dynamic tracking).
- AF tracking is cancelled when ▼ is pressed again.



### Note

- Dynamic tracking function may not work in the following cases:
  - When the subject is too small
  - When the recording location is too dark or bright
  - When the subject is moving too fast
  - When the background has the same or similar colour to the subject
  - When jitter is occurring
  - When using the zoom
  - Taking picture underwater
- When the lock fails, the AF tracking frame will turn red and then disappear. Press ▼ again.
- The camera records pictures with [AF Mode] as [🔍] when locked or Dynamic Tracking is not working.

## [Quick AF]

**Applicable modes:**        

As long as the camera is held steady, the camera will automatically adjust the focus and focus adjustment will then be quicker when the shutter is pressed. This is useful when you do not want to miss a picture-taking opportunity.

**Settings:** [ON]/[OFF]

-  **Note**
- The battery will be consumed faster than usual.
  - Press the shutter button halfway again when it is difficult to focus on the subject.
  - It does not operate during AF tracking.
  - [Quick AF] cannot be set when in [Night Portrait], [Night Scenery] and [Handheld Night Shot] in Scene Mode.

## [Face Recog.]

- Refer to [P86](#) for details.

## [i.Exposure]

**Applicable modes:**        

Contrast and exposure will be adjusted automatically when there is a big difference in brightness between the background and subject, to bring the image close to real life.

**Settings:** [ON]/[OFF]

-  **Note**
- [i.ⓘ] in the screen turns to yellow when [i.Exposure] is in effect.
  - Even when the [Sensitivity] is set to [100], [Sensitivity] may be set higher than [100] if the picture is taken with [i.Exposure] set to valid.
  - Compensation effect may not be achieved depending on the conditions.

## [Min. Shtr Speed]

**Applicable modes:**  **P** **M** **A** **S** **L** **B** **SCN 3D**

You can take bright pictures in dark places by setting [Min. Shtr Speed] slower. Also, you can set it faster to reduce the blur of the subject.

**Settings:** [AUTO], [1/125], [1/60], [1/30], [1/15], [1/8], [1/4], [1/2], [1]

Minimum shutter speed setting	[1/125] ←	→ [1]
<b>Brightness</b>	Darker	Brighter
<b>Jitter</b>	Less	More

### Note

- This should usually be set to [AUTO] to take pictures. (When you select a minimum shutter speed other than [AUTO], [M] appears on the screen.)
- When [AUTO] is selected, shutter speed may be set up to 1 second when there is not much jitter to adjust with the [Stabilizer], or when [Stabilizer] is set to [OFF].
- Setting [Min. Shtr Speed] to slower speed might increase the chance of jitter, so we recommend using a tripod and the self-timer for taking pictures.
- Setting [Min. Shtr Speed] to faster speed might make the picture darker, so we recommend recording the picture in well-lit area. If correct exposure cannot be achieved, [M] will flash in red when the shutter button is pressed halfway.

## [i.Resolution]

**Applicable modes:**  **P** **M**      SCN 3D

Pictures with sharp profile and resolution can be taken by utilising the Intelligent Resolution Technology.

Settings	Description of settings
[ON]	[i.Resolution] is activated.
[i.ZOOM]	[i.Resolution] is activated, and zoom magnification increased to approx. 2 times while limiting deterioration of the picture.
[OFF]	—

 **Note**

- Refer to [P63](#) for information about the Intelligent Zoom.

## [Digital Zoom]

**Applicable modes:**  **P** **M**      SCN 3D

This can enlarge subjects even more than the Optical Zoom, Extra Optical Zoom, or [i.ZOOM].

**Settings:** [ON]/[OFF]



 **Note**

- Refer to [P63](#) for details.
- The setting is fixed to [ON] in Macro Zoom Mode.

## [Burst]

Applicable modes:         3D

Pictures are taken continuously while the shutter button is pressed.

Settings	Description of settings	
 ((Burst On))	<b>Burst speed</b>	approx. 3.7 pictures/second
	<b>Number of recordable pictures</b>	max. 6 pictures
	<ul style="list-style-type: none"> <li>• Focus, exposure, and White Balance will be fixed to the settings for the first picture. Depending on changes in the brightness of the subject, the recording may be brighter or darker from the second picture.</li> <li>• The Burst speed (pictures/second) may become slower depending on the recording environment, such as in dark places, if the ISO sensitivity is high etc.</li> </ul>	
 ((Hi-Speed Burst))	<b>Burst speed</b>	approx. 10 pictures/second
	<b>Number of recordable pictures</b>	max. 100 pictures
	<ul style="list-style-type: none"> <li>• This can be set only during Programme AE Mode.</li> <li>• The picture size is fixed to 3M (4:3), 2.5M (3:2), 2M (16:9) or 2.5M (1:1).</li> <li>• The Burst speed changes according to the recording conditions.</li> <li>• The number of Burst recording pictures are limited by the picture-taking conditions and the type and/or status of the card used.</li> <li>• The number of Burst recording pictures may increase when you use a card with fast writing speed or card is formatted.</li> <li>• The focus, zoom, exposure, White Balance, shutter speed and ISO sensitivity are fixed to the settings for the first picture.</li> <li>• The ISO sensitivity is automatically adjusted. However, the ISO sensitivity is increased to make the shutter speed become high-speed.</li> <li>• Depending on the operating conditions, it may take time to take the next picture if you repeat taking a picture.</li> </ul>	
 ((Flash Burst))	<b>Number of recordable pictures</b>	max. 5 pictures
	<ul style="list-style-type: none"> <li>• Still pictures are taken continuously with flash.</li> <li>• This can be set only during Programme AE Mode.</li> <li>• The picture size is fixed to 3M (4:3), 2.5M (3:2), 2M (16:9) or 2.5M (1:1).</li> <li>• Settings for focus, zoom, exposure, shutter speed, ISO sensitivity, flash output are fixed to the first picture.</li> <li>• Number of recordable pictures will be fixed to 5 pictures when the self-timer is used.</li> <li>• <b>The flash setting is fixed to [⚡].</b></li> </ul>	
	[OFF]	

 **Note**

- Burst Mode is not cancelled when the camera is turned off.
- If you take pictures in Burst Mode with the built-in memory, it will take time to write the picture data.
- You cannot use the Burst in following conditions.
  - In [Panorama Shot] or [Handheld Night Shot] in Scene Mode
  - When using [Time Lapse Shot]
- Number of recordable pictures will be fixed to 3 pictures when the self-timer is used (except for [⏱]).
- **The flash setting is fixed to [☺] (except for [📷]).**

## [Time Lapse Shot]

Applicable modes:  P M      SCN 3D

You can set the recording start time, the recording interval and the number of pictures, and automatically record subjects such as animals and plants as time elapses.

- Set the date and time settings in advance. (P27)
- It cannot be recorded into the built-in memory. Please use a card.

### ■ Set the recording time/interval/number of pictures

- 1 Press **◀/▶** to select the settings and press **▲/▼** to set.

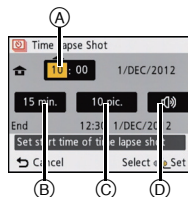

Settings	Description of settings
Start time <b>(A)</b>	You can set the time to start recording. Any time up to 12 hours ahead can be set.
Recording interval <b>(B)</b>	An interval of up to 30 minutes can be set in units of 1 minute. • For certain shutter speed settings, the minimum interval is 5 minutes.
Number of pictures <b>(C)</b>	10, 20, 30, 40, 50, 60
Recording warning <b>(D)</b>	<b>[🔊]</b> : The user is notified that recording is to start by a warning sound and flashing AF assist lamp. <b>[🔊]</b> : There is no warning sound. Also, the AF assist lamp doesn't flash.

- 2 Press **[MENU/SET]**.

- 3 Press the shutter button fully.

- When the recording time arrives, the recording starts automatically.
- If the current time has already passed the set start time, the recording starts when the shutter button is pressed.
- During recording standby, the power will turn off automatically if no operation is performed for a certain period. The Time Lapse Shot is continued even with the power turned off. When the recording start time arrives, the power turns on automatically. To turn on the power manually, press the camera [ON/OFF] button or press and hold **[🔊]**.
- To stop the Time Lapse Shooting partway through, press **[MENU/SET]** or **[🔊]** and end the recording on the displayed confirmation screen.

 **Note**

- This function is not for use in a security camera.
- **If you leave the unit somewhere to perform [Time Lapse Shot], please be careful of theft.**
- **We do not recommend using [Time Lapse Shot] while underwater.**
- **Recording for long periods in cold places such as ski resorts or places at high altitude, or in warm, wet environments may cause a malfunction, so please be careful.**
- When the recording warning is set to [α(β)], a warning sound will be emitted. Check this setting is suitable for the recording environment.
- The unit is fixed to the zoom position prior to the start of recording.
- It cannot be used in [Panorama Shot] in Scene Mode.
- When using [Time Lapse Shot], the GPS positioning cannot be worked.
- We recommend to use a fully charged battery.
- [Time Lapse Shot] will be cancelled partway through in the following cases.
  - When the charge on the battery runs out
  - When the number of recordable pictures drops to none

## Playing back pictures taken in [Time Lapse Shot]

Pictures taken in [Time Lapse Shot] are stored in groups, each containing the series of pictures recorded in a single Time Lapse Shot. The [📷] icon is displayed for the group.

- Deleting and editing in a group unit is possible. (For example, if you delete a picture group with [📷], all the pictures in that group are deleted.)



### ■ Continuously playing back

Press ◀▶ to select a picture with the [📷] icon, and then press ▲.

▲	Play/Pause	
▼	Stop	
◀	Fast rewind, Previous picture*	
▶	Fast forward, Next picture*	

\* These operations can be performed only in the Pause Mode.

### ■ Playing back each picture

**1** Press ◀▶ to select a picture with the [📷] icon, and then press ▼.

**2** Press ◀▶ to select the picture.

- Press ▼ again to return to the normal playback screen.
- [Playback] menu cannot be used.
- Operations similar to those for Normal Play can be used on the pictures in the group. (Multi playback, playback zoom, deleting the pictures, etc.)



#### Note

- If you delete all pictures except one in the group, that picture will be saved as a single picture.

## [Color Mode]

**Applicable modes:**         

Sets various colour effects, including making the picture sharper, brighter, or applying a sepia tone.

Settings	Description of settings
[STANDARD]	This is the standard setting.
[Happy]* <sup>1</sup>	Image with enhanced brightness and vividness.
[VIVID]* <sup>2</sup>	The picture becomes sharper.
[B&W]	The picture becomes black and white.
[SEPIA]	The picture becomes sepia.

\*1 This can be set only when Intelligent Auto Mode is set.

\*2 This can be set only during Programme AE Mode or Manual Exposure Mode.

## [AF Assist Lamp]

**Applicable modes:**         

AF assist lamp will illuminate the subject when the shutter button is pressed half-way making it easier for the camera to focus when recording in low light conditions. (Larger AF area is displayed depending on the recording conditions.)

**Settings:** [ON]/[OFF]

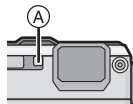

 **Note**

- The effective distance of the AF Assist Lamp is a maximum of approximately 1.5 m (4.9 feet).
- When you do not want to use the AF Assist Lamp  (e.g. when taking pictures of animals in dark places), set the [AF Assist Lamp] to [OFF]. In this case, it will become more difficult to focus on the subject.
- [AF Assist Lamp] is fixed to [OFF] in [Scenery], [Night Scenery], [Handheld Night Shot], [Sunset] and [Glass Through] in Scene Mode.



## [Red-Eye Removal]

**Applicable modes:** 

When Red-Eye Reduction ([, [) is selected, Digital Red-Eye Correction is performed whenever the flash is used. The camera automatically detects red-eye and corrects the picture.

**Settings:** [ON]/[OFF]

 **Note**

- Only available when [AF Mode] is set to [] and Face Detection is active.
- Under certain circumstances, red-eye cannot be corrected.

## [Stabilizer]

**Applicable modes:** 

Using this mode, jitter during picture taking is detected, and the camera automatically compensates for the jitter, enabling jitter-free images to be taken.

When recording motion pictures, “Active Mode” (stabiliser for motion pictures) will automatically function. This decreases the jitter of the image when recording motion pictures while walking, etc.

**Settings:** [ON]/[OFF]

 **Note**

- Stabiliser is fixed to [OFF] in [Panorama Shot] in Scene Mode.
- The setting is fixed to [ON] in [Handheld Night Shot] in Scene Mode.
- During motion picture recording, this setting is fixed to [ON] and “Active Mode” works. Note that “Active Mode” does not work when [Rec Quality] is set to [VGA] in [MP4].
- In “Active Mode”, stronger effect of the correction can be achieved at the wide end.
- The stabiliser function may not be effective in the following cases.
  - Be careful of camera jitter when you press the shutter button.
    - When there is a lot of jitter.
    - When the zoom magnification is high.
    - In Digital Zoom range.
    - When taking pictures while following a moving subject.
    - When the shutter speed becomes slower to take pictures indoors or in dark places.

## [Date Stamp]

**Applicable modes:**        

You can take a picture with date and time of recording.

Settings	Description of settings
[W/O TIME]	Stamp the year, month, and day.
[WITH TIME]	Stamp the year, month, day, hour, and minutes.
[OFF]	—

### Note

- **Date information for pictures recorded with the [Date Stamp] set cannot be deleted.**
- **When printing pictures with [Date Stamp] at a shop or with a printer, the date will be printed on top of the other if you choose to print with the date.**
- If the time has not been set, you cannot stamp with the date information.
- The setting is fixed to [OFF] in the following cases.
  - When using Auto Bracket
  - In [Panorama Shot] in Scene Mode
  - When using [Burst]
  - When recording motion pictures
- [Text Stamp], [Resize] and [Cropping] cannot be set for pictures recorded with [Date Stamp] set.
- Even if you take a picture with [Date Stamp] set to [OFF], it is possible to stamp dates into the recorded pictures using [Text Stamp] (P143) or setup the Date print (P150, 171).

## [Clock Set]

- Refer to P27 for details.

## Using the [Motion Picture] Menu

For details on [Motion Picture] menu settings, refer to [P46](#).

In [Panorama Shot] in Scene Mode, the [Motion Picture] menu will not be displayed.

### [Rec Mode]

Applicable modes: 

This sets up the data format of motion pictures.

Settings	Description of settings
[AVCHD]	Select this format to record HD (high definition) video for playback on your HDTV using an HDMI connection.
[MP4]	Select this format to record standard definition video for playback on your PC.

## [Rec Quality]

Applicable modes: 

This sets up the picture quality of motion pictures.

## When [AVCHD] is selected

Settings	Picture size/Bit rate	fps	Aspect ratio
[GFS]	1920×1080 pixels/Approx. 17 Mbps	50i (CCD output is 25 fps)	16:9
[FSH]			
[GS]	1280×720 pixels/Approx. 17 Mbps	50p (CCD output is 25 fps)	
[SH]			

- GPS information can be stored when you record with [AVCHD] set to [GFS] or [GS].

## When [MP4] is selected

Settings	Picture size/Bit rate	fps	Aspect ratio
[FHD]	1920×1080 pixels/Approx. 20 Mbps	25	16:9
[HD]	1280×720 pixels/Approx. 10 Mbps		4:3
[VGA]	640×480 pixels/Approx. 4 Mbps		

 **Note**

- What is bit rate

This is the volume of data for a definite period of time, and the quality becomes higher when the number gets bigger. This unit is using the “VBR” recording method. “VBR” is an abbreviation of “Variable Bit Rate”, and the bit rate (volume of data for definite period of time) is changed automatically depending on the subject to record. Therefore, the recording time is shortened when a subject with fast movement is recorded.

## [Continuous AF]

**Applicable modes:** 

It will continually keep on focusing to the subject that the focus was once set.

**Settings:** [ON]/[OFF]

 **Note**

- Set this function to [OFF] if you wish to fix the focus on the position where you started the Motion Picture Recording.

## [Wind Cut]

**Applicable modes:** 

This reduces the wind noise in the audio recording.

**Settings:** [ON]/[OFF]

 **Note**

- Sound quality will be different than usual when [Wind Cut] is set.

Applicable modes:         

## Recording using the GPS function

Before use, read “About the GPS” on P7 and “User License Agreement for Location Name data” on P184.

### ■ About the “GPS”

GPS is an abbreviation of [Global Positioning System], which is a system that allows you to check your position utilising GPS satellites.

Calculating the current position by receiving radio waves including orbit information and clock information from multiple GPS satellites is called positioning.

The unit can record location name information and latitude/longitude for the recorded image and automatically correct the time.

### ■ Receiving signals from GPS satellites

- It is recommended to use by holding the camera still for a while at an outdoor location clear to the sky, with the antenna pointed upward.
- Radio waves from GPS satellites cannot be received properly at the following locations, so the positioning may not be possible or a significant error may occur.
  - Indoor/underground or underwater/in the woods/travelling in a train or a car etc./close to or between buildings/close to high voltage lines/inside a tunnel/close to mobile phones working on 1.5 GHz band etc.

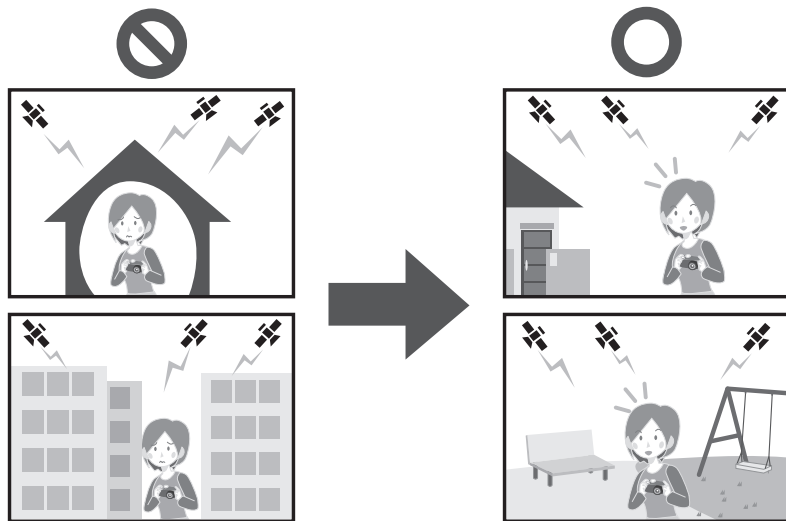

- Do not cover the GPS antenna with your hands etc.
- Do not carry the unit inside a metallic case or similar when positioning. Positioning is not possible when the unit is covered by metal etc.

## Acquiring of the GPS information

When [GPS Setting] is set to [ON], positioning is performed at regular intervals. When the positioning is successful, location name information and latitude/longitude are acquired. For details on the screen display for the acquired information, read "About the display of positioning status and positioning results" on P116.

- If GPS automatic time correction is set in the time settings at the time of purchase, [GPS Setting] will be set to [ON] automatically.

**1** Select [GPS Setting] on the [GPS/Sensor] menu, and then press [MENU/SET].

**2** Press ▲/▼ to select the settings and then press [MENU/SET].

Settings	Description of settings
[ON]	Set the unit to receive the GPS satellite radio waves. • Positioning continues even when the power is turned off.
[OFF]	—
[INFO]	You can confirm and update the current reception status. • For detail, refer to "Update the GPS information" on P118.

- Exit the menu after it is set.
- GPS status indicator is lit during the positioning.  
Also, when the GPS status indicator is lit with the power turned off, [GPS Setting] is set to [ON].

Ⓐ GPS status indicator

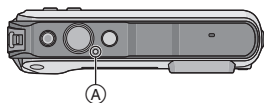

### Note

- When [GPS Setting] is set to [ON], the GPS function will operate even when the power is turned off. Electromagnetic waves from this unit may affect other electronic devices, so set [GPS Setting] to [OFF] or [Airplane Mode] to [ON] and turn the unit off when you carry this unit onboard an airplane or inside a hospital, etc.

## About the display of positioning status and positioning results

When the GPS begins positioning, an icon indicating the positioning status is displayed on the recording screen. When the positioning is successful, the location name information and latitude/longitude are displayed.

- (A) Location name information
- (B) Icon indicating positioning status
- (C) Icon indicating positioning results



### ■ About the Icon indicating positioning status

Positioning is performed by this unit when radio waves from 3 or more GPS satellites are received.



- The bar moves up the scale according to the number of GPS satellites from which signals are being received.
- When the bar has filled the scale and positioning has been successful, the indicator goes blue.
- Even when reception is good, there may be times when positioning is not possible due to the status of the GPS satellites. In this case, we recommend performing [Repositioning] (P118).

### ■ About the Icon indicating positioning results

	Elapsed time after successful positioning
[GPS <sub>5</sub> ]	Within the last 5 minutes
[GPS <sub>60</sub> ]	Between 5 minutes and 1 hour ago
[GPS <sub>120</sub> ]	Between 1 hour and 2 hours ago
[GPS <sub>120+</sub> ]	More than 2 hours ago
[GPS <sub>no</sub> ]	When positioning was not possible

### ■ When positioning is taking a long time

Under the following conditions, successful positioning may take 2 to 3 minutes even when reception is good.

- When positioning is performed for the first time
- When reception has been poor for a significant time
- After changing the battery
- When the camera has been left for a significant time without being turned on
- When the camera has been moved a long way from the last location of successful reception
- When [GPS Setting] is set to [OFF]
- When [Airplane Mode] is set to [ON] and the power is turned off

### ■ Displayed location name information

- Country/region
- Prefecture/state
- City/ward/county
- Town/village
- Landmark
- Latitude/longitude (displayed by pressing [DISP.] several times to switch among the environment information screen)

The location name information and latitude/longitude displayed on success of the positioning are recorded in the recorded still pictures and motion pictures\*.

For images containing such information, [GPS] is displayed at playback.

- \* Information can only be recorded when recording using [MP4] or [GFS]/[GS] in [AVCHD].  
Note that only the information measured at the start of the recording is recorded.

Valid information for the current position is displayed as location name information by searching the location names and landmarks in the database in this unit based on the latitude/longitude from the positioning. (It may not display the closest location.)

- [---] is displayed when there is no valid information even when the positioning is successful.
- Even when the location name information is displayed as [---], it may be possible to select the location name information with [GPS Area Select] (P119).
- Desired landmark may not be registered. Location name information is as of December 2011. For details of the types of landmark, refer to "Landmark types" on P189.
- Location name information (location names or landmark names) may be different from the official names.

## Update the GPS information

When the displayed location name information is different from the current location or when the positioning is not successful, move to a location where the radio waves from GPS satellites can be received better and perform the positioning update.

- When significant time has elapsed since the last successful positioning ([GPS], [GPS], [GPS] and [GPS] are displayed), we recommend performing a positioning update.

### Select [Repositioning] on the [GPS/Sensor] menu, and then press [MENU/SET].

- Positioning is started and the current location information is updated once the positioning is successful.
- Positioning also can be updated by selecting [GPS] from the Quick Menu (P48), and then pressing [MENU/SET].

### ■ Checking the GPS reception status before updating

**1** Select [GPS Setting] on the [GPS/Sensor] menu, and then press [MENU/SET].

**2** Press ▲/▼ to select [INFO] and then press [MENU/SET].

- Last updated positioning result is displayed.

[🕒]	Time positioning was performed
[📶]	Number of GPS satellites received from
[GPS]	Latitude Longitude

**3** Press [MENU/SET] in the information confirmation screen.

- Positioning is started and the current location information is updated once the positioning is successful.

### ■ About automatic updating of positioning

- Even if you do not perform [Repositioning], it will perform the positioning automatically right after the power is turned on, and in constant time intervals.
- When [GPS Setting] is set to [ON], the unit will continue to perform the positioning at a constant time interval even if the power is turned off. Note that if [Airplane Mode] has been set to [ON], positioning will not be performed when the power is turned off.
- Positioning with the power turned off is cancelled in the following cases:
  - When the remaining battery power becomes [🔋]
  - When the power is not turned on for a specific period of time

## Change the recorded location name information

When the information acquired by the positioning is different from the current location, it is possible to change it by selecting the desired location name or landmark from the selectable candidates registered in the database of this unit.

- Other location name information can be selected when  is displayed with the location name information.

- 1** Select **[GPS Area Select]** on the **[GPS/Sensor]** menu, and then press **[MENU/SET]**.
- 2** Press **▲/▼** to select the item to change, and then press **[MENU/SET]**.
- 3** Press **▲/▼** to select the location name or landmark from the candidates, and then press **[MENU/SET]**.

### ■ When not storing the location name or the landmark in the recorded pictures

When not storing all the location name information:

#### Select **[Delete all place-names]** in above step 2

- Confirmation screen is displayed. All the displayed location name information is deleted and the information will not be stored from the next time a picture is recorded when **[Yes]** is selected.

When not storing specific location name information:

#### Select **[Delete country], etc., in above step 3**

- Confirmation screen is displayed. All the items inferior to the deleted item are deleted and the information will not be stored from the next time a picture is recorded when **[Yes]** is selected. (Example: When the **[State/Prov./County]** is deleted, **[County/Township]**, **[City/Town/Village]** and **[Landmark]** that are inferior to it are also deleted.)

#### Note

- To restore the location name information deleted, set them again.
- When desired location name or landmark is not displayed among the candidates, perform **[My Landmark]** (P120) before taking a picture, or perform **[Place-Name Edit]** (P142) after taking a picture.
- Latitude/longitude is not deleted even when the location name or landmark is deleted. Turn **[GPS Setting]** to **[OFF]** if you would not like to store the latitude/longitude.

## Switch between displaying and hiding the location name information

Switches the displaying and hiding of the location name information displayed on the screen.

- 1** Select **[Area Info. Set]** on the **[GPS/Sensor]** menu, and then press **[MENU/SET]**.
- 2** Press **▲/▼** to select the item to change, and then press **[MENU/SET]**.
- 3** Select **[ON]** for the items to display and **[OFF]** for the items not to display by pressing **▲/▼**, and then press **[MENU/SET]**.

## Register additional landmarks

Additionally register new landmarks in the database of this unit. It can be displayed on the screen or stored as a positioning result once registered.

- 1** Select **[My Landmark]** on the **[GPS/Sensor]** menu, and then press **[MENU/SET]**.
- 2** Press **▲/▼** to select **[None]**, and then press **[MENU/SET]**.
  - Confirmation screen is displayed. Positioning is started when [Yes] is selected.
  - Current location information is displayed once the positioning is successful.
- 3** After confirming the GPS information, press **[MENU/SET]**.
- 4** Enter landmark name.
  - For details on how to enter characters, refer to “Entering Text” on [P90](#).

### ■ Change or delete registered landmark names

- 1** Select registered landmark name in above step 2, and then press **[MENU/SET]**.
- 2** Press **◀/▶** to select **[Edit]** or **[Delete]**, and then press **[MENU/SET]**.
  - Text input screen is displayed when [Edit] is selected. Enter the landmark name again.
  - The registered landmark is deleted when [Delete] is selected.

### Note

- Up to 50 landmarks can be additionally registered.

Applicable modes:         

## Sensors (compass/altimeter/barometer) are operated

The direction, altitude, and atmospheric pressure can be measured and recorded in the recorded images.

- If compass/altimeter/barometer are operated in the time settings (P27) at the time of purchase, [GPS Setting] will be set to [ON] automatically.

**1** Select [Sensor Settings] on the [GPS/Sensor] menu, and then press [MENU/SET].

**2** Press ▲/▼ to select [ON], and then press [MENU/SET].

- Exit the menu after it is set.
- To switch the environment information screen, press [DISP.] several times.

- (A) Compass
- (B) Altimeter
- (C) Latitude
- (D) Longitude
- (E) Time positioning was performed
- (F) Barometer

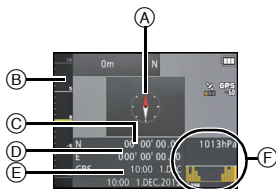

### Note

- When [GPS Setting] is set to [OFF], the latitude/longitude and positioning timing are not displayed.
  - They keep working when the power is turned off. If you do not wish the compass/altimeter/barometer to keep working when the power is turned off, set [Airplane Mode] to [ON]. (P131)
  - For motion pictures\*, the direction, altitude and atmospheric pressure measured at the start of the recording are recorded.
- \* When recording using [MP4] or [GFS]/[GS] in [AVCHD]

Applicable modes: 

## Using the altimeter

You can check the altitude of the current location.

- Displaying range is -600 m (-2000 feet) to 9000 m (30000 feet).
- A depth meter will be displayed instead of the altimeter in [Beach & Snorkeling] mode.

For details about the depth meter, please read [P74](#).

- (A) Altitude
- (B) Current altitude

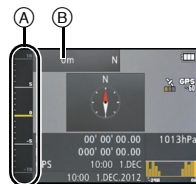

### ■ About altitude conversion

The displayed altitude is a relative altitude<sup>\*1</sup>. The altitude is a value calculated by converting an atmospheric pressure within the unit to an altitude with 0 m (0 feet) (sea level) = 1013 hPa<sup>\*2</sup> as a reference.

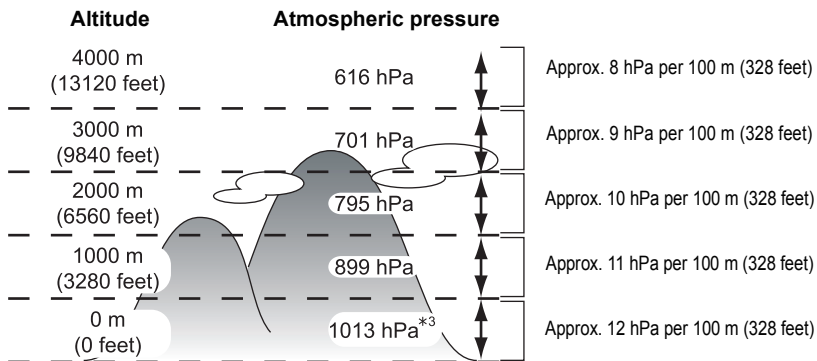

<sup>\*1</sup> Altitude can be expressed in two forms — as an altitude above sea level (absolute height from sea surface) or as a relative altitude (difference in altitude between two locations). This unit displays a relative altitude estimated by a method which uses the relationship between the altitude and atmospheric pressure in the ISA [International Standard Atmosphere], as specified by the ICAO [International Civil Aviation Organization].

<sup>\*2</sup> "hPa (hectopascal)" is a unit used to represent atmospheric pressure.

<sup>\*3</sup> Readings fluctuate with the weather. Adjust frequently with [Adjust] ([P123](#)) in [Altimeter].

## Adjusting the Altimeter

The altimeter can be adjusted manually or using GPS.

To measure altitude with greater accuracy, we recommend that you perform [Adjust] regularly by comparing a reference altitude on a sign or other accurate altitude information with the altitude indicated by the unit.

- 1** Select [Altimeter] on the [GPS/Sensor] menu, and then press [MENU/SET].
- 2** Press ▲/▼ to select [Adjust], and then press [MENU/SET].
- 3** Press ▲/▼ to select the settings, and then press [MENU/SET].

Settings	Description of settings
[GPS]	Use the GPS information to adjust the altimeter. <ul style="list-style-type: none"> <li>• The [GPS Setting] turns [ON] automatically.</li> <li>• The adjusted altitude may show errors of more than approximately <math>\pm 50</math> m (164 feet) depending on the positions of the GPS satellites.</li> <li>• When altitude adjusted based on successful positioning has an error larger than this, we recommend that you select [ON] and make manual adjustments.</li> <li>• Even when GPS positioning is successful, the altitude can be affected by satellite positioning and signal conditions. In this case, the altimeter will not be adjusted.</li> <li>• When [GPS Setting] is set to [OFF], [Adjust] is automatically set to [ON].</li> </ul>
[ON]	Adjust the altitude manually. <b>Press ◀/▶ to select the items, and press ▲/▼ to set.</b> <ul style="list-style-type: none"> <li>• It can be adjusted to between <math>-599</math> m (<math>-1999</math> feet) and <math>8999</math> m (<math>29999</math> feet).</li> </ul>
[OFF]	The adjusted altitude value is restored to the value which is before you adjust.

■ **Example of adjusting the altitude manually**  
**(measuring the height from the ground to the roof of a building)**

- 1** Set [ON] in [Adjust] in [Altimeter] on the ground (A), and then set the altimeter to 0 m (0 feet).
- 2** Move from the ground (A) to the roof (B).
- 3** Check the altitude measured on the roof (B).

- (A) Ground
- (B) Roof
- (C) Height of building  
(relative altitude)

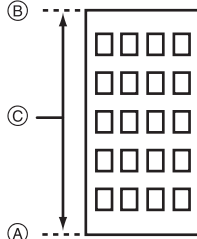

 **Note**

- When [Adjust] is set to [GPS], the altitude prior to and after recording can vary according to the timing at which GPS data is received.
- Adjustment is not possible when the measured value exceeds the display range. It will display [----].
- With the displaying of the relative altitude, it may display with negative numbers even if it is higher than sea level depending on the value adjusted with [Adjust] in [Altimeter].
- After adjustment, errors of a few metres may still occur. For information on preserving the adjusted accuracy, read "About the measured altitude and atmospheric pressure" (P128).

## Adding an altimeter log

The altitude is recorded at 15 minute intervals and displayed as a graph.

- Set the date and time settings in advance. (P27)
- It cannot be recorded into the built-in memory. Please use a card.

**1** Select **[Altimeter]** on the **[GPS/Sensor]** menu, and then press **[MENU/SET]**.

**2** Press **▲/▼** to select **[Logging]**, and then press **[MENU/SET]**.

**3** Press **▲/▼** to select **[ON]**, and then press **[MENU/SET]**.

- (A) Altimeter log 12 hours before
- (B) Latest altimeter log

- Press **[DISP.]** several times on the recording standby screen until the altitude graph display screen appears. You can view a graph of the altimeter log for the last 12 hours.

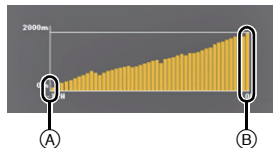

The period up to when the **[Logging]** is set to **[OFF]** is saved as a single log file. In the following cases, even if **[Logging]** is not set to **[OFF]**, the record of the altitude as a single log file will be interrupted.

- When the time settings are changed (including **[Auto Clock Set]**)
- When the **[World Time]** setting is changed
- When the battery remaining is 
- When there is insufficient space on the card

### Note

- In the following cases, altitude is not recorded.
  - When **[Airplane Mode]** is set to **[ON]** and the power is turned off
  - When **[Sensor Settings]** is set to **[OFF]**
  - **[Beach & Snorkeling]**
  - **[Underwater]**
  - When using **[Time Lapse Shot]**
  - When connecting to a PC or a printer
  - When recording motion pictures.

## Viewing the altimeter log

You can specify the period of the recorded altimeter log to display.

**1** Select [Altimeter] on the [GPS/Sensor] menu, and then press [MENU/SET].

**2** Press ▲/▼ to select [Display Log], and then press [MENU/SET].

**3** Press ▲/▼ to select the recording start date, and press [MENU/SET].

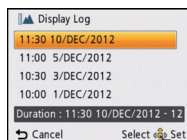

**4** Press ▲/▼/◀/▶ to select a date at which to start the period to display, and press [MENU/SET].

- It will not be displayed, if the date to start and the date to finish is the same.

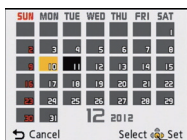

### ■ About the altitude graph

The altitude graph is displayed with the highest altitude in the log as the upper limit and the lowest altitude as the lower limit.

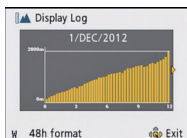

[W]/[T]	<b>Switches between the 12 hour display and the 48 hour display</b>
◀/▶	<b>Moves the log left and right</b> <ul style="list-style-type: none"> <li>• Move the log in units of 3 hours on the 12 hour display.</li> <li>• Move the log in units of 12 hours on the 48 hour display.</li> </ul>

## Deleting the altimeter log

You can delete part of the altimeter log by specifying a period.

- 1** Select **[Altimeter]** on the **[GPS/Sensor]** menu, and then press **[MENU/SET]**.
- 2** Press **▲/▼** to select **[Delete log]**, and then press **[MENU/SET]**.
- 3** Press **▲/▼** to select the recording start date, and press **[MENU/SET]**.
  - Confirmation screen is displayed. It is executed when **[Yes]** is selected.  
Exit the menu after it is executed.

Applicable modes: 

## Using the barometer

With the current atmospheric pressure as a reference, it is displayed on the graph within the range of  $-10$  hPa to  $+10$  hPa.

(Atmospheric pressure out of range cannot be displayed in details)

- (A) 24 hours earlier
- (B) Present
- (C) Time periods for which history was not recorded (white portion)
- (D) Atmospheric pressure information in 90 minute intervals

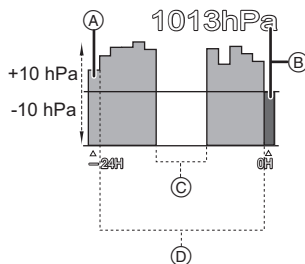

- The barometer is an indicator of changes between fine weather and rain.
  - When the atmospheric pressure rises: Weather tends to recover
  - When the atmospheric pressure drops: Weather tends to worsen

### Note

- In the following cases, atmospheric pressure is not recorded on the graph.
  - When [GPS Setting] is set to [ON], the battery is low, and the power is off
  - When [Airplane Mode] is set to [ON] and the power is off
  - When [Sensor Settings] is set to [OFF]
  - [Underwater]
- When the displayable range (current atmospheric pressure of  $-10$  hPa to  $+10$  hPa from the reference pressure) is exceeded, the atmospheric pressure will not be displayed correctly.

### About the measured altitude and atmospheric pressure

- Altitude value may show errors depending on the change in atmospheric pressure compared to areas such as locations with altimeter reference signs. Perform frequently with [Adjust] in [Altimeter].
- Altitude announced onboard an airplane is measured using the atmospheric pressure surrounding the airplane. It does not match the altitude actually measured inside the airplane.
- Even if the unit is fixed at a constant altitude, the measured altitude may fluctuate due to the effects of change in atmospheric pressure.
  - In coastal areas, the altitude changes by 1 m (3.3 feet) per 0.12 hPa.
- Altitude and atmospheric pressure may not be measured accurately in the following cases:
  - When there is a significant change in weather conditions (Pressure and air temperature)
  - When there is a movement with a rapid change in altitude
  - When pressure is applied to the front or rear of this unit\*<sup>1</sup>
  - When this unit is wet (after using underwater, etc.)\*<sup>2</sup>
  - When closing the side door\*<sup>2</sup>



\*<sup>1</sup> Hold this unit as shown in the figure when measuring.

\*<sup>2</sup> It will adapt to the ambient atmospheric pressure within a few minutes, and display correct measurement values.

Applicable modes: 

## Using the compass

8 bearings are measured based on the direction the lens of the camera is pointing in.

- The coloured portion of the compass needle points north.
- When [GPS Setting] is set to [OFF], magnetic declination is not corrected.

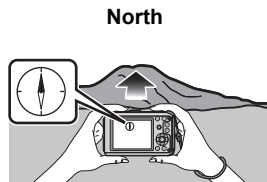

### About the declination adjustment

Earth is a giant magnet with the South Pole at the Geographic North Pole and the North Pole at the Geographic South Pole, and the magnetism the Earth has is called “geomagnetism”. There is a difference between the angle of the “magnetic north” that a magnetic compass points to and the geographical “true north” due to the effect of the “geomagnetism”. The difference between these angles is called “declination”.

The compass in this unit points “true north”, when it corrects “magnetic declination” based on the latitude and longitude acquired in the GPS positioning.

- The size of the magnetic declination can change as you move to different locations, so we recommend that you set [GPS Setting] to [ON] and perform positioning regularly to update your latitude/longitude.

### Note

- It may not measure correctly when you measure with this unit upside down.
- The bearing measurement value may be affected in locations with weak geomagnetism.
- It may not measure accurately if close to the following objects:
  - Permanent magnets (metals in magnetic necklaces, etc.)/metallic objects (steel desks, lockers, etc.)/high-voltage lines or overhead wires/household appliances (TVs, PCs, mobile phones, speakers, etc.)
- It may not measure accurately in the following locations:
  - Inside cars/trains/ships/airplanes/rooms (when the steel beams are magnetised)

## Adjusting the compass

When [X] is displayed on the compass, perform [Calibrate compass].

- 1** Select [Calibrate compass] on the [GPS/Sensor] menu, and then press [MENU/SET].
- 2** Securely hold the unit vertically, and adjust by turning it in a figure 8 a few times by rolling your wrist.
  - An adjustment completed message is displayed when the adjustment is successful.

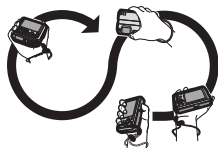

### Note

- Perform the adjustment with the strap around your wrist to avoid dropping the unit.
- When the adjustment fails, move to a location with no effect from surrounding magnetism, and perform the adjustment again.
- When the compass cannot acquire directions due to the presence of an object nearby with a strong magnetic field, etc., [X] will be displayed.

Applicable modes:  **P** **M**      **SCN** **3D**

## Restricting the GPS/sensor functions

### Disabling the GPS/sensors when the power is turned off

When [GPS Setting] or [Sensor Settings] is set to [ON], the GPS and sensor continue working when the power is turned off. Set [Airplane Mode] to [ON] to prevent GPS positioning and acquisition of direction/altitude/atmospheric pressure information when the power is turned off.

**1** Select [Airplane Mode] on the [GPS/Sensor] menu, and then press [MENU/SET].

**2** Press ▲/▼ to select [ON], and then press [MENU/SET].

- Exit the menu after it is set.

#### Note

- When both [GPS Setting] and [Sensor Settings] are set to [OFF], [Airplane Mode] is fixed to [OFF].

## Various methods of playback

You can play back the recorded pictures in various methods.

- 1** Press **[▶]**.
- 2** Press **[MODE]**.
- 3** Press **▲/▼/◀/▶** to select item, and then press **[MENU/SET]**.

• Following items can be selected.

<b>[▶]</b>	([Normal Play]) (P40)
<b>[2D/3D]</b>	([2D/3D Settings])*
<b>[▶]</b>	([Slide Show]) (P133)
<b>[▶]</b>	([Filtering Play]) (P135)
<b>[📅]</b>	([Calendar]) (P137)

\* The playback method for the 3D pictures can be switched. This item is only displayed during HDMI output. Refer to P159 for details about the playback method.

**[Slide Show]**

Recorded pictures can be played back in fixed intervals in order along with music. It is also possible to playback only the still pictures, only the motion pictures, only the 3D pictures, or pictures recorded with the location name information or the altitude information, etc., as a slide show. This method of playback is recommended when connecting to a TV and viewing the pictures.

### 1 Select the group to play back by pressing ▲/▼, and then press [MENU/SET].

- Refer to P159 for the method to play back [3D Play] pictures in 3D.
- During [Category Selection], press ▲/▼/◀/▶ to select a category, and then press [MENU/SET]. Refer to P136 for category details.

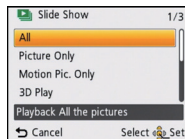

### 2 Press ▲ to select [Start] and then press [MENU/SET].

### 3 Press ▼ to finish the slide show.

- Normal Playback resumes after the slide show finishes.

#### ■ Operations performed during slide show

The cursor displayed during playback is the same as ▲/▼/◀/▶.

▲	Play/Pause	
▼	Stop	
◀	Back to previous picture*	
▶	Ahead to next picture*	
[W]	Reduce volume level	
[T]	Increase volume level	

\* It is only available in the following conditions.

- During a pause
- When playing back motion pictures
- When playing back panorama pictures
- When playing back the group of pictures taken in [Time Lapse Shot]

## ■ Changing the slide show settings

You can change the settings for Slide Show Playback by selecting [Effect] or [Setup] on the slide show menu screen.

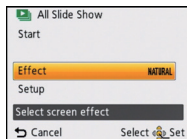

### [Effect]

This allows you to select the screen effects or music effects when switching from one picture to the next.

[NATURAL], [SLOW], [SWING], [URBAN], [OFF], [AUTO]

- When [URBAN] has been selected, the picture may appear in black and white as a screen effect.
- [AUTO] can be used only when [Category Selection] has been selected. The pictures are played back with the recommended effects in each category.
- [Effect] is fixed to [OFF] during the [Motion Pic. Only] slide show, or during a slide show of [ ] in [Category Selection].
- Some [Effect] will not operate when playing back pictures displayed vertically.

### [Setup]

[Duration] or [Repeat] can be set.

Settings	Description of settings
[Duration]	[1SEC.]/[2SEC.]/[3SEC.]/[5SEC.]
[Repeat]	[ON]/[OFF]
[Sound]	<p>[OFF]: There will be no sound.</p> <p>[AUTO]: Music is played when the still pictures are played back, and audio is played when the motion pictures are played back.</p> <p>[Music]: Music is played back.</p> <p>[Audio]: Audio (only for motion pictures) is played back.</p>

- [Duration] can be set only when [OFF] has been selected as the [Effect] setting.
- When playing back the following pictures, the [Duration] setting is disabled.
  - Motion pictures
  - Panorama pictures
  - Pictures taken in [Time Lapse Shot]





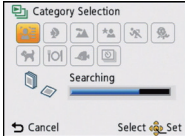





## [Filtering Play]

Pictures are classified into only still pictures, only motion pictures, or only 3D pictures etc., and played back.

Settings	Description of settings
[Picture Only]	Only still pictures are played back.
[Video Only]	Only motion pictures are played back.
[3D Play]	Only 3D pictures are played back. • Refer to <a href="#">P159</a> for the method to play back [3D Play] pictures in 3D.
[GPS Area Play]	It is possible to play back by selecting the location name or landmark of the place where it was recorded. <b>1 Press ▲/▼ to select an item and then press [MENU/SET].</b> <b>2 Press ▲/▼/◀/▶ to select the location name or landmark, and then press [MENU/SET].</b>
[Altimeter Log]	Playing back still pictures by altitude. <b>Press ▲/▼ to select the recording start date, and press [MENU/SET].</b> • Select an altitude on the graph using ◀/▶ to display still pictures recorded at that altitude. • You can change the display period of the log using the zoom button. 
[Travel]	You can play back the pictures you have recorded with [Travel Date] set. <b>Select the item with ▲/▼, and press [MENU/SET].</b> • When [All] is selected, all the pictures recorded with [Travel Date] set are played back. • When [Travel Date] or [Location] is selected, select the date or the travel destination with ▲/▼/◀/▶, and press [MENU/SET].
[Category Selection]	This mode allows you to search images by Scene Mode or other categories (such as [Portrait], [Scenery] or [Night Scenery]) and sort the pictures into each of the categories. You can then play back the pictures in each category. <b>Press ▲/▼/◀/▶ to select the category and then press [MENU/SET] to set.</b> • Only the category for which pictures have been found can be selected. 
[Favorite]	You can play back the pictures you have set as [Favorite] ( <a href="#">P149</a> ).

## ■ About the categories to be sorted

It will be sorted as following when [Category Selection] is set.

	Recording information e.g. Scene Modes
	[Face Recog.]*
	[Portrait], [i-Portrait], [Soft Skin], [Night Portrait], [i-Night Portrait], [Baby1]/[Baby2], [i-Baby]
	[Scenery], [i-Scenery], [Panorama Shot], [Sunset], [i-Sunset], [Glass Through]
	[Night Portrait], [i-Night Portrait], [Night Scenery], [i-Night Scenery], [Handheld Night Shot]
	[Sports], [Snow], [Beach & Snorkeling]
	[Baby1]/[Baby2], [i-Baby]
	[Pet]
	[Food]
	[Underwater]
	Pictures taken in [Time Lapse Shot]

- \* Press ▲/▼/◀/▶ to select the person to play back and then press [MENU/SET].  
The pictures taken in [Time Lapse Shot] are treated as Face Recognition pictures in group units.

**[Calendar]**

You can display pictures by recording date.

**1** Press **▲/▼/◀/▶** to select the date to be played back.

- If there were no pictures recorded during a month, that month is not displayed.

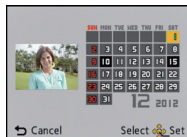

**2** Press **[MENU/SET]** to display the pictures that were recorded on the selected date.

- Press **[🗑️/↩️]** to return to the calendar screen.



**Note**

- The recording date of the picture selected in the playback screen becomes the date selected when the calendar screen is first displayed.
- If there are multiple pictures with the same recording date, the first picture recorded on that day is displayed.
- You can display the calendar between January 2000 and December 2099.
- If the date is not set in the camera, the recording date is set as the 1st January, 2012.
- If you take pictures after setting the travel destination in [World Time], the pictures are displayed by the dates at the travel destination in Calendar Playback.

## Having Fun with Recorded Pictures

### [Auto Retouch]

The brightness and colour of the pictures taken can be balanced.

- With [Auto Retouch], a new edited picture is created. Check that there is free space on the built-in memory or the card.

[Auto Retouch] cannot be used if the card's Write-Protect switch is set to [LOCK].



\* These pictures are examples to show the effect.

**1** Press **◀/▶** to select a picture, and then press **▲**.

**2** Press **[MENU/SET]**.

- Confirmation screen is displayed. It is executed when [Yes] is selected.

#### Note

- Depending on the picture, noise may be emphasised by [Auto Retouch].
- Effects may be difficult to see depending on the picture.
- It may not be possible to perform [Auto Retouch] on pictures which have already been retouched.
- [Auto Retouch] may not be performed on pictures recorded with other equipment.
- [Auto Retouch] is not possible in the following cases:
  - Motion pictures
  - Pictures taken in [Panorama Shot] in Scene Mode
  - 3D pictures

## Using the [Playback] Menu

You can setup pictures to be uploaded to image sharing sites and perform editing like cropping recorded pictures, as well as set up the protection of recorded images, etc.

- With [Text Stamp], [Resize] or [Cropping] a new edited picture is created. A new picture cannot be created if there is no free space on the built-in memory or the card so we recommend checking that there is free space and then editing the picture.

### [Upload Set]

It is possible to setup the images to be uploaded to the image sharing sites (Facebook/YouTube) on this unit.

- You can only upload motion pictures to YouTube, while you may upload both motion pictures and still pictures to Facebook.
- **This cannot be done to the images in the built-in memory. Copy the images to a card (P154), and then perform the [Upload Set].**

**1** Select [Upload Set] on the [Playback] menu. (P46)

**2** Press ▲/▼ to select [SINGLE] or [MULTI] and then press [MENU/SET].

**3** Select the picture, and then press [MENU/SET] to set.

- The setting is cancelled when [MENU/SET] is pressed again.
- Exit the menu after it is set.

#### [MULTI] setting

Press [DISP.] to set (repeat), and then press [MENU/SET] to set.

- The setting is cancelled when [DISP.] is pressed again.
- Confirmation screen is displayed. It is executed when [Yes] is selected. Exit the menu after it is executed.

[SINGLE]



Press ◀/▶ to select the picture.

[MULTI]

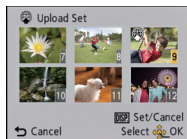

Press ▲/▼/◀/▶ to select the pictures.

### ■ Upload to the image sharing sites

An upload tool built-in to the camera "LUMIX Image Uploader" is automatically copied to the card when you setup [Upload Set].

Perform the upload operation after connecting the camera to a PC (P165). For details, refer to P168.

### ■ Cancelling all the [Upload Set] settings

**1** Select [Upload Set] on the [Playback] menu.

**2** Press ▲/▼ to select [CANCEL] and then press [MENU/SET].

- Confirmation screen is displayed. It is executed when [Yes] is selected.  
Exit the menu after it is executed.



#### Note

- Setting may not be possible for pictures recorded with other cameras.
- It cannot be set with the card less than 512 MB.

## [Title Edit]

You can add text (comments) to pictures. After text has been registered, it can be stamped in prints using [Text Stamp] (P143).

**1** Select [Title Edit] on the [Playback] menu. (P46)

**2** Press ▲/▼ to select [SINGLE] or [MULTI] and then press [MENU/SET].

**3** Select the picture, and then press [MENU/SET] to set.

- [E] is displayed for pictures with titles already registered.

## [MULTI] setting

Press [DISP.] to set (repeat), and then press [MENU/SET] to set.

- The setting is cancelled when [DISP.] is pressed again.

[SINGLE]



Press ◀/▶ to select the picture.

[MULTI]

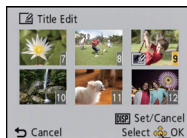

Press ▲/▼/◀/▶ to select the pictures.

**4** Enter the text. (P90)

- Exit the menu after it is set.

 **Note**

- To delete the title, erase all the text in the text input screen.
- You can print out texts (comments) using the "PHOTOfunSTUDIO" bundled software on the CD-ROM (supplied).
- You can set up to 100 pictures at one time in [MULTI].
- You cannot use [Title Edit] for the following types of pictures:
  - Motion pictures
  - 3D pictures
  - Pictures recorded with other equipment

**[Place-Name Edit]**

You can display other location names or landmark names as selectable candidates by searching the database in this unit using the location information of the picture when it was recorded. Location name information can be changed by overwriting with selected candidate information.

- 1** Select **[Place-Name Edit]** on the **[Playback]** menu. (P46)
- 2** Press **◀/▶** to select a picture with **[GPS]** icon, and then press **[MENU/SET]**.
- 3** Press **▲/▼** to select item, and then press **[MENU/SET]**.

Item	Settings
<b>[Candidate]</b>	Display other candidates by searching within the database in this unit. <b>1</b> Press <b>▲/▼</b> to select the item to change, and then press <b>[MENU/SET]</b> . <b>2</b> Select the candidate from the search result, and then press <b>[MENU/SET]</b> .
<b>[Direct]</b>	Stored location or landmark name can be changed with the text entry function. • For details on how to enter character, refer to "Entering Text" on P90.
<b>[Repeat]</b>	Copy the contents of the last performed edit into other pictures. • Confirmation screen is displayed. It is executed when [Yes] is selected. • The contents of the edit are copied to the selected pictures.

- Exit the menu after it is executed.

**Note**

- Pictures recorded using Panasonic cameras (LUMIX) with the GPS function released in or before 2010 cannot be edited.

## [Text Stamp]

You can stamp the recording date/time, name, location, travel date, the location name or landmark name stored by the GPS function, etc., onto the recorded pictures.

**1** Select [Text Stamp] on the [Playback] menu. (P46)

**2** Press ▲/▼ to select [SINGLE] or [MULTI] and then press [MENU/SET].

**3** Select the picture, and then press [MENU/SET] to set.

- is displayed on pictures already with date or text stamped.

## [MULTI] setting

Press [DISP.] to set (repeat), and then press [MENU/SET] to set.

- The setting is cancelled when [DISP.] is pressed again.

[SINGLE]



Press ◀/▶ to select the picture.

[MULTI]

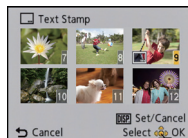

Press ▲/▼/◀/▶ to select the pictures.

**4** Press ▲/▼ to select [Set], and then press [MENU/SET].

**5** Press ▲/▼ to select text stamp items, and then press [MENU/SET].



Press ▲/▼ to select the settings, and then press [MENU/SET].

Item	Setting item
[Shooting Date]	<p>[W/O TIME]: Stamp the year, month and day.</p> <p>[WITH TIME]: Stamp the year, month, day, hour and minutes.</p> <p>[OFF]</p>
[Name]	<p>[]: ([Face Recognition]) Name registered in Face Recognition will be stamped.</p> <p>[]: ([Baby/Pet]) Stamps names registered in name settings for [Baby1]/[Baby2] or [Pet] in Scene Mode.</p> <p>[OFF]</p>
[Location]	<p>[ON]: Stamps the travel destination name set under [Location].</p> <p>[OFF]</p>
[Travel Date]	<p>[ON]: Stamps the travel date set under [Travel Date].</p> <p>[OFF]</p>
[Title]	<p>[ON]: Title input in the [Title Edit] will be stamped.</p> <p>[OFF]</p>
[Country/Region]	<p>[ON]: Stamps the Location name information or latitude/longitude recorded with GPS function.</p> <p>[OFF]</p>
[State/Prov./County]	
[County/Township]	
[City/Town/Village]	
[Landmark]	
[Longitude/Latitude]	
[Sensor Information]	<p>[ON]: Stamps the direction/altitude/atmospheric pressure information.</p> <p>[OFF]</p>

**7** Press [/↵].

**8** Press ▲ to select [OK], and then press [MENU/SET].

- Confirmation screen is displayed. It is executed when [Yes] is selected. Exit the menu after it is executed.

 **Note**

- When you print pictures stamped with text, the date will be printed over the stamped text if you specify printing of the date at the photo shop or on the printer.
- You can set up to 100 pictures at one time in [MULTI].
- The picture quality may deteriorate when text stamping is carried out.
- Depending on the printer being used, some characters may be cut at printing. Check before printing.
- When text is stamped onto the images smaller than 0.3 M, it is difficult to read it.
- The whole set of characters may not be stamped for location names or landmark names that have many characters.
- Text and dates cannot be stamped on the pictures in the following cases.
  - Motion pictures
  - Pictures taken in [Panorama Shot] in Scene Mode
  - 3D pictures
  - Pictures recorded without setting the clock and title
  - Pictures with date or text stamped
  - Pictures recorded with other equipment

## [Video Divide]

Recorded motion picture can be divided in two. It is recommended for when you want to divide a part you need with a part you do not need.

**It cannot be restored once divided.**

- 1 Select **[Video Divide]** on the **[Playback]** menu. (P46)
- 2 Press **◀/▶** to select the motion picture to divide, and then press **[MENU/SET]**.
- 3 Press **▲** at the location to divide.
  - Motion picture is played back from the same location when **▲** is pressed again.
  - You can finely adjust the location for division by pressing **◀/▶** while the motion picture is paused.
- 4 Press **▼**.
  - Confirmation screen is displayed. It is executed when **[Yes]** is selected. Exit the menu after it is executed.
  - Motion picture may be lost if the card or battery is removed while processing the dividing.



### Note

- [Video Divide] may not be performed on motion pictures recorded with other equipment.
  - Motion pictures cannot be divided at a location close to the start or end of the motion picture.
  - With [MP4] motion pictures, the order of pictures will change if divided.
- It is recommended to search these motion pictures by using [Calendar] or [Video Only] in the [Filtering Play].
- Motion pictures with a short recording time cannot be divided.

**[Resize]**

To allow easy posting to web pages, attachment to e-mail etc., picture size (number of pixels) is reduced.

**1** Select **[Resize]** on the **[Playback]** menu. **(P46)**

**2** Press **▲/▼** to select **[SINGLE]** or **[MULTI]** and then press **[MENU/SET]**.

**3** Select the picture and size.

**[SINGLE] setting**

**1** Press **◀/▶** to select the picture, and then press **[MENU/SET]**.

**2** Press **◀/▶** to select the size, and then press **[MENU/SET]**.

- Confirmation screen is displayed. It is executed when [Yes] is selected.  
Exit the menu after it is executed.

**[MULTI] setting**

**1** Press **▲/▼** to select the size, and then press **[MENU/SET]**.

**2** Press **▲/▼/◀/▶** to select the picture, and then press **[DISP.]**.

- Repeat this step for each picture, and press [MENU/SET] to set.
- Confirmation screen is displayed. It is executed when [Yes] is selected.  
Exit the menu after it is executed.

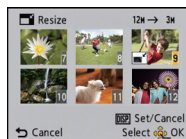
**Note**

- You can set up to 100 pictures at one time in [MULTI].
- The picture quality of the resized picture will deteriorate.
- It may not be possible to resize pictures recorded with other equipment.
- The following images cannot be resized.
  - Motion pictures
  - Pictures taken in [Panorama Shot] in Scene Mode
  - 3D pictures
  - Pictures with date or text stamped

**[Cropping]**

You can enlarge and then crop the important part of the recorded picture.

- 1** Select **[Cropping]** on the **[Playback]** menu. (P46)
- 2** Press **◀/▶** to select the picture, and then press **[MENU/SET]**.
- 3** Use the zoom button and press **▲/▼/◀/▶** to select the parts to be cropped.



Zoom button [T]: Enlargement

Zoom button [W]: Reduction

▲/▼/◀/▶: Move

- 4** Press **[MENU/SET]**.

- Confirmation screen is displayed. It is executed when [Yes] is selected. Exit the menu after it is executed.

 **Note**

- The picture quality of the cropped picture will deteriorate.
- It may not be possible to crop pictures recorded with other equipment.
- The following images cannot be cropped.
  - Motion pictures
  - Pictures taken in [Panorama Shot] in Scene Mode
  - 3D pictures
  - Group of pictures taken in [Time Lapse Shot]
  - Pictures with date or text stamped
- Information regarding the Face Recognition in the original picture will not be copied to images having undergone [Cropping].

**[Favorite]**

You can do the following if a mark has been added to pictures and they have been set as favourites.

- Play back only the pictures set as favourites. ([Favorite] in [Filtering Play])
- Play back the pictures set as favourites only as a slide show.
- Delete all the pictures not set as favourites. ([All Delete Except Favorite])

**1** Select **[Favorite]** on the **[Playback]** menu. (P46)

**2** Press **▲/▼** to select **[SINGLE]** or **[MULTI]** and then press **[MENU/SET]**.

**3** Select the picture, and then press **[MENU/SET]**.

- The setting is cancelled when [MENU/SET] is pressed again.
- Exit the menu after it is set.

[SINGLE]



Press **◀/▶** to select the picture.

[MULTI]

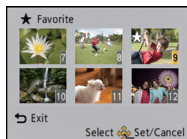

Press **▲/▼/◀/▶** to select the pictures.

### ■ Cancelling all the [Favorite] settings

**1** Select **[Favorite]** on the **[Playback]** menu.

**2** Press **▲/▼** to select **[CANCEL]** and then press **[MENU/SET]**.

- Confirmation screen is displayed. It is executed when [Yes] is selected.
- Exit the menu after it is executed.

#### Note

- You can set up to 999 pictures as favourites.
- You may not be able to set pictures taken with other equipment as favourites.

**[Print Set]**

DPOF "Digital Print Order Format" is a system that allows the user to select which pictures to print, how many copies of each picture to print and whether or not to print the recording date on the pictures when using a DPOF compatible photo printer or photo printing store. For details, ask at your photo printing store.

When you want to use a photo printing store to print pictures recorded on the built-in memory, copy them to a card (P154) and then set the print setting.

**1** Select **[Print Set]** on the **[Playback]** menu. (P46)

**2** Press **▲/▼** to select **[SINGLE]** or **[MULTI]** and then press **[MENU/SET]**.

**3** Select the picture, and then press **[MENU/SET]**.

[SINGLE]

[MULTI]

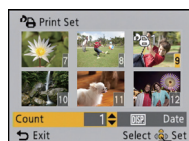

Press **◀/▶** to  
select the picture.

Press **▲/▼/◀/▶** to  
select the pictures.

**4** Press **▲/▼** to set the number of prints, and then press **[MENU/SET]** to set.

- When **[MULTI]** has been selected, repeat steps **3** and **4** for each picture. (It is not possible to use the same setting for a multiple number of pictures.)
- Exit the menu after it is set.

**■ Cancelling all the [Print Set] settings****1** Select [Print Set] on the [Playback] menu.**2** Press ▲/▼ to select [CANCEL] and then press [MENU/SET].

- Confirmation screen is displayed. It is executed when [Yes] is selected.  
Exit the menu after it is executed.

**■ To print the date**

After setting the number of prints, set/cancel printing with the recording date by pressing [DISP].

- Depending on the photo printing store or the printer, the date may not be printed even if you set to print the date. For further information, ask at your photo printing store or refer to the operating instructions for the printer.
- The date cannot be printed on pictures with date or text stamped.

**Note**

- The number of prints can be set from 0 to 999.
- Depending on the printer, the date print settings of the printer may take precedence so check if this is the case.
- It may not be possible to use the print settings with other equipment. In this case, cancel all the settings, and reset the settings.
- [Print Set] cannot be set for motion pictures.
- If the file is not based on the DCF standard, the print setting cannot be set.

**[Protect]**

You can set protection for pictures you do not want to be deleted by mistake.

- 1** Select **[Protect]** on the **[Playback]** menu. (P46)
- 2** Press **▲/▼** to select **[SINGLE]** or **[MULTI]** and then press **[MENU/SET]**.
- 3** Select the picture, and then press **[MENU/SET]**.

- The settings are cancelled when **[MENU/SET]** is pressed again.
- Exit the menu after it is set.



Press **◀/▶** to  
select the picture.

Press **▲/▼/◀/▶** to  
select the pictures.

### ■ Cancelling all the **[Protect]** settings

- 1** Select **[Protect]** on the **[Playback]** menu.
- 2** Press **▲/▼** to select **[CANCEL]** and then press **[MENU/SET]**.
  - Confirmation screen is displayed. It is executed when **[Yes]** is selected.
  - Exit the menu after it is executed.

#### **Note**

- The protect setting may not be effective on other equipment.
- Even if you protect pictures in the built-in memory or a card, they will be deleted if the built-in memory or the card is formatted.
- Even if you do not protect pictures on a card, they cannot be deleted when the card's Write-Protect switch is set to **[LOCK]**.

**[Face Rec Edit]**

You can delete or change the information relating to Face Recognition for the selected picture.

- 1** Select **[Face Rec Edit]** on the **[Playback]** menu. (P46)
- 2** Press **▲/▼** to select **[REPLACE]** or **[DELETE]** and then press **[MENU/SET]**.
- 3** Press **◀/▶** to select the picture and then press **[MENU/SET]**.
- 4** Press **◀/▶** to select the person and then press **[MENU/SET]**.



- 5** (When **[REPLACE]** is selected) Press **▲/▼/◀/▶** to select the person to replace and then press **[MENU/SET]**.

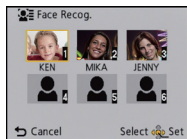

- Confirmation screen is displayed. It is executed when [Yes] is selected.  
Exit the menu after it is executed.

**Note**

- Cleared information regarding the [Face Recog.] cannot be restored.
- When all Face Recognition information in a picture has been cancelled, the picture will not be categorised using Face Recognition in [Category Selection] in [Filtering Play].
- You cannot edit the Face Recognition information of protected pictures.

**[Copy]**

You can copy the data of the pictures you have taken from the built-in memory to a card or from a card to the built-in memory.

**1** Select **[Copy]** on the **[Playback]** menu. (P46)

**2** Press **▲/▼** to select the copy destination and then press **[MENU/SET]**.

**[IN→SD]**:  
([IN→SD])

All the picture data in the built-in memory are copied onto the card at one time.

**[SD→IN]**:  
([SD→IN])

One picture at a time is copied from the card to the built-in memory.  
Press **◀/▶** to select the picture and then press **[MENU/SET]**.

- Confirmation screen is displayed. It is executed when [Yes] is selected. Exit the menu after it is executed.
- Do not turn the camera off at any point during the copying process.

 **Note**

- If a picture exists with the same name (folder number/file number) as the picture to be copied in the copy destination when **[IN→SD]** is selected, a new folder is created and the picture is copied. If a picture exists with the same name (folder number/file number) as the picture to be copied in the copy destination when **[SD→IN]** is selected, that picture is not copied.
- It may take time to copy the picture data.
- [Print Set], [Protect] or [Favorite] settings will not be copied. Perform the settings again after copying is finished.
- Motion picture recorded in [AVCHD] cannot be copied.

## Playing Back Pictures on a TV Screen

Pictures recorded with this unit can be played back on a TV screen.

Preparations: Turn this unit and the TV off.

**Confirm the terminals on your TV and use a cable compatible with the terminals. Image quality may vary with the connected terminals.**

- ① High quality
- ② HDMI socket
- ③ Video socket

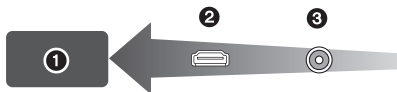

### 1 Connect the camera and a TV.

- Check the direction of the terminals and plug in/out straight holding onto the plug. (It may result in malfunction by the deforming of the terminal if it is plugged in obliquely or in wrong direction.) Do not connect devices to incorrect terminals. Doing so may cause malfunction.

#### To connect with an AV cable (supplied)

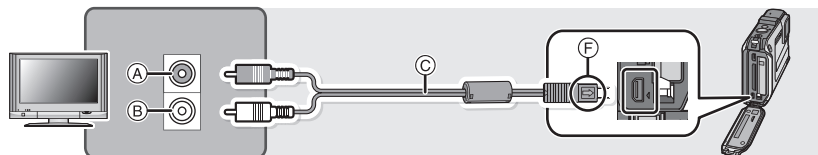

- Do not use any other AV cables except the supplied one.
- Check the [TV Aspect]. (P58)

#### To connect with an HDMI micro cable (optional)

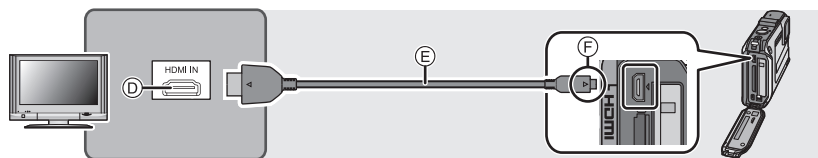

- Always use a genuine Panasonic HDMI micro cable (RP-CHEU15: optional). Part number: RP-CHEU15 (1.5 m) (5 feet)
- Pictures are not displayed on the LCD monitor.
- Some playback functions are restricted.
- [Playback] menu, [GPS/Sensor] menu and [Setup] menu cannot be used.
- For more details about VIERA Link (HDMI) playback, refer to P157.

- (A) Yellow: to the video input socket
- (B) White: to the audio input socket
- (C) AV cable (supplied)
- (D) HDMI socket
- (E) HDMI micro cable (optional)
- (F) Align the marks, and insert.

**2** Turn on the TV and select the input to match the terminal in use.

**3** Turn the camera on and then press **[▶]**.

**Note**

- Depending on the [Aspect Ratio], black bands may be displayed on the top and bottom or the left and right of the pictures.
- Change the screen mode on your TV if the picture is displayed with the top or bottom cut off.
- Output from the HDMI micro cable has priority when both AV cable and HDMI micro cable are connected.
- The connection with the USB connection cable will take priority when you connect the USB connection cable simultaneously with the HDMI micro cable.
- When you play back a picture vertically, it may be blurry.
- When pictures are displayed, they may not be displayed properly depending on the type of TV.
- You can view pictures on TVs in other countries (regions) which use the NTSC or PAL system when you set [Video Out] in the [Setup] menu.
- Audio will be played back as monaural.
- Environment information such as direction, altitude (water depth) and atmospheric pressure is not displayed.
- No sound is output from the camera speakers.
- Read the operating instructions for the TV.
- Before removing a battery, turn the camera off and disconnect the AV cable or HDMI micro cable.

The recorded still pictures can be played back on a TV with an SD Memory Card slot.

- Depending on the TV model, pictures may not be displayed on the full screen.
- Motion pictures recorded with [AVCHD] can be played back on Panasonic TVs (VIERA) with the AVCHD logo mark.
- In some cases, panorama pictures cannot be played back. Also, auto-scroll playback of panorama pictures may not work.
- For cards compatible with playback, refer to the operating instructions of the TV.

## Using VIERA Link (HDMI)

### What is the VIERA Link (HDMI) (HDAVI Control™)?

- This function allows you to use your remote control for the Panasonic TV for easy operations when this unit has been connected to a VIERA Link compatible device using an HDMI micro cable (optional) for automatic linked operations. (Not all operations are possible.)
- VIERA Link is a unique Panasonic function built on an HDMI control function using the standard HDMI CEC (Consumer Electronics Control) specification. Linked operations with HDMI CEC compatible devices made by other companies are not guaranteed. When using devices made by other companies that are compatible with VIERA Link, refer to the operating instructions for the respective devices.
- This unit is compatible with VIERA Link Ver.5. VIERA Link Ver.5 is the newest Panasonic version and is also compatible with existing Panasonic VIERA Link devices. (As of November 2011)

Preparations: Set the [VIERA Link] to [ON]. (P59)

- 1** Connect this unit to a Panasonic TV compatible with VIERA Link with an HDMI micro cable (optional). (P155)
- 2** Turn the camera on and then press .
- 3** Operate with the remote control for the TV.
  - Operate with reference to the operation icons displayed on the screen.

#### Note

- To play back the audio of the motion pictures, set the [Sound] in the Slide Show setting screen to [AUTO] or [Audio].
- It is recommended to connect this unit to an HDMI terminal other than the HDMI1 if there are 2 or more HDMI input terminals on the TV.
- Operation using the button on this unit will be limited.

## ■ Other linked operations

### Turning the power off:

If you use the remote control for the TV to turn off the power, the power on this unit also turns off.

### Automatic input switching:

- If you connect with an HDMI micro cable and then turn on the power on this unit, and then press [▶], the input channel on the TV automatically switches to this unit's screen. If the TV's power is in standby status, it will turn on automatically (if [Set] has been selected for the TV's [Power on link] setting).
- Depending on the HDMI terminal on the TV, the input channel may not switch automatically. In this case, use the remote control for the TV to switch the input channel. (For details on how to switch input, please read the operating instructions for the TV.)
- If VIERA Link does not work properly, refer to [P201](#).

### Note

- If you are unsure whether or not the TV you are using are compatible with VIERA Link, read the operating instructions for the TV.
- Available linked operations between this unit and a Panasonic TV is different depending on the types of Panasonic TVs even if they are compatible with VIERA Link. Refer to the operating instructions of the TV for the operations that support on the TV.
- Operation is not possible with a cable that is not based on the HDMI standard. Always use a genuine Panasonic HDMI micro cable (RP-CHEU15: optional).  
Part number: RP-CHEU15 (1.5 m) (5 feet)

## Playing back 3D pictures

Connecting the camera to a 3D compatible television and playing back pictures taken in 3D allows you to enjoy 3D pictures for extra impact.

It is also possible to play back the recorded 3D pictures by inserting an SD card into the 3D compatible television with an SD card slot.

**For current information regarding devices that can play back 3D pictures recorded with this unit, please refer to the below support site.**

<http://panasonic.jp/support/global/cs/dsc/> (This site is English only.)

Preparations: Set [3D Playback] (P59) to [3D].

### Connect the unit to a 3D compatible television using the HDMI micro cable and display the playback screen. (P155)

- When [VIERA Link] (P59) is set to [ON] and the camera is connected to a TV supporting VIERA Link, input of the TV will be switched automatically and playback screen will be displayed. Refer to P157 for details.
- For the pictures recorded in 3D, [3D] will appear on the thumbnail display at playback.

#### ■ Play back as a 3D slide show by selecting only the still pictures recorded in 3D

Select [3D Play] in [Slide Show] in the Playback Mode. (P133)

#### ■ Play back in 3D by selecting only the still pictures recorded in 3D

Select [3D Play] in [Filtering Play] in the Playback Mode. (P135)

#### ■ Switch the playback method for the still pictures recorded in 3D

**1** Select the picture recorded in 3D.

**2** Select [2D/3D Settings] on the Playback Mode and then press [MENU/SET]. (P132)

- Playback method will switch to 3D if it is playing back in 2D (conventional image).
- If you feel tired, uncomfortable or otherwise strange when playing back pictures recorded in 3D, set to 2D.

 **Note**

- When the picture is not appropriate to view in 3D (disparity is too large, etc.)
  - [Slide Show]:  
The picture will be played back in 2D.
  - [Filtering Play]:  
Confirmation screen is displayed. Select whether or not to play back the picture in 3D.
- 2 pictures may be displayed side by side when a 3D picture is played back on a TV that is not 3D compatible.
- When a picture recorded in 3D is displayed on the LCD monitor of this unit, it is played back in 2D (conventional image).
- A black screen is displayed for a few seconds when switching back and forth playback of 3D pictures and 2D pictures.
- When you select a 3D picture thumbnail, it may take a few seconds for playback to start. After playback, the thumbnail display may take a few seconds to reappear.
- When viewing 3D pictures, your eyes may become tired if you are too close to the television screen.
- If your television does not switch to a 3D picture, make the necessary settings on the TV. (For details, refer to the operating instructions of the TV.)
- Pictures cannot be deleted when 3D pictures are being played back. The [Setup] menu, [GPS/Sensor] menu, [Playback] menu and Playback zoom functions cannot be used.
- 3D pictures can be saved to your computer or Panasonic devices. (P161)

## Saving the Recorded Still Pictures and Motion Pictures

Methods to export still pictures and motion pictures to other devices will vary depending on the file format (JPEG, MPO, AVCHD, or MP4). Here are a few suggestions.

### Copy by inserting the SD card into the recorder

**Panasonic devices compatible with the respective file format (such as a Blu-ray Disc recorder) can be used to copy the images.**

For details on compatible devices, refer to the support sites below.

<http://panasonic.jp/support/global/cs/dsc/>

(This Site is English only.)

\* Some compatible devices may not be sold in certain countries and regions.

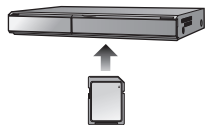

- See the operating instructions for the recorder about the details about copying and playing back.

## Copy the playback image using an AV cable

Copy images played back with this unit to Blu-ray disc, DVD disc, hard disk, or video using a Blu-ray Disc Recorder, DVD recorder, or video.

This can be played back with equipment that is not compatible with high definition, so it is convenient for distributing copies. Image will be standard quality instead of high definition at this time.

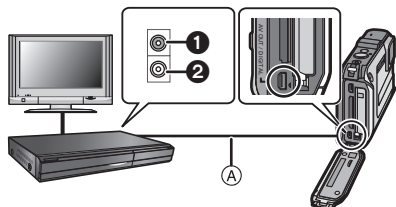

- ① Yellow: to the video input socket
- ② White: to the audio input socket
- Ⓐ AV cable (supplied)

- 1** Connect this unit with the recording equipment with an AV cable (supplied).
- 2** Start the playback of this unit.
- 3** Start the recording on the recording equipment.

- When ending the recording (copying), stop the playback on this unit after stopping the recording in recording equipment.

### Note

- When you play back motion pictures on 4:3 aspect ratio TV, you must set [TV Aspect] (P58) on this unit to [4:3] before starting a copy. The image will appear vertically long if you play back motion pictures copied with [16:9] setting on a [4:3] aspect TV.
- It is recommended to turn off the display of the screen by pressing the [DISP.] on the camera while copying. (P61)
- See the instruction manual for the recording equipment about the details of copying and playing back.

## Copying to a PC using "PHOTOfunSTUDIO"

The software "PHOTOfunSTUDIO" on the CD-ROM (supplied) can be used to save all the still pictures and motion pictures recorded by the camera in their various formats to your computer.



### 1 Install "PHOTOfunSTUDIO" to the PC.

- Read the separate "Basic Operating Instructions" for more information about the software in the CD-ROM (supplied) and how to install it.

### 2 Connect camera to PC.

- For details on how to connect the camera, refer to "Acquiring of still pictures and [MP4] motion pictures (other than [AVCHD] motion pictures)" (P165).

### 3 Copy the images to a PC using "PHOTOfunSTUDIO".

- For details, refer to the operating instructions of "PHOTOfunSTUDIO" (PDF).



#### Note

- Do not delete or move imported files or folders in Windows Explorer. When viewing in "PHOTOfunSTUDIO", you will not be able to play back or edit.

## Connecting to a PC

You can transfer the pictures in the camera to a PC by connecting the camera and the PC.

- Some PCs can read directly from the card removed from the camera. For details, refer to the operating instructions of your PC.
- **If the computer being used does not support SDXC Memory Cards, a message prompting you to format may appear. (Doing so will cause recorded images to be erased so do not choose to format.)**

**If the card is not recognised, please refer to the below support site.**

**<http://panasonic.net/avc/sdcard/information/SDXC.html>**

- You can easily print out or mail the pictures you have imported. Use of the "PHOTOfunSTUDIO" bundled software on the CD-ROM (supplied) is a convenient way of doing this.
- Read the separate "Basic Operating Instructions" for more information about the software in the CD-ROM (supplied) and how to install it.

### ■ PC that can be used

The unit can be connected to any PC capable of recognizing a mass storage device.

- Windows support:                    Windows 7/Windows Vista/Windows XP/Windows 2000/  
   Windows Me
- Mac support:                            OS X v10.1 ~ v10.7

AVCHD motion pictures may not be imported correctly when copied as files or folder.

- With Windows, always import AVCHD motion pictures using "PHOTOfunSTUDIO", one of the programmes on the CD-ROM (supplied).
- With a Mac, AVCHD motion pictures can be imported using "iMovie'11".  
(For details about iMovie'11, please contact Apple Inc.)

## Acquiring of still pictures and [MP4] motion pictures (other than [AVCHD] motion pictures)

### Preparations:

Turn on the camera and the PC.

Remove the card before using the pictures in the built-in memory.

### 1 Connect the computer and camera with the USB connection cable (supplied).

- Check the directions of the connectors, and plug them straight in or unplug them straight out. (Otherwise the connectors may bend out of shape which will cause a malfunction.) Do not connect devices to incorrect terminals. Doing so may cause malfunction.
- Do not use any other USB connection cables except the supplied one. Use of cables other than the supplied USB connection cable may cause malfunction.

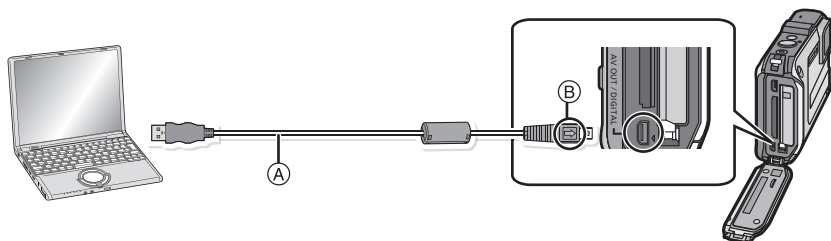

(A) USB connection cable (supplied)

(B) Align the marks, and insert.

### 2 Press ▲/▼ to select [PC], and then press [MENU/SET].

- If [USB Mode] (P58) is set to [PC] in the [Setup] menu in advance, the camera will be automatically connected to the PC without displaying the [USB Mode] selection screen.
- When the camera has been connected to the PC with [USB Mode] set to [PictBridge(PTP)], a message may appear on the PC's screen. Close the screen by selecting [Cancel], safely remove the USB connection cable (P167), and set the [USB Mode] to [PC].

### 3 Operate the PC.

- You can save the images into the PC by drag and drop the image or the folder with the image you would like to transfer onto the different folder in the PC.

#### Note

- Use a battery with sufficient battery power or the AC adaptor (optional). If the remaining battery power becomes low while the camera and the PC are communicating, the alarm beeps. Refer to "Disconnecting the USB connection cable safely" (P167) before disconnecting the USB connection cable. Otherwise, data may be destroyed.
- Before connecting or disconnecting the AC adaptor (optional), turn the camera off.
- Before inserting or removing a card/battery, turn the camera off and disconnect the USB connection cable. Otherwise, data may be destroyed.

## ■ Viewing the contents of the built-in memory or card using the PC (folder composition)

**For Windows:** A drive ([Removable Disk]) is displayed in [Computer]

**For Mac:** A drive ([LUMIX], [NO\_NAME] or [Untitled]) is displayed on the desktop

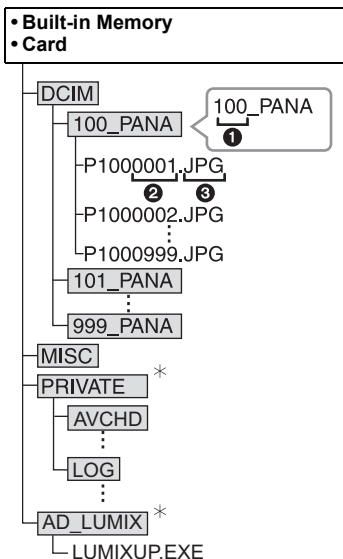

DCIM:	Images
①	Folder number
②	File number
③	JPG:
	Still pictures
	MP4:
	[MP4] Motion pictures
	MPO:
	3D pictures
MISC:	DPOF print
	Favourite
AVCHD:	[AVCHD] Motion pictures
LOG:	Altimeter log
AD_LUMIX:	For Upload set
LUMIXUP.EXE:	Upload tool
	"LUMIX Image Uploader"

\* Cannot be created in the built-in memory.

A new folder is created when pictures are taken in the following situations.

- After [No.Reset] (P57) in the [Setup] menu has been executed
- When a card containing a folder with the same folder number has been inserted (Such as when pictures were taken using another maker of camera)
- When there is a picture with file number 999 inside the folder

## ■ Disconnecting the USB connection cable safely

Select the [] icon in task tray displayed on the PC, and then click [Eject DMC-XXX] (XXX varies by model).

- Depending on your PC's settings, this icon may not be displayed.
- If the icon is not displayed, check that [Access] is not displayed on the LCD monitor of the digital camera before removing the hardware.

## ■ Connection in the PTP Mode (Windows® XP, Windows Vista®, Windows® 7 and Mac OS X only)

Set [USB Mode] to [PictBridge(PTP)].

- Data can now be read only from the card into the PC.
- When there are 1000 or more pictures on a card, the pictures may not be imported in the PTP Mode.
- Motion picture cannot be played back in PTP Mode.

## Uploading the images to sharing sites

Still pictures and motion pictures can be uploaded to image sharing sites (Facebook/YouTube) using the upload tool “LUMIX Image Uploader”.

You do not need to transfer the images to the PC or install dedicated software onto the PC, so you can easily upload the images even away from your home or work if there is a PC that is connected to the network.

- It is only compatible with a PC with Windows XP/Windows Vista/Windows 7.
- For details, refer to the operating instructions of “LUMIX Image Uploader” (PDF).

Preparations:

Setup the images to upload with [Upload Set] (P139).

Connect the PC to the Internet.

Create an account at the image sharing site to be used, and prepare the login information.

### 1 Startup the “LUMIXUP.EXE” by double-clicking it. (P166)

- An upload tool “LUMIX Image Uploader” may startup automatically if the “PHOTOfunSTUDIO” software on the CD-ROM (supplied) is installed.

### 2 Select the destination to upload.

- Operate following the instructions displayed on the PC screen.



#### Note

- Operation cannot be guaranteed for future specification changes of the YouTube and Facebook services. Service contents or screen may be modified without notice. (This service is as of December 1st, 2011)
- Do not upload any images protected by copyright, unless you own the copyright yourself, or have permission from the relevant copyright holder.
- **Images may contain personal information that can be used to identify the user, such as a title, the time and date when the images were taken, and the location where the image was taken if the camera includes a GPS function. Check this information before uploading images to image sharing sites.**

## Printing the Pictures

If you connect the camera to a printer supporting PictBridge, you can select the pictures to be printed out and instruct that printing be started from the camera's LCD monitor.

- Some printers can print directly from the card removed from the camera. For details, refer to the operating instructions of your printer.

Preparations:

Turn on the camera and the printer.

Remove the card before printing the pictures in the built-in memory.

Check print quality and other settings on the printer before printing the pictures.

### 1 Connect the printer and camera with the USB connection cable (supplied).

- Check the directions of the connectors, and plug them straight in or unplug them straight out. (Otherwise the connectors may bend out of shape which will cause a malfunction.) Do not connect devices to incorrect terminals. Doing so may cause malfunction.
- Do not use any other USB connection cables except the supplied one.  
Use of cables other than the supplied USB connection cable may cause malfunction.

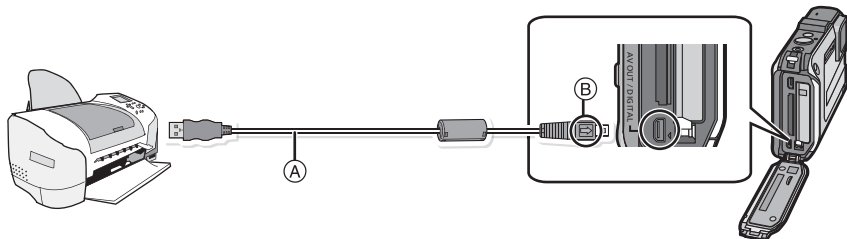

- Ⓐ USB connection cable (supplied)  
Ⓑ Align the marks, and insert.

### 2 Press ▲/▼ to select [PictBridge(PTP)], and then press [MENU/SET].

#### Note

- Use a battery with sufficient battery power or the AC adaptor (optional). If the remaining battery power becomes low while the camera and the printer are connected, the status indicator blinks and the alarm beeps. If this happens during printing, stop printing at once. If not printing, disconnect the USB connection cable.
- Do not disconnect the USB cable while [ ] (Cable disconnect prohibit icon) is displayed. (May not be displayed depending on the type of printer used)
- Before connecting or disconnecting the AC adaptor (optional), turn the camera off.
- Before inserting or removing a card/battery, turn the camera off, and disconnect the USB connection cable.
- Motion pictures cannot be printed out.

## Selecting a single picture and printing it

- 1 Press **◀/▶** to select the picture and then press **[MENU/SET]**.



- 2 Press **▲** to select **[Print start]** and then press **[MENU/SET]**.

- Refer to [P171](#) for the items which can be set before starting to print the pictures.
- Disconnect the USB connection cable after printing.

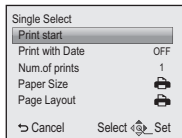

## Selecting multiple pictures and printing them

- 1 Press **▲**.

- 2 Press **▲/▼** to select an item and then press **[MENU/SET]**.

Item	Description of settings
<b>[Multi Select]</b>	Multiple pictures are printed at one time. • Press <b>▲/▼/◀/▶</b> to select the pictures, and then press <b>[DISP.]</b> . (When <b>[DISP.]</b> is pressed again, the setting is cancelled.) • After the pictures have been selected, press <b>[MENU/SET]</b> .
<b>[Select All]</b>	Prints all the stored pictures.
<b>[Print Set (DPOF)]</b>	Prints the pictures set in <b>[Print Set]</b> only. ( <a href="#">P150</a> )
<b>[Favorite]</b>	Prints the pictures set as favourites only. ( <a href="#">P149</a> )

- 3 Press **▲** to select **[Print start]** and then press **[MENU/SET]**.

- If the print check screen has appeared, select **[Yes]**, and print the pictures.
- Refer to [P171](#) for the items which can be set before starting to print the pictures.
- Disconnect the USB connection cable after printing.

## Print Settings

Select and set the items both on the screen in step 2 of the “Selecting a single picture and printing it” and in step 3 of the “Selecting multiple pictures and printing them” procedures.

- When you want to print pictures in a paper size or a layout which is not supported by the camera, set [Paper Size] or [Page Layout] to  and then set the paper size or the layout on the printer. (For details, refer to the operating instructions of the printer.)
- When [Print Set (DPOF)] has been selected, the [Print with Date] and [Num.of prints] items are not displayed.

### [Print with Date]

Item	Description of settings
[ON]	Date is printed.
[OFF]	Date is not printed.

- If the printer does not support date printing, the date cannot be printed on the picture.
- Depending on the printer, the date print settings of the printer may take precedence so check if this is the case.
- When printing images with [Date Stamp] or [Text Stamp], please remember to set [Print with Date] to [OFF] or the date will print on top.



#### Note

**When asking the photo shop to print the pictures**

- By stamping the date using [Date Stamp] (P110) or [Text Stamp] (P143) or setting date printing at the time of the [Print Set] (P150) setting before going to a photo shop, the dates can be printed at the photo shop.

### [Num.of prints]





You can set the number of prints up to 999.

**[Paper Size]**

Item	Description of settings
	Settings on the printer are prioritised.
[L/3.5"×5"]	89 mm×127 mm
[2L/5"×7"]	127 mm×178 mm
[POSTCARD]	100 mm×148 mm
[16:9]	101.6 mm×180.6 mm
[A4]	210 mm×297 mm
[A3]	297 mm×420 mm
[10×15cm]	100 mm×150 mm
[4"×6"]	101.6 mm×152.4 mm
[8"×10"]	203.2 mm×254 mm
[LETTER]	216 mm×279.4 mm
[CARD SIZE]	54 mm×85.6 mm

• Paper sizes not supported by the printer will not be displayed.

**[Page Layout] (Layouts for printing that can be set with this unit)**

Item	Description of settings
	Settings on the printer are prioritised.
	1 picture with no frame on 1 page
	1 picture with a frame on 1 page
	2 pictures on 1 page
	4 pictures on 1 page

- An item cannot be selected if the printer does not support the page layout.

**■ Layout printing****When printing a picture several times on 1 sheet of paper**

For example, if you want to print the same picture 4 times on 1 sheet of paper, set [Page Layout] to  and then set [Num.of prints] to 4 for the picture that you want to print.

**When printing different pictures on 1 sheet of paper**

For example, if you want to print 4 different pictures on 1 sheet of paper, set [Page Layout] to  and then set [Num.of prints] to 1 for each of the 4 pictures.

**Note**

- The camera is receiving an error message from the printer when the  indication lights orange during printing. After finishing printing, make sure there are no problems with the printer.
- If the number of prints is high, the pictures may be printed several times. In this case, the remaining number of prints indicated may differ from the number set.

# Screen Display

## ■ In recording

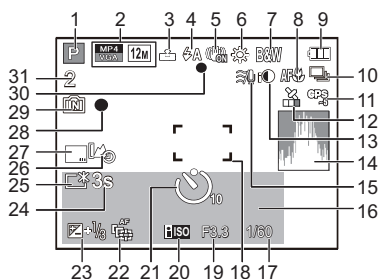

- 1 Recording Mode
- 2 Recording Mode (for recording motion pictures) (P111)  
Recording Quality (P112)  
Picture size (P92)  
☒: Backlight Compensation (P36)
- 3 Quality (P93)
- 4 Flash Mode (P65)  
☒: LED light (P55)
- 5 Optical Image Stabiliser (P109)  
||☒||: Jitter alert (P29)
- 6 White Balance (P95)
- 7 Colour Mode (P108)  
☒: Motion Deblur (P37)
- 8 AF Macro Mode (P68)  
☒: Macro Zoom Mode (P68)
- 9 Battery indication (P18)
- 10 Burst (P103)  
☒: Auto Bracket (P71)
- 11 GPS (P116)
- 12 Icon indicating positioning status (P116)
- 13 Intelligent Exposure (P100)
- 14 Histogram (P54)
- 15 Wind Cut (P113)

- 16 Number of days that have passed since the departure date (P51)  
Location (P51)  
Name (P83)  
Age (P83)  
Current date and time  
Location name information (P116, 117)  
✈: World Time (P50)  
Zoom (P63): EZWI [ ] T 1X
  - 17 Shutter speed (P32)  
M:1: Minimum shutter speed (P101)
  - 18 AF area (P33)  
☒: Spot AF area (P98)
  - 19 Aperture value (P32)
  - 20 ISO sensitivity (P94)
  - 21 Self-timer Mode (P69)  
☒: Time Lapse Shot (P105)
  - 22 AF Tracking (P99)  
AF\*: AF assist lamp (P108)
  - 23 Exposure Compensation (P70)
  - 24 Elapsed recording time (P38): 8m30s\*
  - 25 LCD Mode (P53)  
☒: LCD power save (P56)
  - 26 Altimeter log (P125)
  - 27 Date Stamp (P110)
  - 28 Recording state
  - 29 Built-in memory (P23)  
☒: Card (P23) (displayed only during recording)
  - 30 Focus (P33)
  - 31 Number of recordable pictures (P25)  
Available recording time (P26, 38): R8m30s\*
- \* "h" is an abbreviation for hour, "m" for minute and "s" for second.

## ■ In playback

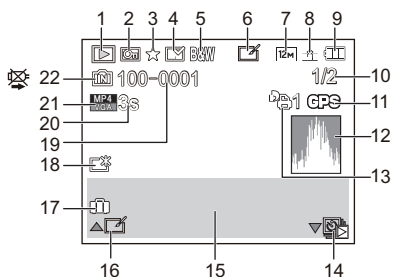

- 1 Playback Mode (P132)
- 2 Protected picture (P152)
- 3 Favourites (P149)
- 4 Date/Text stamped display (P110, 143)
- 5 Colour Mode (P108)
- 6 After Auto Retouch (P138)
- 7 Picture size (P92)
- 8 Quality (P93)
- 9 Battery indication (P18)
- 10 Picture number  
Total pictures  
Elapsed playback time (P42): 8m30s \*1
- 11 GPS (P117)
- 12 Histogram (P54)
- 13 Number of prints (P150)
- 14 Playback in the group of the pictures taken in [Time Lapse Shot] (P107)
- 15 Location (P51)  
Recording information (P62)  
Name (P83, 88)  
Age \*2 (P83, 88)  
Title (P141)  
Location name information (P116, 117)

- 16 Auto Retouch (P138)  
Motion picture playback (P42)  
Play panorama (P81)  
Continuously playback in the group of the pictures taken in [Time Lapse Shot] (P107)
- 17 Number of days that have passed since the departure date (P51)  
Recorded date and time  
✈: World Time (P50)
- 18 Power LCD (P53)  
📷: LCD power save (P56)
- 19 Folder/File number (P166)
- 20 Motion picture recording time (P42): 8m30s \*1
- 21 Recording Quality (P112)  
📷: Group of pictures taken in [Time Lapse Shot] (P107)
- 22 Built-in memory (P23)  
Cable disconnection warning icon (P169)

\*1 "h" is an abbreviation for hour, "m" for minute and "s" for second.

\*2 It is not displayed when the location name information or the number of days that have passed since the departure date is displayed.

## Cautions for Use

### **(Important) About the waterproof/dustproof and anti-shock performance of the camera**

- This camera has a waterproof/dustproof function equivalent to “IP68”. It is possible to take pictures in 12 m (40 feet) depth for 60 minutes.\*  
(This means that the camera can be used underwater for specified time in specified pressure in accordance with the handling method established by Panasonic.)
- The camera has cleared a drop test from a height of 2 m (6.6 feet) onto 3 cm (0.1 feet) thick plywood, which is compliant with “MIL-STD 810F Method 516.5-Shock”.\*
  - \* This does not guarantee no destruction, no malfunction, or waterproofing in all conditions.
- Waterproofing is not guaranteed if the unit is subject to an impact as a result of being hit or dropped etc. If an impact to the camera occurs, it should be inspected (subject to a fee) by a Panasonic’s Service Centre to verify that the waterproofing is still effective.
- Using the camera in environments where splashing with hot spring water, oil or alcohol is likely to occur may cause the water/dust resistance and impact resistance of the camera to deteriorate.
- Malfunction caused by exposure to water due to mishandling by the customer will not be covered by the warranty.
- Supplied accessories are not waterproof (excluding hand strap).

**For more detail, refer to “(Important) About the Waterproof/Dustproof and Anti-shock Performance of the Camera” (P8).**

**When using in a cold climate or at low temperatures**

- **It may cause injury to the skin if you directly touch the metal parts of the unit in places where temperature is very low [environments under 0 °C (32 °F), such as ski resorts or places at high altitude] for a long period of time. Use gloves or similar when using it for long periods.**
- The performance of the battery (number of recordable pictures/operating time) may decrease temporarily when using in a temperature between -10 °C and 0 °C (14 °F and 32 °F) (cold places such as ski resorts or places at high altitude).
- The battery cannot be recharged in a temperature less than 0 °C (32 °F). (The [CHARGE] indicator blinks when the battery cannot be recharged.)
- If the camera gets very cold in cold places such as ski resorts or places at high altitude, performance of the LCD monitor may temporarily drop immediately after turning the power on, e.g. the picture on the LCD monitor being slightly darker than usual or ghost images appearing. In cold environments, keep the camera warm during use by keeping it inside your cold-weather gear or clothes. The performance will resume as normal when the internal temperature rises.
- If the camera is used in cold places such as ski resorts or places at high altitude with snow or water droplets adhered to the camera, some parts of the camera may become hard to move or the sound may become dim with snow or water droplets freezing in the gap of the zoom button, the camera [ON/OFF] button, speakers, and microphone. This is not a malfunction.

**Optimal use of the camera**

**Keep this unit as far away as possible from electromagnetic equipment (such as microwave ovens, TVs, video games etc.).**

- If you use this unit on top of or near a TV, the pictures and/or sound on this unit may be disrupted by electromagnetic wave radiation.
- Do not use this unit near cell phones because doing so may result in noise adversely affecting the pictures and/or sound.
- Recorded data may be damaged, or pictures may be distorted, by strong magnetic fields created by speakers or large motors.
- Electromagnetic wave radiation generated by microprocessors may adversely affect this unit, disturbing the pictures and/or sound.
- If this unit is adversely affected by electromagnetic equipment and stops functioning properly, turn this unit off and remove the battery or disconnect AC adaptor (optional). Then reinsert the battery or reconnect AC adaptor and turn this unit on.

**Do not use this unit near radio transmitters or high-voltage lines.**

- If you record near radio transmitters or high-voltage lines, the recorded pictures and/or sound may be adversely affected.

**Always use the supplied cords and cables. If you use optional accessories, use the cords and the cables supplied with them.**

**Do not extend the cords or the cables.**

**Do not spray the camera with insecticides or volatile chemicals.**

- If the camera is sprayed with such chemicals, the body of the camera may be damaged and the surface finish may peel off.
- Do not keep rubber or plastic products in contact with the camera for a long period of time.

**Operation of this unit is tested up to  $-10^{\circ}\text{C}$  ( $14^{\circ}\text{F}$ ), but be aware that some parts of the camera may become hard to move when the zoom button or the camera [ON/OFF] button gets frozen etc., or the side door may become hard to open in cold places such as ski resorts or places at high altitude where the temperature may drop very rapidly.**

- When the camera is used in a cold places such as ski resorts or places at high altitude, keep the camera warm by placing it in a warm place such as inside your cold protection gear or clothing.

## Cleaning

**Before cleaning the camera, remove the battery or the DC coupler (optional), or disconnect the power plug from the outlet. Then wipe the camera with a soft, dry cloth.**

- When the camera is soiled badly, it can be cleaned by wiping the dirt off with a wrung wet cloth, and then with a dry cloth.
- Do not use solvents such as benzine, thinner, alcohol, cleanser, kitchen detergents, etc., to clean the camera, since it may deteriorate the external case or the coating may peel off.
- When using a chemical cloth, be sure to follow the accompanying instructions.
- When salt etc., has adhered to the camera, the arm part of the side door etc., may whiten. Use damp cotton swabs or similar to wipe until the whitened part is removed. Brush off lightly with the supplied brush after wiping.

Ⓐ Arm part

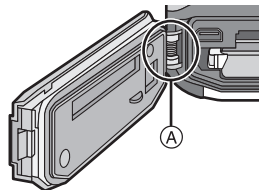

## About the LCD Monitor

- Do not press the LCD monitor with excessive force. Uneven colours may appear on the LCD monitor and it may malfunction.
- If the camera gets very cold in cold places such as ski resorts or places at high altitude, performance of the LCD monitor may temporarily drop immediately after turning the power on, e.g. the picture on the LCD monitor being slightly darker than usual or ghost images appearing. Keep the camera warm when using in a cold environment. The performance will resume as normal when the internal temperature rises.

Extremely high precision technology is employed to produce the LCD monitor screen. However, there may be some dark or bright spots (red, blue or green) on the screen. This is not a malfunction. The LCD monitor screen has more than 99.99% effective pixels with a mere 0.01% of the pixels inactive or always lit. The spots will not be recorded on pictures on the built-in memory or a card.

**About the lens, the microphone, and the speaker**

- Do not press the lens with excessive force.
- Do not leave the camera with the lens facing the sun as rays of light from the sun may cause it to malfunction. Also, be careful when placing the camera outside or near a window.
- If there is water or dirt on the lens, wipe it off with dry soft cloth before taking a picture.
- A sound might be muffled or warped when there is water on the microphone or the speaker. Wipe the residues after letting the water drip out from the microphone and speaker by tipping the camera downward, and use it after letting it dry for a while.
- Do not poke the holes of microphone and speaker with sharp points. (It may damage the waterproof sheet inside, which may damage the waterproof performance.)

**Battery**

**The battery is a rechargeable lithium ion battery. Its ability to generate power comes from the chemical reaction that takes place inside it. This reaction is susceptible to the surrounding temperature and humidity. If the temperature is too high or too low, the operating time of the battery will become shorter.**

**Always remove the battery after use.**

- Place the removed battery in a plastic bag, and store or carry away from metallic objects (clips, etc.).

**If you drop the battery accidentally, check to see if the body of the battery and the terminals are damaged.**

- Inserting a damaged battery in the camera will damage the camera.

**Bring charged spare batteries when going out.**

- Be aware that recordable time will become shorter in cold places such as ski resorts or places at high altitude.
- When you travel, do not forget to bring the battery charger (supplied) so that you can charge the battery in the country that you are travelling in.

**Dispose of unusable battery.**

- The battery has a limited life.
- Do not throw the battery into fire because it may cause an explosion.

**Do not allow battery terminals to come into contact with metal objects (such as necklaces, hairpins etc.).**

- This can cause short circuiting or heat generation and you may be badly burned if you touch a battery.

## Charger

- If you use the battery charger near a radio, the radio reception may be disturbed.
- Keep the charger 1 m (3.3 feet) or more away from radios.
- The charger may generate whirring sounds when it is being used. This is not a malfunction.
- After use, be sure to disconnect the power supply device from the electrical outlet. (A very small amount of current is consumed if it is left connected.)
- Keep the terminals of the charger and battery clean.

## About 3D

### ■ About 3D viewing

**Anyone who is hypersensitive to light, suffers from heart disease or is otherwise unwell should avoid viewing 3D pictures.**

- Doing so may have an adverse affect on such medical conditions.

**If you feel tired, uncomfortable or otherwise strange when viewing 3D pictures, stop viewing at once.**

- Continuing to view may cause illness.
- Please rest appropriately after stopping the viewing.

**When viewing 3D pictures, we recommend taking a break every 30 to 60 minutes.**

- Viewing for extended periods may cause eye-fatigue.

**Short-sighted or long-sighted persons, those with differences in the sight of their right and left eyes, and those with astigmatism are advised to correct their vision by wearing glasses etc.**

**Stop viewing if you can clearly see a double image while viewing 3D pictures.**

- There are differences in the way that different people experience 3D pictures. Please correct your sight appropriately before viewing 3D pictures.
- You can change the 3D setting of your television or 3D output setting of the unit to 2D.

**When viewing 3D pictures on a 3D compatible television, position yourself a distance away that is least 3 times the effective height of the television.**

- Viewing from a distance closer than the recommended distance may lead to eye-fatigue.

## Card

**Do not leave the card where the temperature is high, where electromagnetic waves or static electricity are easily generated or exposed to direct sunlight.**

**Do not bend or drop the card.**

- The card may be damaged or the recorded content may be damaged or deleted.
- Put the card in the card case or the storage bag after use and when storing or carrying the card.
- Do not allow dirt, dust or water to get into the terminals on the back of the card and do not touch the terminals with your fingers.

**Notice for when transferring to another party, or disposing of the memory card**

- “Format” or “delete” using the camera or a PC will only modify the file management information, and it will not erase the data in the memory card completely.

It is recommended to physically destroy the memory card or use the commercially available computer data deletion software to completely erase the data in the memory card before transferring to another party or disposing.

Management of data in the memory card is the responsibility of the user.

## About the personal information

If a name or birthday is set for [Baby1]/[Baby2]/Face Recognition function, this personal information is kept in the camera and recorded in the image.

### Disclaimer

- Information including personal information may be altered or vanish due to erroneous operation, effect of static electricity, accident, malfunction, repair, or other handlings. Please note in advance that Panasonic is not liable in any way for any direct or indirect damage from the alteration or vanishing of information or personal information.

**When requesting a repair, transferring to another party or disposing**

- Reset the settings to protect the personal information. (P57)
- If there are pictures stored in the built-in memory, copy them into the memory card (P154) before formatting the built-in memory (P60) as needed.
- Remove the memory card from the camera when requesting a repair.
- Built-in memory and settings may return to factory default when camera is repaired.
- Please contact the dealer where you purchased the camera or your nearest Service Centre if above operations are not possible due to malfunction.

**When transferring to another party, or disposing of the memory card, please refer to “Notice for when transferring to another party, or disposing of the memory card” above.**

### When not using the camera for a long period of time

- Store the battery in a cool and dry place with a relatively stable temperature: [Recommended temperature: 15 °C to 25 °C (59 °F to 77 °F), Recommended humidity: 40%RH to 60%RH]
- Always remove the battery and the card from the camera.
- If the battery is left inserted in the camera, it will discharge even if the camera is turned off. If the battery continues to be left in the camera, it will discharge excessively and may become unusable even if charged.
- When storing the battery for a long period of time, we recommend charging it once a year. Remove the battery from the camera and store it again after it has completely discharged.
- We recommend storing the camera with a desiccant (silica gel) when you keep it in a closet or a cabinet.

### About the picture data

Recorded data may be damaged or lost if the camera breaks down due to inappropriate handling. Panasonic will not be liable for any damage suffered due to loss of recorded data.

### About tripods or unipods

- When you use a tripod, make sure the tripod is stable when this unit is attached to it.
- You may not be able to remove the card or the battery when using a tripod or unipod.
- Make sure that the screw on the tripod or unipod is not at an angle when attaching or detaching the camera. You may damage the screw on the camera if you use excessive force when turning it. Also, the camera body and the rating label may be damaged or scratched if the camera is attached too tightly to the tripod or unipod.
- Read the operating instructions for the tripod or unipod carefully.
- Some tripods or unipods cannot be attached when the AC adaptor (optional) are connected.

**Important!**

**Be sure to read the following before using the location names that are stored in this product.**

**User License Agreement for Location Name data****Personal Use Only.**

You agree to use this Data together with this digital camera for the solely personal, non-commercial purposes for which you were licensed, and not for service bureau, time-sharing or other similar purposes. Accordingly, but subject to the restrictions set forth in the following paragraphs, you agree not to otherwise reproduce, copy, modify, decompile, disassemble or reverse engineer any portion of this Data, and may not transfer or distribute it in any form, for any purpose, except to the extent permitted by mandatory laws. Multi-disc sets may only be transferred or sold as a complete set as provided by Panasonic Corporation and not as a subset thereof.

**Restrictions.**

Except where you have been specifically licensed to do so by Panasonic Corporation, and without limiting the preceding paragraph, you may not (a) use this Data with any products, systems, or applications installed or otherwise connected to or in communication with vehicles, capable of vehicle navigation, positioning, dispatch, real time route guidance, fleet management or similar applications; or (b) with or in communication with any positioning devices or any mobile or wireless-connected electronic or computer devices, including without limitation cellular phones, palmtop and handheld computers, pagers, and personal digital assistants or PDAs.

**Warning.**

The Data may contain inaccurate or incomplete information due to the passage of time, changing circumstances, sources used and the nature of collecting comprehensive geographic data, any of which may lead to incorrect results.

**No Warranty.**

This Data is provided to you "as is," and you agree to use it at your own risk. Panasonic Corporation and its licensors (and their licensors and suppliers) make no guarantees, representations or warranties of any kind, express or implied, arising by law or otherwise, including but not limited to, content, quality, accuracy, completeness, effectiveness, reliability, fitness for a particular purpose, usefulness, use or results to be obtained from this Data, or that the Data or server will be uninterrupted or error-free.

**Disclaimer of Warranty:**

PANASONIC CORPORATION AND ITS LICENSORS (INCLUDING THEIR LICENSORS AND SUPPLIERS) DISCLAIM ANY WARRANTIES, EXPRESS OR IMPLIED, OF QUALITY, PERFORMANCE, MERCHANTABILITY, FITNESS FOR A PARTICULAR PURPOSE OR NON-INFRINGEMENT. Some States, Territories and Countries do not allow certain warranty exclusions, so to that extent the above exclusion may not apply to you.

**Disclaimer of Liability:**

PANASONIC CORPORATION AND ITS LICENSORS (INCLUDING THEIR LICENSORS AND SUPPLIERS) SHALL NOT BE LIABLE TO YOU: IN RESPECT OF ANY CLAIM, DEMAND OR ACTION, IRRESPECTIVE OF THE NATURE OF THE CAUSE OF THE CLAIM, DEMAND OR ACTION ALLEGING ANY LOSS, INJURY OR DAMAGES, DIRECT OR INDIRECT, WHICH MAY RESULT FROM THE USE OR POSSESSION OF THE INFORMATION; OR FOR ANY LOSS OF PROFIT, REVENUE, CONTRACTS OR SAVINGS, OR ANY OTHER DIRECT, INDIRECT, INCIDENTAL, SPECIAL OR CONSEQUENTIAL DAMAGES ARISING OUT OF YOUR USE OF OR INABILITY TO USE THIS INFORMATION, ANY DEFECT IN THE INFORMATION, OR THE BREACH OF THESE TERMS OR CONDITIONS, WHETHER IN AN ACTION IN CONTRACT OR TORT OR BASED ON A WARRANTY, EVEN IF PANASONIC CORPORATION OR ITS LICENSORS HAVE BEEN ADVISED OF THE POSSIBILITY OF SUCH DAMAGES. Some States, Territories and Countries do not allow certain liability exclusions or damages limitations, so to that extent the above may not apply to you.

**Export Control.**

Panasonic Corporation shall not export from anywhere any part of the Data or any direct product thereof except in compliance with, and with all licenses and approvals required under, applicable export laws, rules and regulations, including but not limited to the laws, rules and regulations administered by the Office of Foreign Assets Control of the U.S. Department of Commerce and the Bureau of Industry and Security of the U.S. Department of Commerce. To the extent that any such export laws, rules or regulations prohibit NT from complying with any of its obligations hereunder to deliver or distribute Data, such failure shall be excused and shall not constitute a breach of this Agreement.

**Entire Agreement.**

These terms and conditions constitute the entire agreement between Panasonic Corporation (and its licensors, including their licensors and suppliers) and you pertaining to the subject matter hereof, and supersedes in their entirety any and all written or oral agreements previously existing between us with respect to such subject matter.

## About location information/place name information

### About the geographical coordinate system

The latitude and longitude standard (geographical coordinate system) recorded with this camera is WGS84.

### About copyright

According to copyright law, the map data stored in this camera may not be used for purposes other than personal use without the permission of the copyright holder.

### About navigation functions

This camera is not equipped with a navigation function.

## Notices related to licensed software copyright holders



© 2011 NAVTEQ. All rights reserved.



"MAPPLE" is a trademark of Shobunsha Publications, Inc.

## MAPPLE

This data includes information taken with permission from Canadian authorities, including © Her Majesty the Queen in Right of Canada,

© Queen's Printer for Ontario, © Canada Post Corporation, GeoBase®,

© Department of Natural Resources Canada. All rights reserved.

© United States Postal Service® 2011, USPS®, ZIP+4®

Fuente: INEGI (Instituto Nacional de Estadística y Geografía)

Traffic Codes for Belgium are provided by the Ministerie van de Vlaamse Gemeenschap and the Ministerie de l'Equipement et des Transports.

Territory	Notice
Australia	© Hema Maps Pty. Ltd, 2011. Copyright. Based on data provided under license from PSMA Australia Limited (www.pasma.com.au). Product incorporates data which is © 2011 Telstra Corporation Limited, GM Holden Limited, Intelematics Australia Pty Ltd, NAVTEQ International LLC, Sentinel Content Pty Limited and Continental Pty Ltd.
Austria	"© Bundesamt für Eich- und Vermessungswesen"
Croatia, Cyprus, Estonia, Latvia, Lithuania, Moldova, Poland, Slovenia and/or Ukraine	"© EuroGeographics"
Ecuador	INSTITUTO GEOGRAFICO MILITAR DEL ECUADOR AUTORIZACION N° IGM-2011-01- PCO-01 DEL 25 DE ENERO DE 2011
France	The following notice must appear on all copies of the Data, and may also appear on packaging: "source: © IGN France – BD TOPO ®"
Germany	"Die Grundlagendaten wurden mit Genehmigung der zuständigen Behörden entnommen" or "Die Grundlagendaten wurden mit Genehmigung der zustaendigen Behoerden entnommen."
Great Britain	"Contains Ordnance Survey data © Crown copyright and database right 2010 Contains Royal Mail data © Royal Mail copyright and database right 2010"
Greece	"Copyright Geomatics Ltd."

<b>Territory</b>	<b>Notice</b>
Guadeloupe, French Guiana Martinique	"source: © IGN 2009 - BD TOPO ®"
Guatemala	"Aprobado por el INSTITUTO GEOGRAFICO NACIONAL – Resolución del IGN N° 186-2011"
Hungary	"Copyright © 2003; Top-Map Ltd."
Israel	"© Survey of Israel data source"
Italy	"La Banca Dati Italiana è stata prodotta usando quale riferimento anche cartografia numerica ed al tratto prodotta e fornita dalla Regione Toscana."
Jordan	"© Royal Jordanian Geographic Centre". The foregoing notice requirement for Jordan Data is a material term of the Agreement. If Client or any of its permitted sublicensees (if any) fail to meet such requirement, NT shall have the right to terminate Client's license with respect to the Jordan Data.
Mozambique	"Certain Data for Mozambique provided by Cenacarta © 2011 by Cenacarta"
Norway	"Copyright © 2000; Norwegian Mapping Authority"
Portugal	"Source: IgeoE – Portugal"
Réunion	"source: © IGN 2009 - BD TOPO ®"
Spain	"Información geográfica propiedad del CNIG"
Nepal	Copyright © Survey Department, Government of Nepal.
Sri Lanka	This product incorporates original source digital data obtained from the Survey Department of Sri Lanka © 2009 Survey Department of Sri Lanka The data has been used with the permission of the Survey Department of Sri Lanka
Sweden	"Based upon electronic data © National Land Survey Sweden."
Switzerland	"Topografische Grundlage: © Bundesamt für Landestopographie."

### ■ Landmark types

The following points of interest, such as tourist spots and public facilities, are displayed as landmarks.

- Although approx. 1,000,000 landmarks, are registered in the built-in memory, there are some unregistered landmarks. (The registered information is current as of December 2011 and will not be updated.)

Zoo	Botanical garden	Aquarium
Amusement park	Golf course	Camp sites
Ski resorts	Skating rinks	Outdoor activity sites
Famous site, tourist attraction, beauty spot	Castle, ruins	Shrine
Temple	Church	Tomb, monument, mound, historic site
Airport	Port	Ferry terminal
Baseball park	Athletics ground	Gymnasium
Park	Station	Prefectural or state office
Lifts, cable cars	Art museum	History museum
Theater	Cinemas, performing theatres	Wineries, sake makers
Mountains, meadows, passes	Canyons, mountain streams, waterfalls, valleys, seashores	Tower, high buildings

## Message Display

Confirmation messages or error messages will be displayed on the screen in some cases. The major messages are described below as examples.

### **[GPS feature is not available in this region.]**

- The GPS may not operate in China or close to the Chinese border in neighbouring countries. (As of December 2011)

### **[This picture is protected]**

→ Delete the picture after cancelling the protect setting. (P152)

### **[Some pictures cannot be deleted]/[This picture cannot be deleted]**

- Pictures not based on the DCF standard cannot be deleted.  
→ Format the card after saving necessary data on a PC etc. (P60)

### **[Cannot be set on this picture]**

- [Title Edit], [Text Stamp] or [Print Set] cannot be set for pictures not based on the DCF standard.

### **[Built-in memory full]/[Memory card full]/[Not enough space on built-in memory]/[Not enough memory on the card]**

- There is no space left on the built-in memory or the card.
- When you copy pictures from the built-in memory to the card (batch copy), the pictures are copied until the capacity of the card becomes full.

### **[Some pictures cannot be copied]/[Copy could not be completed]**

- The following pictures cannot be copied.
  - When a picture with the same name as the picture to be copied exists in the copy destination. (Only when copying from a card to the built-in memory.)
  - Files not based on the DCF standard.
- Moreover, pictures recorded or edited by other equipment may not be copied.

### **[Built-In Memory Error]/[Format built-in memory?]**

- This message will be displayed when you formatted the built-in memory on a PC.  
→ Format the built-in memory on the camera again. (P60) The data on the built-in memory will be deleted.

**[Memory card error.  
This card cannot be used in this camera.  
Format this card?]**

- It is a format that cannot be used with this unit.
  - Insert a different card.
  - Format the card again with the camera after saving necessary data on a PC etc. (P60)  
Data will be deleted.

**[Please turn camera off and then on again]/[System Error]**

- This message will be displayed when the lens did not operate properly.
  - Turn the camera off and on. If the message persists, contact the dealer or your nearest Service Centre.

**[Memory Card Error]/[Memory card parameter error]/[This memory card cannot be used]**

- Use a card compatible with this unit. (P24)
- SD Memory Card (8 MB to 2 GB)
- SDHC Memory Card (4 GB to 32 GB)
- SDXC Memory Card (48 GB, 64 GB)

**[Insert SD card again]/[Try another card]**

- An error has occurred accessing the card.
  - Insert the card again.
  - Insert a different card.

**[Read Error/Write Error  
Please check the card]**

- It has failed to read or write data.
  - Remove the card after turning the power off. Insert the card again, turn the power on, and try to read or write the data again.
- The card may be broken.
  - Insert a different card.

**[Motion recording was cancelled due to the limitation of the writing speed of the card]**

- Use a card with SD Speed Class with “Class 4” or higher when recording motion pictures.
- In the event that it stops even after using a “Class 4” card or higher, the data writing speed has deteriorated so it is recommended to make a backup and then format (P60).
- Depending on the type of the card, Motion Picture Recording may stop in the middle.

**[Cannot record due to incompatible format(NTSC/PAL) data on this card.]**

- Format the card after saving necessary data on a PC etc. (P60)
- Insert a different card.

**[A folder cannot be created]**

- A folder cannot be created because there are no remaining folder numbers that can be used.
  - Format the card after saving necessary data on a PC etc. (P60) If you execute [No.Reset] in the [Setup] menu after formatting, the folder number is reset to 100. (P57)

**[Picture is displayed for 16:9 TV]/[Picture is displayed for 4:3 TV]**

- Select [TV Aspect] in the [Setup] menu if you want to change the TV aspect. (P58)
- This message also appears when the USB connection cable is connected to the camera only. In this case, connect the other end of the USB connection cable to a PC or a printer. (P165, 169)

**[Editing operation cannot proceed as information processing is ongoing.]**

- If a card inserted into the unit contains a group of pictures taken in [Time Lapse Shot] and one or more pictures from the group have been deleted or have had their file names changed in a PC or other device, the unit automatically retrieves new information and reconstitutes the group. When there are many image files, the currently retrieving information icon [, ] may be displayed for a significant period on the playback screen. During this period, it will not be possible to use delete or the playback menu.  
If you turn off this unit while information is being retrieved, only the still pictures for which data has been retrieved will be saved as the group. When you switch on again, the information retrieval will restart from the same point.

**[Recording failed.]**

- You may not record when the recording location is too dark/too bright, or if the subject does not have enough contrast when recording in 3D.

**[This battery cannot be used]**

- Use a genuine Panasonic battery. If this message is displayed even when a genuine Panasonic battery is used, contact the dealer or your nearest Service Centre.
- If the battery terminal is dirty, clean it and remove any objects.

**[To prevent water leakage, ensure that the door is locked properly.]**

- Refer to P22 for details.

## Troubleshooting

First, try out the following procedures (P193–204).

If the problem is not resolved, it may be improved by selecting **[Reset] (P57)** on the **[Setup]** menu.

### Battery and power source

**The camera cannot be operated even when it is turned on.  
The camera turns off immediately after it is turned on.**

- The battery is exhausted. Charge the battery.
- If you leave the camera on, the battery will be exhausted.  
→ Turn the camera off frequently by using the **[Economy]** etc. (P56)

**This unit is turned off automatically.**

- If you connect to a TV compatible with VIERA Link with an HDMI micro cable (optional) and turn off the power on the TV with the remote control for the TV, the power on this unit also turns off.  
→ If you are not using VIERA Link, set **[VIERA Link]** to **[OFF]**. (P59)

**Side door does not close.**

- Insert all the way until you hear a locking sound and it is locked by the lever while being careful about the direction the battery is inserted. (P21)

## About the GPS

### Positioning is not possible.

- [GPS Setting] is set to [OFF]. (P115)
- Radio waves from GPS satellites may not be received depending on the recording environment, such as indoors or close to a building. (P114)
  - It is recommended to use by holding the camera still for a while at an outdoor location clear to the sky, with the antenna pointed upward.



### GPS status indicator is lit while the power is turned off.

- [GPS Setting] is set to [ON].
  - Set [GPS Setting] to [OFF] or [Airplane Mode] to [ON] when you turn the unit off onboard an airplane or inside a hospital etc. (P131)

### Positioning takes time.

- It may take a few minutes the first time you use it or when it has not been used for a while.
- Positioning is performed within 2 minutes normally, but since the position of the GPS satellites change, it may take longer depending on the location or environment of the recording.
- It will take longer for positioning in an environment where it is harder to receive the radio waves from the GPS satellites. (P114)

### Location name information is different from the place the picture was recorded in.

- Straight after the power is turned on, or when the GPS icon is not set to [, current location and location name information stored in the unit may differ significantly.
- It can be changed to a different candidate before recording a picture when [] is displayed. (P119)

### Location name information is not displayed.

- When a landmark etc. does not exist nearby or no information is registered in the database of the unit, [---] is displayed. (P117)
  - You can enter location names etc. with [Place-Name Edit] during the playback. (P142)

## Recording

### The picture cannot be recorded.

- Is there any memory remaining on the built-in memory or the card?  
→ Delete the pictures which are not necessary to increase the available memory. (P44)
- You may not be able to record for a short while after turning the power on when using a large capacity card.

### The recorded picture is whitish.

- The picture can become whitish if there is dirt e.g. fingerprints on the lens.  
→ When it is dirty, lightly wipe the surface of the lens with soft and dry cloth.
- Is the inside of the lens fogged?  
→ There is condensation. Refer to "When inner side of the lens is fogged (condensation)" on P6 for what to do.

### The recorded picture is too bright or dark.

- Check that the exposure is correctly compensated. (P70)
- Setting the [Min. Shtr Speed] to faster speed might make the picture darker.  
→ Set the [Min. Shtr Speed] (P101) to slower speed.

### Multiple pictures are taken at one time.

→ Set Auto Bracket (P71) or [Burst] (P103) of the [Rec] menu to [OFF].

### The subject is not focused properly.

- The focus range varies depending on the Recording Mode.  
→ Set to the proper mode for the distance to the subject.
- The subject is beyond the focus range of the camera. (P33)
- There is camera shake (jitter) or the subject is moving slightly. (P29)

### The auto-focus and other operations are not working normally.

- Turn the power on again. If the operations are still not working normally, remove the power and consult the dealer or your nearest Service Centre.

**The recorded picture is blurred.  
The Optical Image Stabiliser is not effective.**

- The shutter speed becomes slower when pictures are taken in dark places so hold the camera firmly with both hands to take the pictures. (P29)
- When taking pictures at a slow shutter speed, use the Self-timer. (P69)

**Taking pictures using Auto Bracket is not possible.**

- Is there any memory remaining on the built-in memory or the card?

**The recorded picture looks rough.  
Noise appears on the picture.**

- Is the ISO sensitivity high or the shutter speed slow? (ISO sensitivity is set to [AUTO] when the camera is shipped. Therefore, when taking pictures indoors etc. noise will appear.)
  - Decrease the ISO sensitivity. (P94)
  - Take pictures in bright places.
- Have you set [High Sens.] in Scene Mode, or [Burst] in [Rec] menu to [ ] or [ ]? If so, the resolution of the recorded picture decreases slightly because of high sensitivity processing, but this is not a malfunction.

**The brightness or the hue of the recorded picture is different from the actual scene.**

- When recording under fluorescent or LED lighting fixture etc., increasing the shutter speed may introduce slight changes to brightness and colour. These are a result of the characteristics of the light source and do not indicate a malfunction.

**When recording pictures or half-pressing the shutter button, reddish stripes may appear on the LCD monitor. Alternatively, part or all of the LCD monitor may turn a reddish colour.**

- This is a characteristic of CCDs, and it appears when the subject has a bright part. Some unevenness may occur in the surrounding areas, but this is not a malfunction.  
It is recorded in motion pictures but is not recorded on still pictures.
- It is recommended that when you take pictures you take care not to expose the screen to sunlight or any other source of strong light.

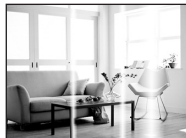

**Motion Picture Recording stops in the middle.**

- Use a card with SD Speed Class with “Class 4” or higher when recording motion pictures.
- Depending on the type of the card, recording may stop in the middle.
  - If Motion Picture Recording stops during use of a card of at least “Class 4” or if you use a card that has been formatted on a PC or other equipment, the data-writing speed is lower. In such cases, we recommend that you make a backup of the data and then format (P60) the card in this unit.

**Subject cannot be locked.  
(AF tracking not possible)**

- Set the AF area to the distinctive colour of the subject if there is a part that is different from the surrounding colour. (P99)

**Recording by [Panorama Shot] is ended before finishing.**

- If the camera is moved too slowly, the camera has assumed that camera motion was stopped and will end the still picture recording.
- If there is a great deal of shaking towards the recording direction while moving the camera, recording will end.
  - When recording with [Panorama Shot], move the camera by trying to trace a small circle parallel to the recording direction at a speed of about 8 seconds per revolution (estimated).

**Lens****Recorded image may be warped, or nonexistent colour is surrounding the subject.**

- It is possible that the subject may be warped slightly, or the borders get coloured, depending on the zoom magnification, due to the characteristics of the lens. Also, the peripherals of the image might look warped because the perspective is enhanced when the wide angle is used. This is not a malfunction.

**The inner side of the lens is fogged.**

- The inside of the lens may fog due to condensation depending on the environment this unit is used in, areas that undergo a significant change in temperature or in high humidity, etc. Refer to “When inner side of the lens is fogged (condensation)” on P6 for what to do.

## LCD monitor

### The LCD monitor becomes darker or brighter for a moment.

- This phenomenon appears when you press the shutter button halfway to set the aperture value and does not affect the recorded pictures.
- This phenomenon also appears when the brightness changes when the camera is zoomed or when the camera is moved. This is because of operation of the automatic aperture of the camera, and it is not a malfunction.

### The LCD monitor flickers indoors.

- The LCD monitor may flicker for a few seconds after the power is turned on. This is an operation to correct flicker caused by lighting such as fluorescent lights, LED lights, etc. and is not a malfunction.

### The LCD monitor is too bright or dark.

- Is [LCD Mode] active? (P53)
- Perform [LCD Display]. (P52)

### Black, red, blue and green dots appear on the LCD monitor.

- This is not a malfunction.  
These pixels do not affect the recorded pictures.

### Noise appears on the LCD monitor.

- In dark places, noise may appear to maintain the brightness of the LCD monitor. This does not affect the pictures you are recording.

## Flash

### The flash is not activated.



- Is the flash setting set to [☺]?  
→ Change the flash setting. (P65)
- The flash cannot be used in the following cases:
  - When using Auto Bracket (P71)
  - In Miniature Effect Mode (P77)
  - [Scenery]/[Panorama Shot]/[Night Scenery]/[Handheld Night Shot]/[Sunset]/[Glass Through] in Scene Mode (P78)
  - In 3D Photo Mode (P85)
  - When recording in [Burst] (except for [☺]) (P103)

### Flash is activated several times.

- The flash is activated twice when Red-Eye Reduction (P65) has been set.
- Has [Burst] (P103) in the [Rec] menu been set to [☺]?

## Playback

**The picture being played back is rotated and displayed in an unexpected direction.**

- [Rotate Disp.] (P59) is set to [] or [].

**The picture is not played back.  
The recorded pictures are not displayed.**

- Is there a picture on the built-in memory or the card?  
→ The pictures on the built-in memory appear when a card is not inserted. The picture data on the card appears when a card is inserted.
- Is this a folder or picture which was processed in the PC? If it is, it cannot be played back by this unit.  
→ It is recommended to use the "PHOTOfunSTUDIO" software in the CD-ROM (supplied) to write pictures from PC to card.
- Has [Filtering Play] been set for playback?  
→ Change to [Normal Play]. (P132)

**The folder number and the file number are displayed as [—] and the screen turns black.**

- Is this a non-standard picture, a picture which has been edited using a PC or a picture which was taken by another make of digital camera?
- Did you remove the battery immediately after picture-taking or did you take the picture using a battery with a low remaining charge?  
→ Format the data to delete the pictures mentioned above. (P60)  
(Other pictures will be deleted as well and it will not be possible to restore them. Therefore, check well before formatting.)





**With a Calendar Search, pictures are displayed on dates differing from the actual dates on which the pictures were taken.**

- Is the clock in the camera set properly? (P27)
- When pictures edited using a PC or pictures taken by other equipment are searched, they may be displayed on dates differing from the actual dates on which the pictures were taken.

**White round spots like soap bubbles appear on the recorded picture.**

- If you take a picture with the flash in a dark place or indoors, white round spots may appear on the picture caused by the flash reflecting of particles of dust in the air. This is not a malfunction. A characteristic of this is that the number of round spots and their position differ in every picture.

**Red part of the recorded image has changed colour to black.**

- When Digital Red-Eye Correction ([, [) is in operation, if you take a picture of subject with red colour surrounded by a skin tone colour, that red part may be corrected to black by the Digital Red-Eye Correction function.  
→ It is recommend to take picture with Flash Mode set to [, [) or [) or [Red-Eye Removal] on the [Rec] menu set to [OFF]. (P109)

**[Thumbnail is displayed] appears on the screen.**

- Is it a picture that has been recorded with other equipment? In such cases, these pictures may be displayed with a deteriorated picture quality.

**The sound of the recorded motion pictures sometimes breaks up.**

- This unit automatically adjusts the aperture during Motion Picture Recording. At such times, the sound may break up. This is not a malfunction.

**Motion pictures recorded with this model can not be played back on other equipment.**

- Motion pictures recorded in [AVCHD] or [MP4] may be played back with poor picture or sound quality or playback may not be possible even when played back with equipment compatible with these formats. Also, the recording information may not be displayed properly.

## TV, PC and printer

### The picture does not appear on the television.

- Is the camera connected to the TV correctly?  
→ Set the TV input to External Input Mode.

### The display areas on the TV screen and the camera's LCD monitor are different.

- Depending on the TV model, the pictures may be extended horizontally or vertically or they may be displayed with their edges cut off.

### The motion pictures cannot be played back on a TV.

- Are you trying to play back the motion pictures by directly inserting the card in the card slot of the TV?  
→ Connect the camera to the TV with the AV cable (supplied), or with the HDMI micro cable (optional), and then play back the motion pictures on the camera. (P155)

### The picture is not displayed fully on the TV.

- Check [TV Aspect] setting. (P58)

### VIERA Link does not work.

- Is it connected properly with the HDMI micro cable (optional)? (P155)  
→ Confirm that the HDMI micro cable (optional) is firmly fitted.  
→ Press [ ] on this unit.
- Is the [VIERA Link] on this unit set to [ON]? (P59)  
→ Depending on HDMI terminal of the TV, the input channel may not switch automatically. In this case, use the remote control for the TV to switch input. (For details on how to switch input, please read the operating instructions for the TV.)  
→ Check the VIERA Link setting on the connected device.  
→ Turn the power to the unit off and then back on again.  
→ Set [HDAVI Control] to [Off] on the TV and then turn it back to [On]. (Refer to the operating instructions of the TV for details.)  
→ Check [Video Out] setting. (P58)

### The picture cannot be transferred when the camera is connected to a PC.

- Is the camera connected to the PC correctly?
- Is the camera recognised by the PC correctly?  
→ Set to [PC] in [USB Mode]. (P58, 165)

**The card is not recognised by the PC. (The built-in memory is recognised.)**

- Disconnect the USB connection cable. Connect it again while the card is inserted in the camera.
- If there are two or more USB terminal on a single PC, try connecting the card to another USB terminal.

**The card is not recognised by the PC. (SDXC memory card is used.)**

- Check if your PC is compatible with SDXC memory cards.  
<http://panasonic.net/avc/sdcard/information/SDXC.html>
- A message prompting to format the card may be displayed when connecting, but do not format.
- If the [Access] displayed on the LCD monitor does not disappear, disconnect the USB connection cable after turning off the power.

**There is a problem trying to upload to YouTube or Facebook.**

- Confirm that the login information (login ID/user name/mail address/password) is correct.
- Confirm that the PC is connected to the Internet.
- Confirm that resident software such as virus protection software or firewall is not blocking access to YouTube or Facebook.
- Confirm with YouTube or Facebook as well.

**The picture cannot be printed when the camera is connected to a printer.**

- Pictures cannot be printed using a printer which does not support PictBridge.
  - Set to [PictBridge(PTP)] in [USB Mode]. (P58, 169)

**The ends of the pictures are cut at printing.**

- When using a printer with a Cropping or Borderless Printing function, cancel this function before printing. (For details, refer to the operating instructions for the printer.)
- When you order photo studios to print pictures, ask the photo studio if the pictures can be printed with both ends.

**The panorama picture is not printing correctly.**



- Since aspect ratio of a panorama picture differs from normal pictures, it may not always be possible to print it correctly.
  - Please use a printer that supports panorama pictures. (For details, please see the operating instructions of your printer)
  - We recommend using the "PHOTOfunSTUDIO" software on the CD-ROM (supplied) to adjust the size of the still picture to the print paper size.

## Others

**[Requirements for Underwater use] is displayed repeatedly whenever the power is turned on.**

- Press [MENU/SET] after viewing the last screen (12/12). For details, refer to P9.

**An unreadable language was selected by mistake.**

→ Press [MENU/SET], select the [Setup] menu icon [  ]. Then press [MENU/SET], and then select the [  ] icon to set the desired language. (P60)

**A white lamp sometimes turns on when the shutter button is pressed halfway.**

- AF Assist Lamp will turn on white in the dark place to assist the focusing.

**The AF Assist Lamp does not turn on.**

- Is [AF Assist Lamp] on the [Rec] menu set to [ON]? (P108)
- The AF Assist Lamp does not turn on in bright places.

**The camera becomes warm.**

- The surface of the camera may become warm during use. This does not affect the performance or quality of the camera.

**The side door will not close.**

- Have foreign objects become trapped?  
→ Remove the foreign objects. (P10)
- When closing, do not set the [LOCK] switch to the locked side. Doing so may cause damage or leaks.  
→ Release the lock. (P21)

**A part of the camera such as the zoom button and side door does not move.**

- If the camera is used in cold places such as ski resorts or places at high altitude with the snow or water droplets adhered to the camera, some parts of the camera may become hard to move with snow or water droplets freezing in the gap of the zoom button or the camera [ON/OFF] button. This is not a malfunction. When the camera returns to normal temperature it will function as normal.
- When using the camera in a place with sand or dust, some parts of the camera may become hard to move with foreign objects getting in the gap of the zoom button, or the camera [ON/OFF] button. Either clean with the supplied brush or wash off with fresh water.

**The camera makes a rattling sound or you can feel some vibration.**

- Below cases are not malfunctions, so you can use the camera as normal.  
→ You hear a "rattling" sound when the camera is shaken while the power is off or during Playback Mode (this is the sound of the lens moving).  
→ When power is turned on or off, or when switching from recording to Playback Mode, there is a rattling noise (this is the sound of the lens moving).  
→ When zooming, you can feel some vibration (this is caused by the lens moving).

**The lens clicks.**

- When the brightness changes due to zoom or camera movement etc., the lens may click and the picture on the screen may drastically change. However, the picture is not affected. The sound is caused by the automatic adjustment of the aperture. This is not a malfunction.

**The clock is reset.**

- If you do not use the camera for a long time, the clock may be reset.  
→ [Please set the clock] message will be displayed; please reset the clock. (P27)

**Zooming stops instantaneously.**

- When using the Extra Optical Zoom, the zooming action will stop temporarily. This is not a malfunction.

**Zoom does not go up to maximum magnification.**

- Is the camera set to Macro Zoom Mode? (P68)  
Maximum zoom during Macro Zoom Mode is 3× digital zoom.

**The file numbers are not recorded consecutively.**

- When you perform an operation after taking a certain action, the pictures may be recorded in folders with different numbers from the ones used prior to the operation.

**The file numbers are recorded in ascending order.**

- If the battery was inserted or removed without first turning the camera's power off, the folder and file numbers for the pictures taken will not be stored in the memory. When the power is then turned back on and pictures are taken, they may be stored under file numbers which should have been assigned to previous pictures.

**When the camera is left alone, the slide show is suddenly displayed.**

- This is the [Auto Demo] to introduce the features of the camera. Press a button to return the camera to the original screen.

**Bearing information measured with this unit is different from the public bearing indications.**

- When [GPS Setting] is set to [OFF], magnetic declination is not corrected.  
→ Perform [Repositioning] of [GPS/Sensor] menu (P118), and acquire correct latitude/longitude of the current location.

- SDXC Logo is a trademark of SD-3C, LLC.
- “AVCHD” and the “AVCHD” logo are trademarks of Panasonic Corporation and Sony Corporation.
- Manufactured under license from Dolby Laboratories.  
Dolby and the double-D symbol are trademarks of Dolby Laboratories.
- HDMI, the HDMI Logo, and High-Definition Multimedia Interface are trademarks or registered trademarks of HDMI Licensing LLC in the United States and other countries.
- HDAVI Control™ is a trademark of Panasonic Corporation.
- QuickTime and the QuickTime logo are trademarks or registered trademarks of Apple Inc., used under license therefrom.
- iMovie, Mac and Mac OS are trademarks of Apple Inc., registered in the U.S. and other countries.
- Windows and Windows Vista are either registered trademarks or trademarks of Microsoft Corporation in the United States and/or other countries.
- YouTube is a trademark of Google Inc.
- This product uses “DynaFont” from DynaComware Corporation. DynaFont is a registered trademark of DynaComware Taiwan Inc.
- Other names of systems and products mentioned in these instructions are usually the registered trademarks or trademarks of the manufacturers who developed the system or product concerned.

**AVCHD**™

**DOLBY**  
DIGITAL  
CREATOR

**HDMI**



This product is licensed under the AVC patent portfolio license for the personal and non-commercial use of a consumer to (i) encode video in compliance with the AVC Standard (“AVC Video”) and/or (ii) decode AVC Video that was encoded by a consumer engaged in a personal and non-commercial activity and/or was obtained from a video provider licensed to provide AVC Video. No license is granted or shall be implied for any other use. Additional information may be obtained from MPEG LA, LLC. See <http://www.mpegla.com> .