

Panasonic®

English

Model No.

TH-60A430G
TH-60A430K
TH-60A430M

Operating Instructions LED TV



VIERA

Contents

Be Sure to Read

Important Notice	2
Safety Precautions	3

Quick Start Guide

Accessories	4
Connections	5
Identifying Controls	7
First time Auto Tuning	9

Using your VIERA

Watching External Inputs	9
--------------------------	---

Child Lock	10
Using Menu Functions	10
Tuning and Editing Channels	13
Using Media Player	14
VIERA Link	16
Technical Information	18

Others

FAQs	20
Maintenance	21
Specifications	21

Thank you for purchasing this Panasonic product.

Please read these instructions carefully before operating this product and retain them for future reference.

The images shown in this manual are for illustrative purposes only.



TQB4GC1219



(TH-60A430K)

(TH-60A430M)



Even if no special notation has been made of company or product trademarks, these trademarks have been fully respected.

- HDMI, the HDMI Logo, and High-Definition Multimedia Interface are trademarks or registered trademarks of HDMI Licensing LLC in the United States and other countries.
- Manufactured under license from Dolby Laboratories. Dolby and the double-D symbol are trademarks of Dolby Laboratories.
- For DTS patents, see <http://patents.dts.com>. Manufactured under license from DTS Licensing Limited. DTS, the Symbol, & DTS and the Symbol together are registered trademarks and DTS 2.0+Digital Out is a trademark of DTS, Inc. © DTS, Inc. All Rights Reserved.
- HDAVI Control™ is a trademark of Panasonic Corporation.
- Windows is a registered trademark of Microsoft Corporation in the United States and other countries.

RealMedia, RealVideo and RealAudio are trademarks or registered trademarks of RealNetworks, Inc.

- These statements are under the Licence Agreement with RealNetworks, Inc.
- 4.4.2.1 Terms of use must prohibit the user from modifying, translating, reverse engineering, decompiling, disassembling or using other means to discover the Source Code or otherwise replicate the functionality of the Client Code, except to the extent that this restriction is expressly prohibited by applicable law.
- 4.4.2.2 Terms of use must effectively disclaim on behalf of Real all warranties and conditions other than those set forth in this Agreement, express and implied, including implied warranties or conditions of merchantability and fitness for a particular purpose; and effectively exclude all liability for indirect, special, incidental and consequential damages, including but not limited to lost profits or replacement systems.

Important Notice

This product is licensed under the AVC patent portfolio license for the personal and non-commercial use of a consumer to (i) encode video in compliance with the AVC Standard ("AVC Video") and/or (ii) decode AVC Video that was encoded by a consumer engaged in a personal and non-commercial activity and/or was obtained from a video provider licensed to provide AVC Video. No license is granted or shall be implied for any other use.

Additional information may be obtained from MPEG LA, LLC.

See <http://www.mpegla.com>.

Panasonic does not guarantee operation and performance of peripheral devices made by other manufacturers; and we disclaim any liability or damage arising from operation and/or performance from usage of such other maker's peripheral devices.

Transport only in upright position

This product incorporates the following software:

- (1) the software developed independently by or for Panasonic Corporation,
- (2) the software owned by third party and licensed to Panasonic Corporation,
- (3) the software licensed under the GNU LESSER GENERAL PUBLIC LICENSE Version 2.1 (LGPL V2.1) and/or,
- (4) open sourced software other than the software licensed under the LGPL V2.1.

The software categorized as (3) and (4) are distributed in the hope that it will be useful, but WITHOUT ANY WARRANTY, without even the implied warranty of MERCHANTABILITY or FITNESS FOR A PARTICULAR PURPOSE.

Please refer to the detailed terms and conditions thereof shown in the "Software Licence" menu on this product.

At least three (3) years from delivery of this product, Panasonic will give to any third party who contacts us at the contact information provided below, for a charge no more than our cost of physically performing source code distribution, a complete machine-readable copy of the corresponding source code covered under LGPL V2.1 or the other licenses with the obligation to do so, as well as the respective copyright notice thereof.

Contact Information: cdrequest@unipf.jp

The source code and the copyright notice are also available for free in our website below.

<http://www.unipf.jp/dl/EUIDTV14/>

Safety Precautions

To help avoid risk of electrical shock, fire, damage or injury, please follow the warnings and cautions below:

■ Mains plug and lead

Warning

If you detect anything unusual, immediately remove the mains plug.

- Mains plug types vary between countries.

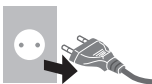

- This TV is designed to operate on:
 - TH-60A430K/TH-60A430G : AC Single 220-240 V, 50 / 60 Hz.
 - TH-60A430M : AC Auto 110-240 V, 50 / 60 Hz.
- Insert the mains plug fully into the socket outlet.
- Ensure that the mains plug is easily accessible.
- Disconnect the mains plug when cleaning the TV.
- Do not touch the mains plug with wet hands.



- Do not damage the mains lead.
 - Do not place a heavy object on the lead.
 - Do not place the lead near a high temperature object.
 - Do not pull on the lead. Hold onto the mains plug body when disconnecting the plug.
 - Do not move the TV with the lead plugged into a socket outlet.
 - Do not twist the lead, bend it excessively or stretch it.
 - Do not use a damaged mains plug or socket outlet.
 - Ensure the TV does not crush the mains lead.
- Do not use any mains lead other than that provided with this TV.



■ Take care

Warning

- Do not remove covers and never modify the TV yourself as live parts are accessible when they are removed. There are no user serviceable parts inside.
- Do not expose the TV to rain or excessive moisture. This TV must not be exposed to dripping or splashing water and objects filled with liquid, such as vases, must not be placed on top of or above the TV.



- Do not insert foreign objects into the TV through the air vents.
- Do not use an unapproved pedestal / mounting equipment. Be sure to ask your local Panasonic dealer to perform the setup or installation of approved wall-hanging brackets.
- Do not apply strong force or impact to the display panel.
- Do not place the TV on sloped or unstable surfaces, and ensure that the TV does not hang over the edge of the base.
- This TV is designed for indoor use.
- This TV is designed for table-top use.
- Do not expose the TV to direct sunlight and other sources of heat.



To prevent the spread of fire, keep candles or other open flames away from this product at all times



■ Dangerous part / Small object

Warning

- This product contains possibly dangerous parts such as plastic bags, that can be breathed in or swallowed by young children accidentally. Keep these parts out of reach of young children.

■ Pedestal

Warning

- Do not disassemble or modify the pedestal.

Caution

- Do not use any pedestal other than the one provided with this TV.
- Do not use the pedestal if it becomes warped or physically damaged. If this occurs, contact your nearest Panasonic dealer immediately.
- During setup, make sure that all screws are securely tightened.
- Ensure that the TV does not suffer any impact during installation of the pedestal.
- Ensure that children do not climb onto the pedestal.
- Install or remove the TV from the pedestal with at least two people.
- Install or remove the TV by the specified procedure.

■ Ventilation

Caution

Allow sufficient space around the TV in order to help prevent excessive heat, which could lead to early failure of some electronic components.

Minimum distance:

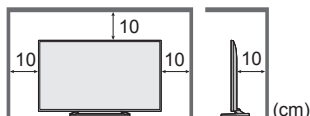

- Ventilation should not be impeded by covering the ventilation openings with items such as newspapers, tablecloths and curtains.
- Whether you are using a pedestal or not, always ensure the vents at the bottom of the TV are not blocked and there is sufficient space to enable adequate ventilation.

■ Moving the TV

Caution

Before moving the TV, disconnect all cables.

- Move the TV with at least two people.

■ When not in use for a long time

Caution

This TV will still consume some power even in the Off mode, as long as the mains plug is still connected to a live socket outlet.

- Remove the mains plug from the wall socket when the TV is not in use for a prolonged period of time.

■ Use conditions

Caution

- This appliance is intended for use in tropical climates.

■ Battery for the Remote Control

Caution

- Incorrect installation may cause battery leakage, corrosion and explosion.
- Replace only with the same or equivalent type.
- Do not mix old and new batteries.
- Do not mix different battery types (such as alkaline and manganese batteries).
- Do not use rechargeable batteries (Ni-Cd, etc.).
- Do not burn or break up batteries.
- Do not expose batteries to excessive heat such as sunshine, fire or the like.
- Make sure you dispose of batteries correctly.
- Remove the battery from the unit when not using for a prolonged period of time to prevent battery leakage, corrosion and explosion.

Accessories

Remote Control

- ➔ (p. 8)
- N2QAYB000825



Pedestal

- ➔ (p. 4, 5)

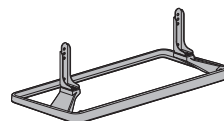

Mains lead

- ➔ (p. 6)

(A430K series)
(A430G series)

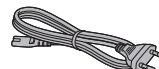

(A430M series)



Batteries (2)

- R6
- ➔ (p. 8)



Operating Instructions

- Accessories may not be placed all together. Take care not to throw them away unintentionally.

Assembling / Removing the pedestal

A Assembly screw (4)



B Assembly screw (4)



C Bracket (2)



D Base

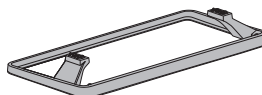

■ Assembling the pedestal

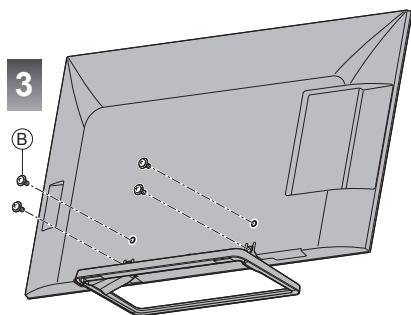
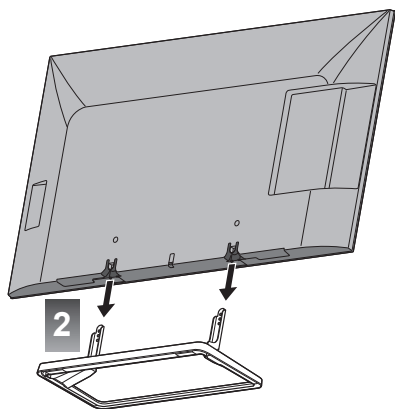
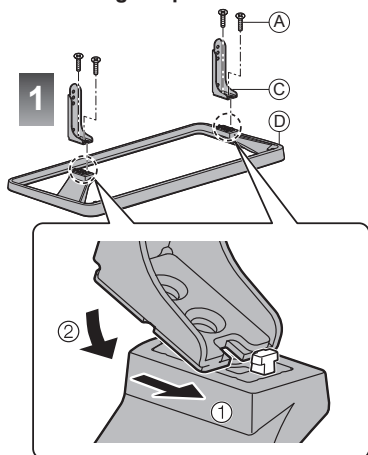

Removing the pedestal from the TV

Be sure to remove the pedestal in the following way when using the wall-hanging bracket or repacking the TV.

- 1 Remove the assembly screws **B** from the TV.
- 2 Lift the TV from the pedestal.
- 3 Remove the assembly screws **A** from the bracket.

Connections

- External equipment and cables shown are not supplied with this TV.
- Please ensure that the unit is disconnected from the mains socket before attaching or disconnecting any cables.
- Check the terminal type and cable plugs are correct when connecting.
- Use a fully wired HDMI compliant cable.
- Keep the TV away from electronic equipment (video equipment, etc.) or equipment with an infrared sensor, otherwise distortion of image / sound may occur or operation of other equipment may be affected.
- Please also read the manual of the equipment being connected.

Terminals

Rear of the TV

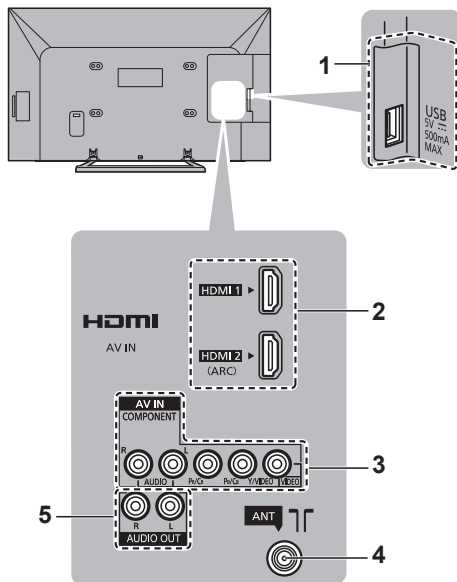

- 1 USB port
- 2 HDMI1 - 2 ➔ (p. 6, 7)
- 3 AV IN (COMPONENT / VIDEO) ➔ (p. 6, 7)
- 4 Aerial terminal ➔ (p. 6)
- 5 AUDIO OUT

Basic connections

■ Mains lead

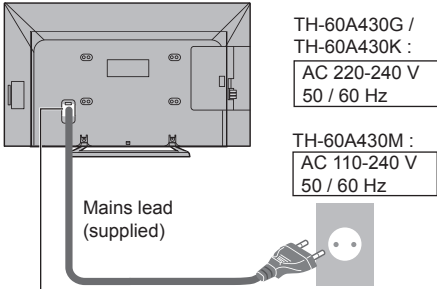

Insert the mains plug firmly into place.

- When disconnecting the mains lead, be absolutely sure to disconnect the mains plug at the socket outlet first.

■ Aerial

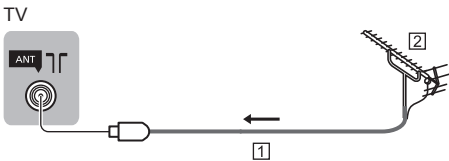

- 1 RF cable
- 2 Aerial

- Keep the space between the TV and RF cable to prevent distorted image.
- Do not put the RF cable close to the mains lead to avoid noise.
- Do not place the RF cable under the TV.
- An aerial, correct cable (75 Ω coaxial) and correct terminating plug are required to obtain optimum quality picture and sound.
- If a communal aerial system is used, you may require the correct connection cable and plug between the wall aerial socket and the TV.
- Your local Television Service Centre or dealer may be able to assist you in obtaining the correct aerial system for your particular area and the accessories required.
- Any matters regarding aerial installation, upgrading of existing systems or accessories required, and the costs incurred, are the responsibility of you, the customer.

AV devices

■ DVD Recorder / VCR

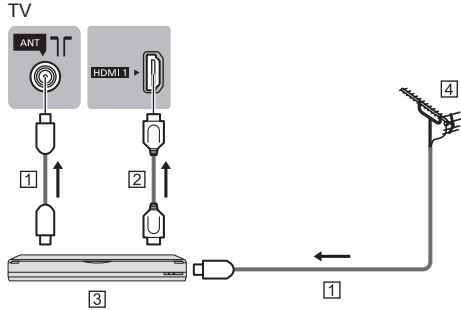

- 1 RF cable
- 2 HDMI cable
- 3 DVD Recorder / VCR
- 4 Aerial

■ Set top box

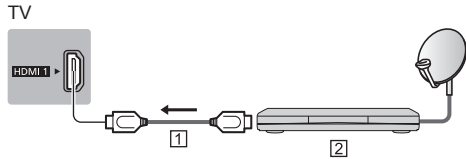

- 1 HDMI cable
- 2 Set top box

Other connections

■ DVD Player

(COMPONENT equipment)

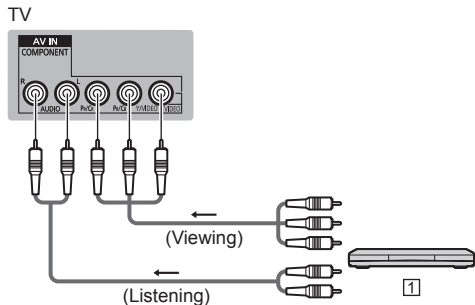

- 1 DVD Player

■ Camcorder / Game equipment

(VIDEO equipment)

TV

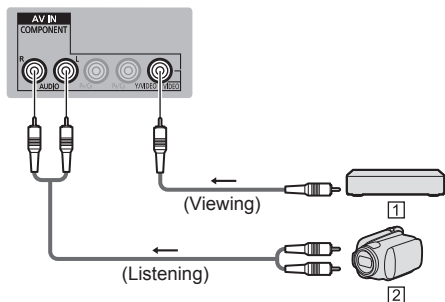

- 1 Game equipment
- 2 Camcorder

■ **Amplifier** (to listen with speakers)

- Use HDMI2 for connecting an amplifier. This connection is applicable when using an amplifier that has ARC (Audio Return Channel) function.

As for an amplifier without ARC function, use AUDIO OUT.

- To enjoy multi-channel sound from external equipment (e.g. Dolby Digital 5.1ch), connect the equipment to the amplifier. For the connections, read the manuals of the equipment and amplifier.

TV

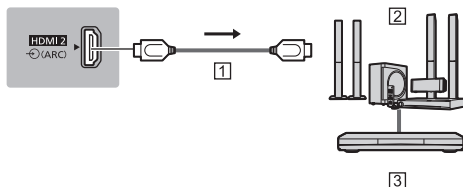

- 1 HDMI cable
- 2 Amplifier with speaker system
- 3 External equipment (DVD Player, etc.)

Identifying Controls

Indicator / Control panel

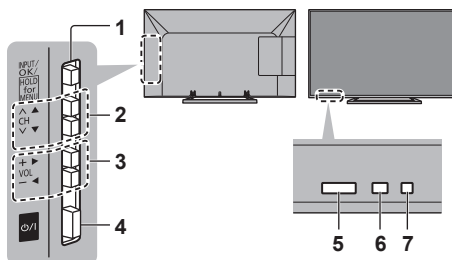

Rear side of the TV

1 Input mode selection

- Press repeatedly until you reach the desired mode.

[Main Menu]

- Press and hold for about 3 seconds to display main menu.

OK (when in the menu system)

2 Channel Up / Down

Cursor Up / Down (when in the menu system)

3 Volume Up / Down

Cursor Left / Right (when in the menu system)

4 Mains power On / Off switch

- Use to switch the mains power.

5 Remote control signal receiver

- Do not place any objects between the TV remote control signal receiver and remote control.

6 Ambient sensor

- Senses brightness to adjust picture quality when [Ambient Sensor] in the Picture Menu is set to [On].

7 Power LED

Red: Standby

Green: On

- The LED blinks when the TV receives a command from the remote control.

Remote Control

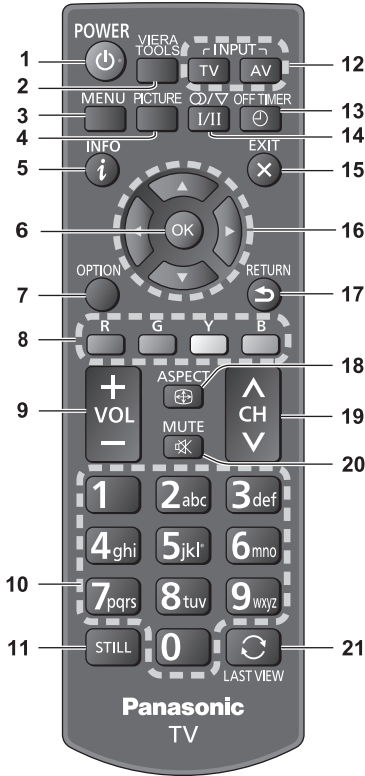

1 Standby On / Off switch

2 VIERA TOOLS

Displays some special icons and accesses easily.



- [VIERA Link] ➔ (p. 16)
- [Photo] in Media Player ➔ (p. 15)
- [Video] in Media Player ➔ (p. 15)
- [Music] in Media Player ➔ (p. 15)
- [Eco Navigation] ➔ (p. 13)

3 [Main Menu]

- Press to access Picture, Sound, Timer, Setup and Help Menus.

4 Picture Selection

- Changes [Viewing Mode].

5 Information

- Displays channel and programme information.

6 OK

- Confirms selections and choices.
- Press after selecting channel positions to quickly change channel.

7 [Option Menu]

- Easy optional setting for viewing, sound, etc.

8 Coloured buttons (red-green-yellow-blue)

- Used for the selection, navigation and operation of various functions.

9 Volume Up / Down

10 Numeric buttons

- Changes channel and teletext pages.
- Sets characters.
- When in Standby mode, switches TV on.

11 Still

- Freezes / unfreezes the picture.

12 Input mode selection

- TV - switches to TV mode.
- AV - switches to AV input mode from Input Selection list.

13 Off Timer

- Sets the period for the TV to turn into standby mode automatically.

14 Changes multiplex sound mode (if available)

- Sound mode indicator:

: STEREO I : MAIN I
 : MONO II : SUB II

15 Exit

- Returns to the normal viewing screen.

16 Cursor buttons

- Makes selections and adjustments.

17 Return

- Returns to the previous menu / page.

18 Aspect

- Changes aspect ratio.

19 Channel Up / Down

20 Sound Mute On / Off

21 Last view

- Switches to previously viewed channel or input mode.

■ Installing / Removing batteries

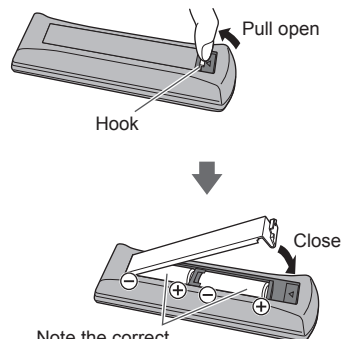

First time Auto Tuning

Automatically sets up the TV and searches for available TV channels when the TV is turned on for the first time.

- These steps are not necessary if the setup has been completed by your local dealer.
- Please complete connections (p. 5 - 7) and settings (if necessary) of the connected equipment before starting Auto Setup. For details of settings for the connected equipment, read the manual of the equipment.

1 Plug the TV into mains socket and turn power on



- Takes a few seconds to be displayed.

2 Select the following items

Set up each item by following the on-screen instructions.

Example:

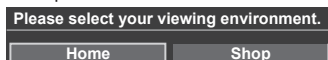

■ How to use remote control



Move the cursor



Access the item / store the setting

RETURN



Return to the previous item

EXIT



Exit the item

Select your language

Select [Home]

Select [Home] viewing environment to use in your home environment.

- [Shop] is for shop display.
- To change viewing environment later on, you will need to initialise all settings by accessing Shipping Condition.

Select your country

Select your area

- When selecting [CATV/Other], press the OK button, and then select the Channel Plan from Indian CATV, South Africa, American System, American CATV or Japan CATV.

Auto Tuning is now complete and your TV is ready for viewing.

Watching External Inputs

Connect the external equipment (VCRs, DVD equipment, etc.) and you can watch through the input.

1 Turn the TV on



When connecting with HDMI

Receives input signals automatically when playback starts.

If input mode is not switched automatically

Perform **2** and **3**

- Check the setup of the equipment.

2 Display the input selection menu



3 Select the input mode connected to the equipment



You can also select the input by pressing the AV button repeatedly.

Child Lock

You can lock specific channels / AV input terminals and control who watches them.

When the locked channel / input is selected, a message appears. Enter the PIN number to watch.

MENU → [Setup] → [Child Lock]

1 Enter the PIN number (4 digits)

- Enter the PIN number twice at first setting.
- Make a note of the PIN number in case you forget it.
- "0000" may be stored as the default PIN number which depends on the country you select.

2 Select [Child Lock List] and set the channel / input to be locked

Child Lock List - TV and AV				
Name	Input	Type	Lock	
101 BBC1 Wales	DVB-C	Free TV		
7 BBC THREE	DVB-T	Free TV	🔒	
14 E4C	DVB-T	Free TV		
VCR	Analogue	Analogue		
1 BBC1	Analogue	Analogue		
2	Analogue	Analogue	🔒	
AV1	External	AV		
AV2	External	AV		



: Appears when the channel / input is locked

To edit the list by using the coloured buttons

- **Lock all:** Locks all channels and input.
- **Unlock all:** Cancels all locks.

■ **To change the PIN number**

Select [Change PIN] and enter a new PIN number twice.

Note

- Setting [Shipping Condition] (p. 13) erases the PIN number and all settings.

Using Menu Functions

1 Display the menu



2 Select the menu

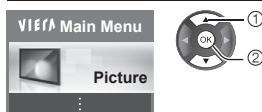

3 Select the item

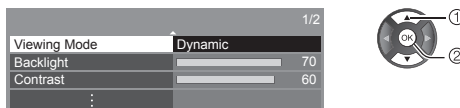

■ Choose from among alternatives

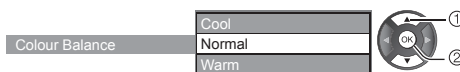

■ Adjust using the slide bar



■ Go to the next screen



Picture

Viewing Mode

Selects your favourite picture mode for each input.

[Dynamic]: Improves contrast and sharpness for viewing in a bright room.

[Normal]: Normal use for viewing in a normal lighting condition.

[Cinema]: Improves the performance of contrast, black and colour reproduction for watching movies in a darkened room.

[True Cinema]: Reproduces the original image quality precisely without any revision.

[Custom]: Adjusts each menu item manually to suit your favourite picture quality.

In each Viewing Mode, [Backlight], [Contrast], [Brightness], [Colour], [Sharpness], [Tint], [Colour Temperature], [Vivid Colour], [Adaptive Backlight Control], [Ambient Sensor], [Noise Reduction] and [MPEG Noise Reduction] can be adjusted and stored for each input.

Backlight / Contrast / Brightness / Colour / Sharpness

Adjusts the levels of these options according to your personal preference.

Tint

Adjusts the picture hue to suit your taste.

- For NTSC signal reception.

Colour Temperature

Selects the colour temperature of the picture.

Vivid Colour

Automatically adjusts colour for a more vivid picture.

Adaptive Backlight Control

Automatically adjusts colour for a more vivid picture.

Ambient Sensor

Automatic Brightness Control function.

Adjusts picture settings automatically depending on ambient lighting conditions.

Noise Reduction

Reduces unwanted picture noise and flicker noise in the contoured parts of a picture.

MPEG Noise Reduction

Reduces MPEG block noise.

Intelligent Frame Creation

Automatically makes the images smooth and clear.

Advanced Settings

Available when you set [Viewing Mode] to [True Cinema] or [Custom].

■ Adaptive Gamma Control

Automatically controls middle level of luminance according to the images.

■ Black Expander

Gradually adjusts the dark shades of the image.

■ White Balance

Adjusts the white balance for red, green and blue signals.

■ Colour Management

Adjusts the hue, saturation and luminance.

■ Gamma

[Gamma]: Switches the gamma curve [2.6] / [2.4] / [2.2] / [2.0] / [1.8].

[Reset to Defaults]: Resets to the default gamma settings in this menu.

■ Reset to Defaults

Resets to the default picture settings in this menu.

Option Settings

■ Game Mode

Provides suitable images for fast response signal when playing games.

- Not valid on TV mode
- To display a continuous record of time spent using [Game Mode] [Playing Time Display] (p. 13)

■ Film Cadence Mode

Improves vertical resolution for movie images.

- This function is available for the interlaced signal.

■ 1080p Pixel Direct

Reproduces the original image quality in detail for 1080p (HDMI) input signal.

■ HDMI Content Type

Adjusts the picture settings of each HDMI input according to the selected content type.

[Auto]: Automatically adjusts the picture settings according to the received HDMI content if the connected equipment supports HDMI Content Type.

- To set the availability of each content type for [Auto] mode, select [Auto Detail Setting].
- For HDMI input.

■ HDMI RGB Range

Adjusts the black level of the image for each HDMI input.

- When the black level is not suitable, select [Full].
- For HDMI input.

■ AV Colour System

Selects optional colour system based on video signals.

- For AV input

■ 3D-COMB

Makes still or slow moving pictures more vivid.

Occasionally, while viewing still or slow moving pictures, colour patterning may be seen. Set to [On] to display sharper and more accurate colours.

- For PAL / NTSC signal reception in TV mode or from composite.

Screen Settings

■ 16:9 Overscan

Selects the screen area displaying the image for 16:9 aspect.

[On]: Enlarges the image to hide the edge of the image.

[Off]: Displays the image in the original size.

- Set to [On] if noise occurs on the edge of the screen.
- This function can be memorised for SD (Standard definition) and HD (High definition) signals respectively.

■ H-Size

Switches over horizontal scanning size.

■ Zoom Adjustments

Adjusts the vertical position and size when the aspect is set to [Just] or [Zoom] mode.

[Just]: V-Size max is 3.

[Zoom]: V-Size max is 15.

■ Screen Display

Turns off / on the TV screen without turning off the TV.

- Sound is active even when the screen is off.
- Press any buttons (except Standby) to turn the screen on.

Copy Adjustment

Copies picture adjustments to other inputs. [Option Settings] and [Screen Settings] are not copied.

■ [Destination Viewing Mode]

Sets the viewing mode for the destination input [True Cinema] / [Custom].

■ [Destination Input]

Selects the destination input.

■ [Copy Start]

Select [Yes] to start copying.

Reset to Defaults

Resets the current Picture Viewing Mode of the selected input to the default settings.

Sound

Mode

Selects your favourite sound mode.

- The selected mode affects all input signals.

[Standard]: Provides the suitable sound quality for all types of scenes.

[Music]: Improves sound quality for watching music videos, etc.

[Speech]: Improves sound quality for watching news, drama, etc.

[User]: Adjusts the sounds manually by using the equaliser to suit your favourite sound quality.

- For the User mode, [Equaliser] will be available in the Sound Menu instead of [Bass] and [Treble]. Select [Equaliser] and adjust the frequency.

Bass

Adjusts level to enhance or minimise lower, deeper sound output.

Treble

Adjusts level to enhance or minimise sharper, higher sound output.

Equaliser

Adjusts the frequency level to suit your favourite sound quality.

- This function is available when [Mode] is set to [User].
- Select the frequency and change the frequency level by using the cursor button.
- To enhance the bass sound, raise the level of the lower frequency. To enhance the treble sound, raise the level of the higher frequency.
- To reset the levels of each frequency to the default settings, select [Reset to Defaults] by using the cursor button.

Balance

Adjusts volume level of right and left speakers.

Surround

Surround sound setting.

Auto Gain Control

Automatically regulates large sound level differences between channels and inputs.

Volume Correction

Adjusts the volume of each individual channel or input mode.

Speaker Distance to Wall

Compensates for the low frequency sound due to the distance between the speakers and the wall.

- If the back space between the TV and wall is within 30 cm, [Up to 30cm] is recommended.
- If the back space between the TV and wall is over 30 cm, [Over 30cm] is recommended.

MPX

Selects multiplex sound mode. (if available)

[Stereo]: Use this normally.

[Mono]: When stereo signal cannot be received.

[M1] / [M2]: Available while mono signal is transmitted.

HDMI Input

Selects to fit the input signal. (p. 18)

[Digital]: When sound is carried via the HDMI cable connection.

[Analogue]: When sound is not carried via the HDMI-DVI adaptor cable connection.

- For HDMI input.

Reset to Defaults

Resets the current [Bass], [Treble], [Balance], [Surround], [Type], and [Visually Impaired] to the default settings.

Timer

Off Timer

Sets the duration of time until the TV automatically goes into Standby mode.

Auto Standby

Sets the duration of time that the TV will remain on when no operation is performed [Off] / [2] / [4] (hours).

- Automatic input switching with the connected equipment affects this function and time-count will be reset.
- The notification message will appear 3 minutes before going into Standby mode.

No signal Power off

Automatically turns the TV to Standby mode to prevent unnecessary power consumption when no signal is received and no operation is performed for 10 minutes.

- The notification message will appear 3 minutes before going into Standby mode.

Setup

Eco Navigation

Sets the TV to operate in the most energy-saving mode.

- You can also access this item by using [VIERA TOOLS].

Child Lock (p. 10)

Tuning Menu (p. 13)

Language

■ OSD Language

Changes language for on-screen displays.

Display Settings

■ Input Labels

Accesses the input labels list to select the label of each input mode or set to skip unconnected one for easier identification and selection in [Input Selection] (p. 9) or banner.

- To skip the input mode, select [Skip].

■ Banner Display Timeout

Sets how long the Information banner stays on screen.

■ Playing Time Display

Set to [On] to display time spent using Game mode on the top right of the screen every 30 minutes.

- This function is available when [Game Mode] (p. 11) is set to [On].

VIERA Link Settings

■ VIERA Link

Sets to use VIERA Link functions [On] / [Off].

■ Power on Link

When an HDMI connected equipment starts playback, the TV is turned on and input mode is switched automatically.

- Only when the TV is in Standby mode.

■ Power off Link

When the TV is set to Standby mode, the HDMI connected equipment is also automatically set to Standby.

■ **Standby Power Save**
Controls the connected equipment to reduce power consumption in Standby.

- This function is available when [VIERA Link] is set to [On] and [Power off Link] is set to [On].

■ Intelligent Auto Standby

Makes non-watched or non-used HDMI connected equipment go into Standby mode to reduce the power consumption.

- This function is available when [VIERA Link] is set to [On].

System Menu

■ Shipping Condition

Resets all settings to the original condition.

■ License Menu

Displays the software licence information.

Other Settings

■ Power Save

Reduces brightness of the picture to economise on power consumption.

Help

■ TV Self Test

Makes a diagnosis of picture or sound problems

- Follow the on-screen instructions.

■ System Information

Displays the system information of this TV.

Tuning and Editing Channels

You can retune channels or make your favourite channel lists, skip unwanted channels, etc.

MENU

➔ [Setup] ➔ [Tuning Menu]

Auto Tuning

Automatically retune all channels received in the area.

[Manual Tuning] (Analogue TV)

Set Analogue TV channel manually after Auto Tuning.



■ **[Fine Tuning]:** Use to make small adjustments to the tuning of an individual channel (affected by weather conditions, etc.)

■ **[Manual Tuning]:** Set Analogue TV channel manually after Auto Tuning.

- Set Sound System and Colour System, and then perform this function. Set Colour System [Auto] normally.
- If a VCR is connected only with the RF cable, select channel position [0].

1 Select the channel position

2 Select the channel

3 Search

4 Select [Store]

Channel List

■ Channel List Edit

You can hide (skip) unwanted channels.

The hidden channels cannot be displayed except in this function.

1 Select a channel and reveal / hide

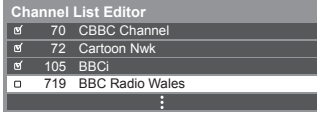

: Reveal

: Hide

2 Edit the channel

- **[Tune]:** To retune each channel (Manual Tuning)
- **[Swap] / [Move]:** To swap / move the channel position (if available)
- **[Reveal all]:** To reveal all channels
- **[Rename]:** To rename the channel (Analogue TV)



backspace



Using Media Player

Media Player allows you to enjoy photo, video or music recorded on a USB Flash Memory.

Photo mode:

Digital photo data will be displayed.

Video mode:

Digital video data will be played back.

- Supported file format ➔ **“Supported file format in Media Player” (p. 18)**
- During the operation, audio signal is output from AV1, AUDIO OUT and HDMI2 (ARC function) terminals. But no video signals are output. To use HDMI2 with ARC function, connect an amplifier that has ARC function.
- The picture may not appear correctly on this TV depending on the recording equipment used.
- Display may take some time when there are many files and folders.
- Partly degraded files might be displayed at a reduced resolution.
- Picture setting may not work depending on the conditions.
- The folder and file names may be different depending on the digital camera or digital video camera used.

Music mode:

Digital music data will be played back.

■ To insert or remove the USB Flash Memory

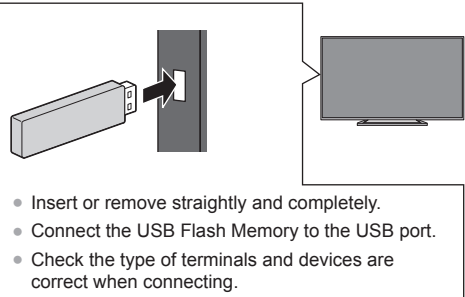

- Insert or remove straightly and completely.
- Connect the USB Flash Memory to the USB port.
- Check the type of terminals and devices are correct when connecting.

1 Insert the USB Flash Memory to the TV

2 Display [VIERA TOOLS] and select the content (Photo / Music / Movie)



- Select the appropriate device and content for playing back each file.

■ To change the contents

While the thumbnail is displayed, display the contents selection.



Photo mode

Example: Thumbnail - [All photos]



[I]: Error display

[Single view] - Photos are displayed one at a time. Select the file from the thumbnail of photos to be viewed.

[Slideshow] - Slideshow completes when all photos are viewed within the current thumbnail.

1 Select the file from the thumbnail of photos for the first view

2 Start Slideshow

- To display / hide the operation guide



■ To sort by folder

1 Display the view selection in the thumbnail view

2 Select [Folder view]

Displays the thumbnail grouped by folder.



Photo Settings

OPTION → [Slideshow Settings]

■ Transition Effect

Selects the transition effect for switching the photo during the slideshow.

■ Screen Mode

Selects enlarged or normal viewing on Single view and Slideshow.

- Depending on the photo size, it may not be fully enlarged to fill the screen, e.g. portrait style picture.

■ Interval

Selects slideshow interval.

■ Repeat

Slideshow repeat.

■ Back Ground Music

Selects the back ground music during Photo mode.

- [Type1 - 3] are the fixed music each installed in this TV.

Note

- Picture quality may become lower depending on the slideshow settings.
- Picture setting may not work depending on the slideshow settings.

Video mode

Example: Thumbnail - [Title view]

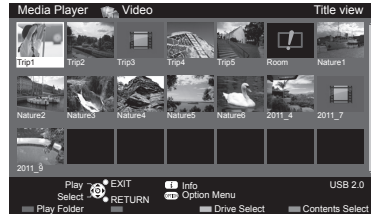

[I]: Error display

[I]: The file does not support thumbnail view

1 Select the title / scene

2 Start playback

- To display / hide the operation guide and information banner
- To change aspect



Video Setup

OPTION → Video Setup Menu

■ [Video Preview]

Sets to start the preview of the title or scene in the thumbnail view [Off] / [On].

■ Repeat

Playback repeat within the selected file (depending on the content).

Music mode

Example: Thumbnail - [Folder view]

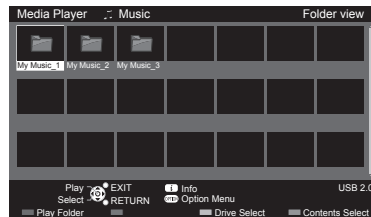

1 Select the folder / file

2 Start playback

- To display / hide the operation guide



Music Setup

OPTION → [Music Setup]

■ Repeat

[Folder]: Playback repeat within the selected folder

[One]: Playback repeat of the selected one file

VIERA Link

VIERA Link "HDAVI Control™"

Enjoy additional HDMI Inter-Operability with Panasonic products which have "HDAVI Control™" function.

VIERA Link (HDAVI Control) connects the TV and the equipment with VIERA Link function, and enables easy control, playback, energy saving, creating home theatre, etc., without complicated settings. Connections to the equipment (DIGA Recorder, HD Video Camera, Player theatre, Amplifier, etc.) with an HDMI cable allow you to interface them automatically (p. 16). These features are limited to models incorporating "HDAVI Control" and "VIERA Link".

- This TV supports "HDAVI Control 5" function. "HDAVI Control 5" is the newest standard for HDAVI Control compatible equipment. This standard is compatible with conventional HDAVI equipment.
- Some functions are not available depending on the equipment's version of HDAVI Control. Confirm the connected equipment's version of HDAVI Control.
- Some functions may not work properly depending on the connected equipment.
- VIERA Link features may be available even with other manufacturers' equipment supporting HDMI CEC.
- VIERA Link "HDAVI Control" is a unique function that we have developed and added based on the control functions provided by HDMI which is an industry standard known as HDMI CEC (Consumer Electronics Control). As such, its operation with other manufacturers' equipment that supports HDMI CEC cannot be guaranteed.
- Please refer to individual manuals for other manufacturers' equipment supporting VIERA Link function.
- About applicable Panasonic equipment, consult your local Panasonic dealer.

Summary of VIERA Link features

■ VIERA Link (HDMI connection)

Connected equipment \ Features	DIGA Recorder	DVD Player / Blu-ray Disc Player	HD Video Camera / LUMIX Camera
Easy playback	○	○	○
Power on Link	○	○	○
Power off Link	○	○	○
Standby Power Save	○*2	○*2	-
Intelligent Auto Standby	○*2	○*2	-
VIERA Link Control	○*1	○*1	○*1

■ VIERA Link (HDMI and Audio out connections)

Connected equipment \ Features	Player theatre	Blu-ray Disc theatre	Amplifier
Easy playback	○*3	○*3	-
Power on Link	○	○	-
Power off Link	○	○	○
Standby Power Save	-	○*2	-
Intelligent Auto Standby	○*2 *4	○*2 *4	○*2
VIERA Link Control	○*1	○*1	-
Speaker Selection	○	○	○

*1: Available with the equipment which has "HDAVI Control 2 or later" function.

*2: Available with the equipment which has "HDAVI Control 4 or later" function.

*3: While playing a disc.

*4: Except for watching a disc.

■ VIERA Link Control of compatible equipment

- Table below displays maximum number of compatible equipment that can be controlled by [VIERA Link Control]. This includes connections to equipment already connected to the TV.

For example, DIGA Recorder connected to Amplifier which is connected to the TV via an HDMI cable.

Type of the equipment	Maximum number
Recorder (DIGA Recorder, etc.)	3
Player (DVD Player, Blu-ray Disc Player, HD Video Camera, LUMIX Camera, Digital Camera, Player theatre, Blu-ray Disc theatre, etc.)	3
Audio system (Player theatre, Blu-ray Disc theatre, Amplifier, etc.)	1
Tuner (Set top box, etc.)	4

Easy playback

Automatic input switching - When the connected equipment is operated, input mode is switched automatically.

- Image or sound may not be available for the first few seconds when input mode is switched.

VIERA Link Control

You can control some functions of the connected equipment with this TV remote control pointing at the TV's signal receiver.

- If you cannot operate, check the settings and the equipment.

1 Display [VIERA TOOLS] and select [VIERA Link]



2 Select [VIERA Link Control]

3 Select the type of the connected equipment to access



[Recorder] / [Player] / [Home Cinema] / [Video Camera] / [LUMIX] / [Digital Camera] / [Other]

- The displayed item may vary depending on the connected equipment.
- [Home Cinema] means Player theatre, Blu-ray Disc theatre or Recorder theatre.
- [Other] means Tuner set top box.

The menu of the accessed equipment will be displayed.

(Input mode will be changed automatically.)

4 Follow the operation guide to operate the menu of the equipment

- To display the operation guide. 
- For details of the operations for the connected equipment, read the manual of the equipment.
- If other manufacturers' equipment is accessed, Setup / Contents Selection menu may be displayed.
- Available VIERA remote control buttons depend on the connected equipment.

Note

- Some operations may not be available depending on the equipment. In this case use its own remote control to operate the equipment.

■ If multiple recorders or players are connected

The number is given from the TV's lower number of HDMI terminal connected to the same type equipment. For example, two recorders to HDMI1 and HDMI2, the recorder connected to HDMI1 is displayed as [Recorder1], and the recorder connected to HDMI2 is displayed as [Recorder2].



[Recorder1-3 / Player1-3]

■ If you access non-VIERA Link equipment

The type of the connected equipment is displayed.

Although you can access the connected equipment, you cannot operate it. Use its own remote control to operate the equipment.

Speaker Selection

You can control the theatre speaker with this TV remote control pointing at the TV's signal receiver.

- If you cannot operate, check the settings and the equipment.

1 Display [VIERA TOOLS] and select [VIERA Link]



2 Select [Speaker Selection]

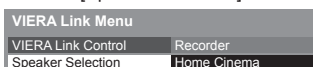

3 Set to [Home Cinema] or [TV]

[Home Cinema]: The sound is from theatre speakers. Player theatre, Blu-ray Disc theatre or Amplifier will be automatically turned on if it is in Standby mode.

- Volume up / down



- Mute



- The sound of TV speakers is mute. When the equipment is turned off, TV speakers will be active.

[TV]: TV speakers are active.

■ Multi-channel sound

If you want to enjoy the multi-channel sound (e.g. Dolby Digital 5.1ch) via an Amplifier, connect it with an HDMI cable and RCA audio cable, and then select [Home Cinema]. If your Amplifier has "HDMI Control 5" function, you only need to connect it with an HDMI cable to the TV's HDMI2 terminal.

To enjoy the sound from the DIGA Recorder in multi-channel sound, connect an HDMI cable from the DIGA Recorder to the Amplifier.

Technical Information

Aspect

Change the aspect ratio (image size)

ASPECT



[16:9]: Directly displays the image at 16:9 without distortion (anamorphic).

[14:9]: Displays the image at the standard 14:9 without distortion.

[Just]: Displays a 4:3 image full-screen. Stretching is only noticeable at the left and right edges.

[4:3]: Displays the image at the standard 4:3 without distortion.

[Zoom]: Displays a 16:9 letterbox or 4:3 image without distortion.

[4:3 Full]: Displays a 4:3 image enlarged horizontally to fit the screen.

- For HD (High definition) signals

[Sidecut Just]

Displays a 16:9 letterbox (anamorphic) image fullscreen. Stretching is only noticeable at the left and right edges.

- For HD (High definition) signals

[Sidecut Zoom]

Displays a 16:9 letterbox (anamorphic) image fullscreen without distortion.

- For HD (High definition) signals

HDMI connection

This TV incorporates HDMI™ technology. HDMI (high-definition multimedia interface) allows you to enjoy high-definition digital images and high-quality sound by connecting the TV and the equipment.

HDMI-compatible equipment*1 with an HDMI or DVI output terminal, such as a DVD player, a set top box or game equipment, can be connected to the HDMI terminal using an HDMI compliant (fully wired) cable.

■ Applicable HDMI features

- Input audio signal: 2ch Linear PCM (sampling frequencies - 48 kHz, 44.1 kHz, 32 kHz)
- Input video signal ➔ **“Input signal that can be displayed” (p. 18)**
Match the output setting of the digital equipment.
- Content Type
- Audio Return Channel*2
(HDMI2 terminal only)

■ DVI connection

If the external equipment has only a DVI output, connect to the HDMI terminal via a DVI to HDMI adaptor cable. When the DVI to HDMI adaptor cable is used, connect the audio cable to AV2 audio terminals.

Note

- Audio settings can be made on [HDMI Input] in the Sound Menu. (p. 12)
 - If the connected equipment has an aspect adjustment function, set the aspect ratio to “16:9”.
 - These HDMI connectors are compatible with HDCP (High-Bandwidth Digital Content Protection) copyright protection.
 - Equipment having no digital output terminal may be connected to the input terminal of component or video to receive analogue signals.
- *1: The HDMI logo is displayed on HDMI-compliant equipment.
- *2: Audio Return Channel (ARC) is a function to send digital sound signals via an HDMI cable.

Input signal that can be displayed

■ COMPONENT (AV) / HDMI terminal

Signal name	COMPONENT	HDMI
525 (480) / 60i, 60p	○	○
625 (576) / 50i, 50p	○	○
750 (720) / 60p, 50p	○	○
1 125 (1 080) / 60i, 50i	○	○
1 125 (1 080) / 60p, 50p, 24p		○

- : Applicable input signal
- Signals other than above may not be displayed properly.
- The above signals are reformatted for optimal viewing on your display.

Supported file format in Media Player

- Some files may not be played back even if they fulfil these conditions.
- Do not use two-byte characters or other special codes for file names.
- Connected devices may become unusable with this TV if the file or folder names are changed.

Photo

- **JPEG** (.jpg / .jpeg)
Image resolution (pixel): 8 × 8 to 30 719 × 17 279
Sub-sampling: 4:4:4, 4:2:2, 4:2:0
- DCF and EXIF standards.
- Progressive JPEG is not supported.

Video

■ AVI (.avi)

Video codec: H.264 BP/MP/HP, MPEG1, MPEG2, MPEG4 SP/ASP, VC-1, Windows Media Video Ver. 9
Audio codec: AAC, ADPCM, Dolby Digital, DTS core, HE-AAC, LPCM, MPEG Audio, MP3, WMA

- Some subtitles or chapter functions may not be available.
- WMA Pro and WMA Lossless are not supported.

■ MKV (.mkv)

Video codec: H.264 BP/MP/HP, MPEG1, MPEG2, MPEG4 SP/ASP

Audio codec: AAC, Dolby Digital, DTS core, HE-AAC, MPEG Audio, MP3, Vorbis

- Some subtitles or chapter functions may not be available.

■ ASF (.asf / .wmv)

Video codec: MPEG4 SP/ASP, VC-1, Windows Media Video Ver. 9

Audio codec: AAC, Dolby Digital, HE-AAC, LPCM, MP3, WMA

- Copy-protected files cannot be played back.
- WMA Pro and WMA Lossless are not supported.

■ MP4 (.f4v / .m4v / .mp4)

Video codec: H.264 BP/MP/HP, MPEG1, MPEG2, MPEG4 SP/ASP

Audio codec: AAC, Dolby Digital, HE-AAC, MPEG Audio, MP3

- This TV supports this container recorded with Panasonic products. For details, read the manual of the products.

■ FLV (.flv)

Video codec: H.264 BP/MP/HP

Audio codec: AAC, MP3

■ 3GPP (.3gp / .3g2)

Video codec: H.264 BP/MP/HP, MPEG4 SP/ASP

Audio codec: AAC, HE-AAC

■ PS (.mod / .mpg / .mpeg / .vob / .vro)

Video codec: H.264 BP/MP/HP, MPEG1, MPEG2, VC-1

Audio codec: AAC, Dolby Digital, HE-AAC, LPCM, MPEG Audio, MP3

■ TS (.mts / .m2ts / .tp / .trp / .ts / .tts)

Video codec: H.264 BP/MP/HP, MPEG1, MPEG2, VC-1

Audio codec: AAC, Dolby Digital, DTS core, HE-AAC, MPEG Audio, MP3

■ RealMedia (.rmvb / .rm)

Video codec: RealVideo 8 (RV30), RealVideo 9 (RV40), RealVideo 10 (RV40)

Audio codec: RealAudio - cook / raac (AAC) / racp (HE-AAC)

Subtitles

■ MicroDVD, SubRip, TMLPlayer (.srt / .sub / .txt)

- The video file and subtitles text file are inside the same folder, and the file names are the same except for the file extensions.
- If there are more than one subtitles text files inside the same folder, they are displayed in the following order of priority: ".srt", ".sub", ".txt".

Music

■ MP3 (.mp3)

■ AAC (.m4a)

- Copy-protected files cannot be played back.

■ WMA (.wma)

- Copy-protected files cannot be played back.
- WMA Pro and WMA Lossless are not supported.

■ LPCM (.wav)

■ FLAC (.flac)

Devices for playing back

■ USB Flash Memory (for playing back in [Media Player])

- USB Flash Memory format:
FAT16, FAT32, exFAT
- USB Flash Memory compliance:
Supports only USB1.1 or USB2.0 standard
USB Hub or card adapter is not supported

Note

- Data modified with a PC may not be displayed.
- Do not remove the device while the TV is accessing data. Otherwise this can damage device or TV.
- Do not touch the pins on the device.
- Do not subject the device to a high pressure or impact.
- Insert the device in the correct direction. Otherwise this can damage device or TV.
- Electrical interference, static electricity, or erroneous operation may damage the data or device.
- Back up the recorded data at regular intervals in case of deteriorated or damaged data or erratic operation of the TV. Panasonic is not liable for any deterioration or damage of recorded data.

USB connection

- It is recommended to connect the USB Flash Memory directly to the TV's USB port.
- Some USB devices or USB HUB may not be used with this TV.
- You cannot connect any devices by using USB card reader.
- Additional information for USB devices may be on the following website. (English only).
<http://panasonic.net/viera/support>

FAQs

Before requesting service or assistance, please follow these simple guides to solve the problem. When an error message appears, follow the message's instructions. If the problem still persists, contact your local Panasonic dealer or the authorised service centre.

Picture quality problem

- Check the settings of the Picture Menu.
 - Set [Noise Reduction] to remove noise (p. 11).
 - Check nearby electrical products (car, motorcycle, fluorescent lamp).
 - Reset channels.
 - Check that the output of the external equipment matches the input of the TV.
-

Sound quality problem

- Check the volume level or sound mute.
 - Check connections and setting of external equipment.
 - Sound signal reception may be deteriorated.
 - Set [MPX] to [Mono] (p. 12).
-

Picture or sound problems with HDMI connection

- Check the HDMI cable is connected properly.
 - Turn the TV and equipment off, then turn them on again.
 - Check an input signal from the equipment.
 - Use equipment compliant with EIA/CEA-861/861D.
 - Set the sound setting of the connected equipment to "2ch L.PCM".
 - Check the [HDMI Input] setting (p. 12).
 - If digital sound connection has a problem, select analogue sound connection.
-

The TV does not switch on

- Check the mains lead is plugged into the TV and the socket outlet.
-

The TV goes into Standby mode

- Auto power standby function is activated.
-

The remote control does not work or is intermittent

- Are the batteries installed correctly? ➔ (p. 8)
 - Has the TV been switched on?
 - The batteries may be running low. Replace them with new ones.
 - Point the remote control directly at the TV's remote control signal receiver (within about 7 m and a 30 degree angle of the signal receiver).
 - Situate the TV away from sunshine or other sources of bright light not to shine on the TV's remote control signal receiver.
-

No image can be displayed

- Check the TV is turned on.
 - Check the mains lead is plugged into the TV and the socket outlet.
 - Check the correct input mode is selected.
 - Check the settings of the Picture Menu.
 - Check all required cables and connections are firmly in place.
-

Unusual image is displayed

- Turn the TV off with Mains power On / Off switch, then turn it on again.
 - If the problem persists, initialise all settings.
➔ [Shipping Condition] (p. 13)
-

There may be red, blue, green and black spots on the screen

- This is a characteristic of liquid crystal panels and is not a problem. The liquid crystal panel is built with very high precision technology giving you fine picture details. Occasionally, a few non-active pixels may appear on the screen as a fixed point of red, green, blue or black. Please note this does not affect the performance of your LCD.
-

Parts of the TV become hot

- Even if the temperature of parts of the front, top and rear panels has risen, these temperature rises do not cause any problems in terms of performance or quality.
-

The LCD panel moves slightly and clattered sound is heard when it is pushed with a finger

- There is a little gap around the panel to prevent damage to the panel. This is not a malfunction.
-

Overcurrent error message appears

- The connected USB device might cause this error. Remove the device and turn the TV to standby mode with Standby On / Off switch, then turn it on again.
 - Check foreign objects are not inside the USB port.
-

Maintenance

First, remove the mains plug from the socket outlet.

Display panel, Cabinet, Pedestal

Regular care:

Gently wipe the surface of the display panel, cabinet, or pedestal by using a soft cloth to clean the dirt or fingerprints.

For stubborn dirt:

- (1) First clean the dust on the surface.
- (2) Dampen a soft cloth with clean water or diluted neutral detergent (1 part detergent to 100 parts water).
- (3) Wring the cloth firmly. (Please note liquids do not enter the TV inside. May lead to product failure.)
- (4) Finally, wipe away all the moisture.

Caution

- Do not use a hard cloth or rub the surface too hard, otherwise this may cause scratches on the surface.
- Take care not to subject the surfaces to insect repellent, solvent, thinner or other volatile substances. This may degrade surface quality or cause peeling of the paint.
- The surface of the display panel is specially treated and may be easily damaged. Take care not to tap or scratch the surface with your fingernail or other hard objects.
- Do not allow the cabinet and pedestal to make contact with a rubber or PVC substance for a long time. This may degrade surface quality.

Mains plug

Wipe the mains plug with a dry cloth at regular intervals. Moisture and dust may cause fire or electrical shock.

Specifications

■ TV

Model Name

TH-60A430G
TH-60A430K
TH-60A430M

Dimensions (W × H × D)

1 351 mm × 822 mm × 289 mm (With Pedestal)
1 351 mm × 778 mm × 62 mm (TV only)

Mass

21.0 kg Net (With Pedestal)
19.5 kg Net (TV only)

Power source

TH-60A430G / TH-60A430K
AC Single 220-240 V, 50 / 60 Hz
TH-60A430M
AC Auto 110-240 V, 50 / 60 Hz

Rated power consumption

TH-60A430G / TH-60A430K
166 W
TH-60A430M
172 W

Standby power consumption

0.20 W

Visible screen size (diagonal)

151 cm

Display resolution

1 920 (W) × 1 080 (H)

Panel

LED backlight Liquid Crystal Display

Sound

Speaker output

20 W (10 W + 10 W)

Connection terminals

AV IN (COMPONENT / VIDEO)

VIDEO

RCA PIN Type × 1
1.0 V[p-p] (75 Ω)

AUDIO L - R

RCA PIN Type × 2
0.5 V[rms]

Y

1.0 V[p-p] (including synchronisation)

P_B/C_B, P_R/C_R

±0.35 V[p-p]

HDMI 1 / 2 input

TYPE A Connectors

HDMI1: Content Type

HDMI2: Content Type, Audio Return Channel

- This TV supports "HDMI Control 5" function.

USB Port

DC 5 V, Max. 500 mA [Hi-Speed USB (USB 2.0)]

AUDIO OUT

AUDIO L - R

RCA PIN Type × 2

0.5 V[rms]

Receiving systems / Band name

17 Systems		Function
1	PAL B, G, H	Reception of broadcast transmissions and Playback from Video Cassette Tape Recorders
2	PAL I	
3	PAL D, K	
4	SECAM B, G	
5	SECAM D, K	
6	SECAM K1	
7	NTSC M (NTSC 3.58/4.5 MHz)	
8	NTSC 4.43/5.5 MHz	Playback from Special VCR's or DVD
9	NTSC 4.43/6.0 MHz	
10	NTSC 4.43/6.5 MHz	
11	NTSC 3.58/5.5 MHz	
12	NTSC 3.58/6.0 MHz	
13	NTSC 3.58/6.5 MHz	
14	SECAM I	
15	PAL 60 Hz/5.5 MHz	Playback from Special Disc Players and Special VCR's or DVD (via AV input only)
16	PAL 60 Hz/6.0 MHz	
17	PAL 60 Hz/6.5 MHz	

Receiving channels (Analogue TV)

VHF BAND

2-12 (PAL/SECAM B, K1)

0-12 (PAL B AUST.)

1-9 (PAL B N.Z.)

1-12 (PAL/SECAM D)

1-12 (NTSC M Japan)

2-13 (NTSC M USA)

UHF BAND

21-69 (PAL G, H, I/SECAM G, K, K1)

28-69 (PAL B AUST.)

13-57 (PAL D, K)

13-62 (NTSC M Japan)

14-69 (NTSC M USA)

CATV

S1-S20 (OSCAR)

1-125 (USA CATV)

C13-C49 (JAPAN)

S21-S41 (HYPER)

Z1-Z37 (CHINA)

5A, 9A (AUST.)

Aerial input

VHF / UHF

Operating conditions

Temperature

0 °C - 40 °C

Note

- Design and Specifications are subject to change without notice. Mass and Dimensions shown are approximate.

■ When using the wall-hanging bracket

- Please contact your local Panasonic dealer to purchase the recommended wall-hanging bracket.
- Holes for wall-hanging bracket installation.

Rear of the TV

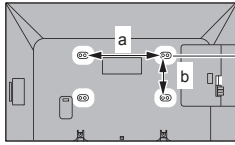

a: 400 mm

b: 200 mm

(View from the side)

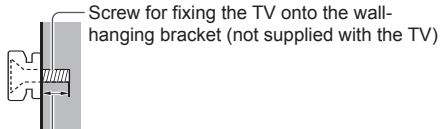

Depth of screw

minimum: 10 mm

maximum: 20 mm

Diameter : M6

Warning

- Using other wall-hanging brackets, or installing a wall-hanging bracket by yourself have the risk of personal injury and product damage. In order to maintain the unit's performance and safety, be absolutely sure to ask your dealer or a licensed contractor to secure the wall-hanging brackets. Any damage caused by installing without a qualified installer will void your warranty.
- Carefully read the instructions accompanying the wall-hanging bracket, and be absolutely sure to take steps to prevent the TV from falling off.
- Handle the TV carefully during installation since subjecting it to impact or other forces may cause product damage.
- Do not mount the unit directly below ceiling lights (such as spotlights or halogen lights) which typically give off high heat. Doing so may warp or damage plastic cabinet parts.
- Take care when fixing wall brackets to the wall. Always ensure that there are no electrical cables or pipes in the wall before hanging bracket.
- To prevent fall and injury, remove the TV from its fixed wall position when it is no longer in use.

Information on Disposal in other Countries outside the European Union



This symbol is only valid in the European Union. If you wish to discard this product, please contact your local authorities or dealer and ask for the correct method of disposal.



Customer's Record

The model number and serial number of this product may be found on its rear panel. You should note this serial number in the space provided below and retain this book, plus your purchase receipt, as a permanent record of your purchase to aid in identification in the event of theft or loss, and for Warranty Service purposes.

Model Number

Serial Number

Panasonic Corporation

Web Site: <http://panasonic.net>

English