

# Panasonic®

English

TH-32AS610G TH-50AS610K  
TH-32AS610M TH-50AS610G  
TH-42AS610K TH-50AS610M  
TH-42AS610G  
TH-42AS610M

## Operating Instructions LED TV

32-inch model



42-inch model

50-inch model

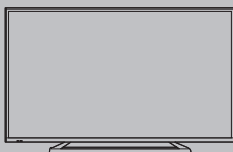

# VIERA

For more detailed instructions, refer to [eHELP]  
(Built-in Operating Instructions).

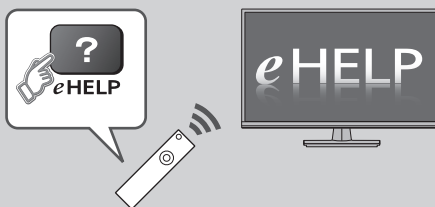

- How to use [eHELP] → (p. 12)

Thank you for purchasing this Panasonic product.

Please read these instructions carefully before operating this product and retain them for future reference.

The images shown in this manual are for illustrative purposes only.

M0214-1034



TQB4GC1205-1

English



(AS610K series)  
(AS610M series)



- For the information of the trademarks, refer to [eHELP] (Support > Licence).

The illustration for TH-32AS610G is used in this manual unless otherwise mentioned. Illustrations shown may be different depending on the model.

## Contents

### Be Sure to Read

Important Notice	2
Safety Precautions	3

### Quick Start Guide

Accessories	5
Connections	6
Identifying Controls	9
First time Auto Tuning	10

### Using your VIERA

Operations	11
How to Use eHELP	12

### Others

FAQs	13
Maintenance	13
Specifications	14

## Important Notice

Panasonic does not guarantee operation and performance of peripheral devices made by other manufacturers; and we disclaim any liability or damage arising from operation and/or performance from usage of such other maker's peripheral devices.

The recording and playback of content on this or any other device may require permission from the owner of the copyright or other such rights in that content. Panasonic has no authority to and does not grant you that permission and explicitly disclaims any right, ability or intention to obtain such permission on your behalf. It is your responsibility to ensure that your use of this or any other device complies with applicable copyright legislation in your country. Please refer to that legislation for more information on the relevant laws and regulations involved or contact the owner of the rights in the content you wish to record or playback.

This product is licensed under the AVC patent portfolio license for the personal and non-commercial use of a consumer to (i) encode video in compliance with the AVC Standard ("AVC Video") and/or (ii) decode AVC Video that was encoded by a consumer engaged in a personal and non-commercial activity and/or was obtained from a video provider licensed to provide AVC Video. No license is granted or shall be implied for any other use.

Additional information may be obtained from MPEG LA, LLC.

See <http://www.mpegla.com>.

Panasonic and its affiliates make no representations or warranties of any kind with respect to the USB devices and the performance of communication between the USB devices and the USB port of Panasonic products, and expressly disclaims any and all warranties, whether express or implied or otherwise, including without limitation any implied warranty of fitness for a particular purpose, any loss of data, and any implied warranties arising from course of dealing or course of performance of data communication between the USB devices and the USB port of Panasonic products.

Transport only in upright position.

# Safety Precautions

To help avoid risk of electrical shock, fire, damage or injury, please follow the warnings and cautions below:

## ■ Mains plug and lead

### Warning

If you detect anything unusual, immediately remove the mains plug.

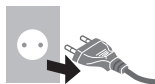

- Mains plug types vary between countries.

- This TV is designed to operate on:
  - AS610G series: AC Single 220-240 V, 50 / 60 Hz.
  - AS610K series: AC Single 220-240 V, 50 / 60 Hz.
  - AS610M series: AC Auto 110-240 V, 50 / 60 Hz.

- Insert the mains plug fully into the socket outlet.
- Ensure that the mains plug is easily accessible.
- Disconnect the mains plug when cleaning the TV.

- Do not touch the mains plug with wet hands.



- Do not damage the mains lead.

- Do not place a heavy object on the lead.



- Do not place the lead near a high temperature object.



- Do not pull on the lead. Hold onto the mains plug body when disconnecting the plug.



- Do not move the TV with the lead plugged into a socket outlet.

- Do not twist the lead, bend it excessively or stretch it.

- Do not use a damaged mains plug or socket outlet.
- Ensure the TV does not crush the mains lead.

- Do not use any mains lead other than that provided with this TV.

## ■ Take care

### Warning

- Do not remove covers and never modify the TV yourself as live parts are accessible when they are removed. There are no user serviceable parts inside.



- Do not expose the TV to rain or excessive moisture. This TV must not be exposed to dripping or splashing water and objects filled with liquid, such as vases, must not be placed on top of or above the TV.



- Do not insert foreign objects into the TV through the air vents.
- Do not use an unapproved pedestal / mounting equipment. Be sure to ask your local Panasonic dealer to perform the setup or installation of approved wall-hanging brackets.

- Do not apply strong force or impact to the display panel.

- Do not place the TV on sloped or unstable surfaces, and ensure that the TV does not hang over the edge of the base.



- This TV is designed for table-top use.

- Do not expose the TV to direct sunlight and other sources of heat.



**To prevent the spread of fire, keep candles or other open flames away from this product at all times**



## ■ Dangerous part / Small object

### Warning

- This product contains possibly dangerous parts such as plastic bags, that can be breathed in or swallowed by young children accidentally. Keep these parts out of reach of young children.

## ■ Pedestal

### Warning

- Do not disassemble or modify the pedestal.

### Caution

- Do not use any pedestal other than the one provided with this TV.
- Do not use the pedestal if it becomes warped or physically damaged. If this occurs, contact your nearest Panasonic dealer immediately.
- During setup, make sure that all screws are securely tightened.
- Ensure that the TV does not suffer any impact during installation of the pedestal.
- Ensure that children do not climb onto the pedestal.
- Install or remove the TV from the pedestal with at least two people.
- Install or remove the TV by the specified procedure.

## ■ Radio wave

### Warning

- Do not use the TV in any medical institutions or locations with medical equipment. Radio waves may interfere with the medical equipment and cause accidents due to the malfunction.
- Do not use the TV near any automatic control equipment such as automatic doors or fire alarms. Radio waves may interfere with the automatic control equipment and cause accidents due to the malfunction.
- Keep the distance at least 22 cm from the TV when you have a cardiac pacemaker. Radio waves may interfere with the operation of the pacemaker.
- Do not disassemble or alter the TV in any way.

## ■ Built-in wireless LAN

### Caution

- Do not use the built-in wireless LAN to connect to any wireless network (SSID\*) for which you do not have usage rights. Such networks may be listed as a result of searches. However, using them may be regarded as illegal access.  
\*SSID is a name for identifying a particular wireless network for transmission.
- Do not subject the built-in wireless LAN to high temperatures, direct sunlight or moisture.
- Data transmitted and received over radio waves may be intercepted and monitored.
- The built-in wireless LAN uses 2.4 GHz and 5 GHz frequency bands. To avoid malfunctions or slow response caused by radio wave interference, keep the TV away from the devices such as other wireless LAN devices, microwaves, mobile phones and the devices that use 2.4 GHz and 5 GHz signals when using the built-in wireless LAN.
- When noises occur due to the static electricity, etc., the TV might stop operating for the protection of the devices. In this case, turn the TV off with Mains power On / Off switch, then turn it on again.
- Additional information for the wireless LAN and access point may be on the following website.  
(English only)  
<http://panasonic.net/viera/support>

## ■ Ventilation

### Caution

Allow sufficient space around the TV in order to help prevent excessive heat, which could lead to early failure of some electronic components.

Minimum distance:

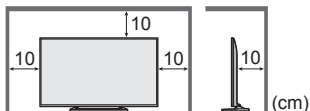

- Ventilation should not be impeded by covering the ventilation openings with items such as newspapers, tablecloths and curtains.
- Whether you are using a pedestal or not, always ensure the vents at the bottom of the TV are not blocked and there is sufficient space to enable adequate ventilation.



## ■ Moving the TV

### Caution

Before moving the TV, disconnect all cables.

42-inch model 50-inch model

- Move the TV with at least two people. Support as shown to avoid injury by the TV tipping or falling.



## ■ When not in use for a long time

### Caution

This TV will still consume some power even in the Off mode, as long as the mains plug is still connected to a live socket outlet.

- Remove the mains plug from the wall socket when the TV is not in use for a prolonged period of time.

## ■ Use conditions

### Caution

- This appliance is intended for use in tropical climates.

## ■ Battery for the Remote Control

### Caution

- Incorrect installation may cause battery leakage, corrosion and explosion.
- Replace only with the same or equivalent type.
- Do not mix old and new batteries.
- Do not mix different battery types (such as alkaline and manganese batteries).
- Do not use rechargeable batteries (Ni-Cd, etc.).
- Do not burn or break up batteries.
- Do not expose batteries to excessive heat such as sunshine, fire or the like.
- Make sure you dispose of batteries correctly.
- Remove the battery from the unit when not using for a prolonged period of time to prevent battery leakage, corrosion and explosion.

# Accessories

## Remote Control

- ➔ (p. 9)
- N2QAYB000834



## Pedestal

- ➔ (p. 5, 6)

32-inch model

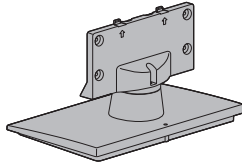

42-inch model

50-inch model

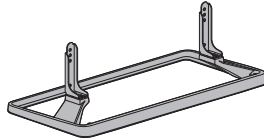

## Mains lead

- ➔ (p. 7)

(AS610G series)  
(AS610K series)

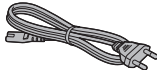

(AS610M series)



## Batteries (2)

- R6
- ➔ (p. 9)



## Operating Instructions

Accessories may not be placed all together. Take care not to throw them away unintentionally.

- For the information of optional accessories, refer to [eHELP] (Support > Optional accessories).

## Assembling / Removing the pedestal

### A Assembly screw (3)



### B Assembly screw (4)



M4 × 15

### C Bracket

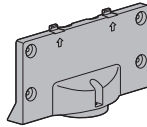

### D Base

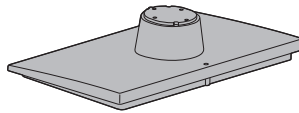

### ■ Assembling the pedestal

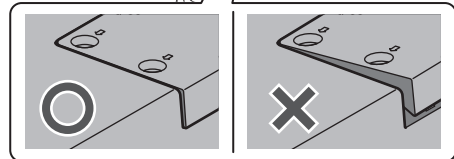
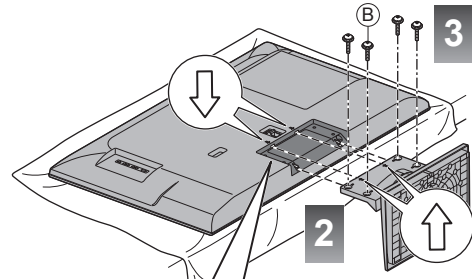
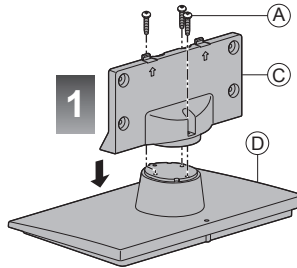

42-inch model 50-inch model

**(A) Assembly screw (4)**



**(B) Assembly screw (4)**



**(C) Bracket (2)**



**(D) Base**

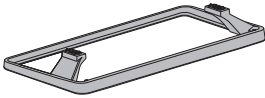

**■ Assembling the pedestal**

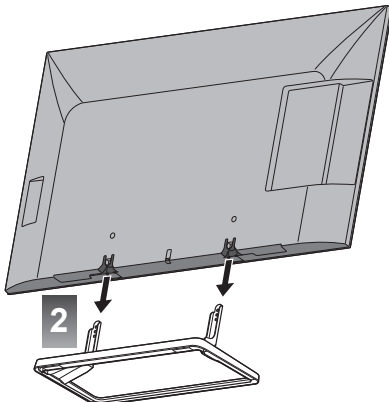
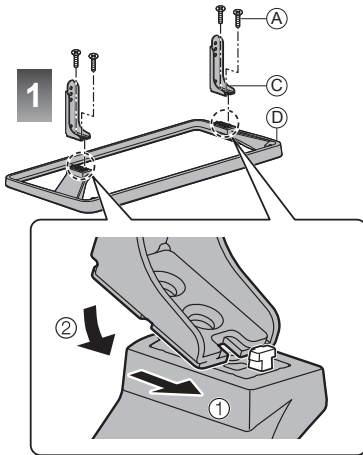

**3**

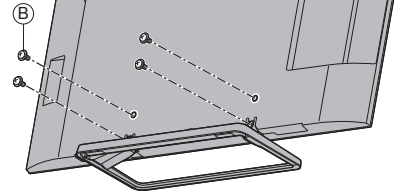

**■ Removing the pedestal from the TV**

Be sure to remove the pedestal in the following way when using the wall-hanging bracket or repacking the TV.

- 1 Remove the assembly screws (B) from the TV.
- 2 Pull out the pedestal from the TV.
- 3 Remove the assembly screws (A) from the bracket.

## Connections

- External equipment and cables shown are not supplied with this TV.
- Please ensure that the unit is disconnected from the mains socket before attaching or disconnecting any cables.
- Check the terminal type and cable plugs are correct when connecting.
- Use a fully wired HDMI compliant cable.
- Keep the TV away from electronic equipment (video equipment, etc.) or equipment with an infrared sensor, otherwise distortion distortion of image / sound may occur or operation of other equipment may be affected.
- Please also read the manual of the equipment being connected.

## Terminals

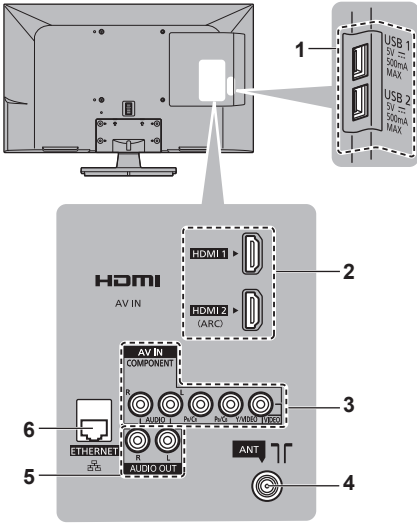

- 1 USB 1 - 2 port
- 2 HDMI1 - 2 ➔ (p. 7, 8)
- 3 AV (COMPONENT / VIDEO) ➔ (p. 8)
- 4 Aerial terminal ➔ (p. 7)
- 5 AUDIO OUT
- 6 ETHERNET ➔ (p. 8)

## Basic connections

### ■ Mains lead

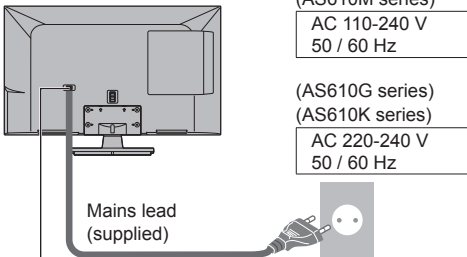

Insert the mains plug firmly into place.

32-inch model

42-inch model

50-inch model

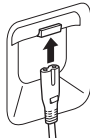
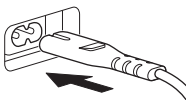

- When disconnecting the mains lead, be absolutely sure to disconnect the mains plug at the socket outlet first.

### ■ Aerial

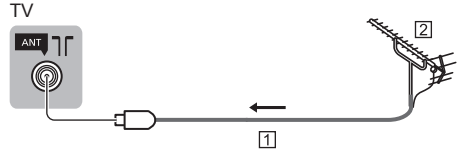

- 1 RF cable
- 2 Aerial
  - Keep the space between the TV and RF cable to prevent distorted image.
  - Do not put the RF cable close to the mains lead to avoid noise.
  - Do not place the RF cable under the TV.
  - An aerial, correct cable (75 Ω coaxial) and correct terminating plug are required to obtain optimum quality picture and sound.
  - If a communal aerial system is used, you may require the correct connection cable and plug between the wall aerial socket and the TV.
  - Your local Television Service Centre or dealer may be able to assist you in obtaining the correct aerial system for your particular area and the accessories required.
  - Any matters regarding aerial installation, upgrading of existing systems or accessories required, and the costs incurred, are the responsibility of you, the customer.

## AV devices

### ■ DVD Recorder / VCR

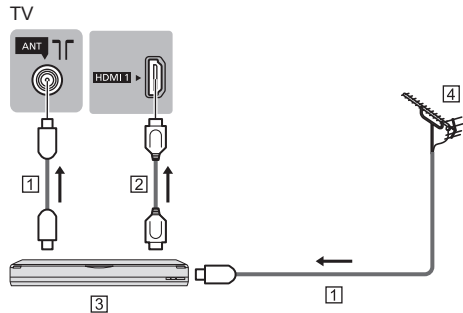

- 1 RF cable
- 2 HDMI cable
- 3 DVD Recorder / VCR
- 4 Aerial

## ■ Set top box

TV

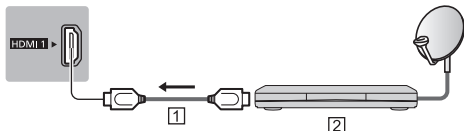

- 1 HDMI cable
- 2 Set top box

## Network

To use internet service, you need a broadband network environment.

- If you do not have any broadband network services, please consult your retailer for assistance.
- Prepare the internet environment for wired connection or wireless connection.
- Setup of the network connection will start when first using the TV. ➔ (p. 10)

### ■ Wired connection

TV

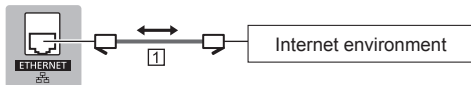

- 1 LAN cable (Shielded)
  - Use the Shielded Twist Pair (STP) LAN cable.

### ■ Wireless connection



- 1 Built-in wireless LAN
- 2 Access point

## Other connections

### ■ DVD Player

(COMPONENT equipment)

TV

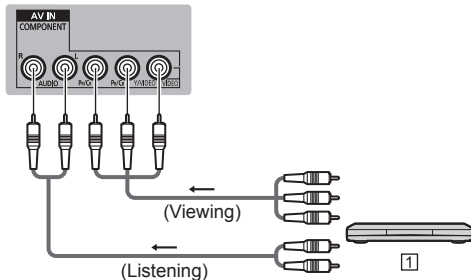

- 1 DVD Player

### ■ Camcorder / Game equipment

(VIDEO equipment)

TV

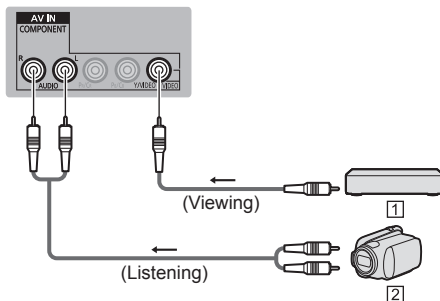

- 1 Game equipment
- 2 Camcorder

### ■ Amplifier (to listen with speakers)

- Use HDMI2 for connecting an amplifier. This connection is applicable when using an amplifier that has ARC (Audio Return Channel) function.

As for an amplifier without ARC function, use AUDIO OUT.

- To enjoy multi-channel sound from external equipment (e.g. Dolby Digital 5.1ch), connect the equipment to the amplifier. For the connections, read the manuals of the equipment and amplifier.
- To select the sound output
  - ➔ [TV Speaker] in the Sound Menu

TV

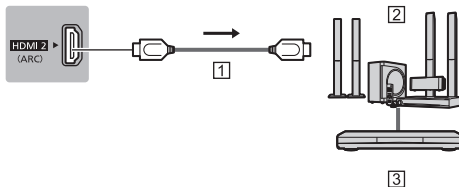

- 1 HDMI cable
- 2 Amplifier with speaker system
- 3 External equipment (DVD Player, etc.)

### ■ Communication Camera

- Use USB 1 for connecting the Communication Camera.
- For more information, refer to [eHELP] (Support > Optional accessories > Communication Camera).

### ■ VIERA Link

- Use HDMI1 - 2 for VIERA Link connection.
- For more information, refer to [eHELP] (Functions > VIERA Link "HDAVI Control™").



# Identifying Controls

## Remote Control

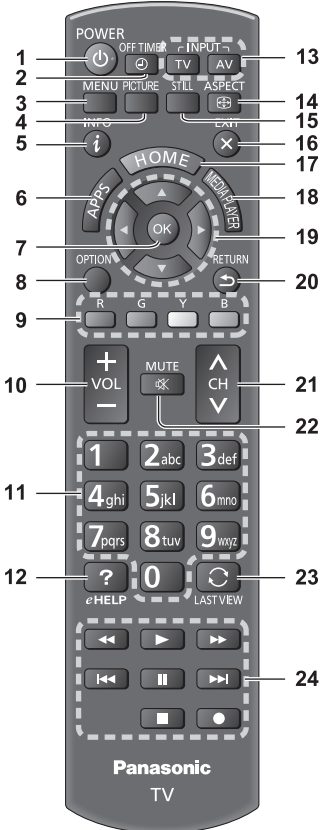

- 1 Standby On / Off switch**
- 2 Off Timer**
  - Sets the time for the TV to automatically turn off.
- 3 [Main Menu]**
  - Press to access Picture, Sound, Network, Timer, Setup and Help Menus.
- 4 Picture Selection**
  - Changes [Viewing Mode].
- 5 Information**
  - Displays channel and programme information.
- 6 APPS**
  - Displays [APPS List] (applications list).
- 7 OK**
  - Confirms selections and choices.
  - Press after selecting channel positions to quickly change channel.
  - Displays channel list.

- 8 [Option Menu]**
  - Easy optional setting for viewing, sound, etc.
- 9 Coloured buttons (red-green-yellow-blue)**
  - Used for the selection, navigation and operation of various functions.
- 10 Volume Up / Down**
- 11 Numeric buttons**
  - Changes channel and teletext pages.
  - Sets characters.
  - When in Standby mode, switches TV on.
- 12 [eHELP]**
  - Displays [eHELP] (Built-in Operating Instructions).
- 13 Input mode selection**
  - TV - switches to TV mode.
  - AV - switches to AV input mode from Input Selection list.
- 14 Aspect**
  - Changes aspect ratio.
- 15 Still**
  - Freezes / unfreezes picture.
- 16 Exit**
  - Returns to [Home Screen].
- 17 HOME**
  - Displays [Home Screen].
- 18 MEDIA PLAYER**
  - Switches to USB device viewing / listening mode.
- 19 Cursor buttons**
  - Makes selections and adjustments.
- 20 Return**
  - Returns to the previous menu / page.
- 21 Channel Up / Down**
- 22 Sound Mute On / Off**
- 23 Last view**
  - Switches to previously viewed channel or input mode.
- 24 Operations for contents, connected equipment, etc.**

### ■ Installing / Removing batteries

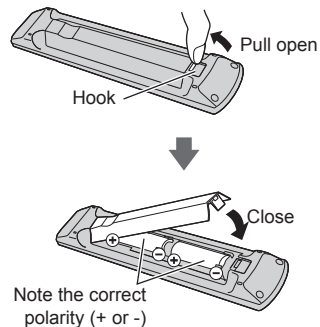

## Indicator / Control panel

- When pressing 1, 2, 3 buttons, the control panel guide appears on the right side of the screen for 3 seconds to highlight the pressed button.

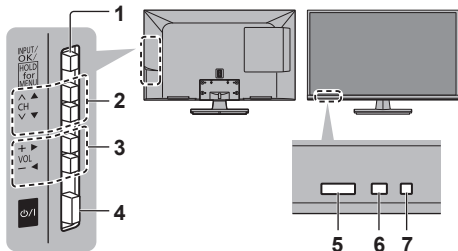

Rear side of the TV

### 1 Input mode selection

- Press repeatedly until you reach the desired mode.

#### [Main Menu]

- Press and hold for about 3 seconds to display main menu.

#### OK (when in the menu system)

### 2 Channel Up / Down

Cursor Up / Down (when in the menu system)

### 3 Volume Up / Down

Cursor Left / Right (when in the menu system)

### 4 Mains power On / Off switch

- Use to switch the mains power.

### 5 Remote control signal receiver

- Do not place any objects between the TV remote control signal receiver and remote control.

### 6 Ambient sensor

- Senses brightness to adjust picture quality when [Ambient Sensor] in the Picture Menu is set to [On].

### 7 Power LED

**Red:** Standby

**Green:** On

- The LED blinks when the TV receives a command from the remote control.

# First time Auto Tuning

Automatically sets up the TV and searches for available TV channels when the TV is turned on for the first time.

- These steps are not necessary if the setup has been completed by your local dealer.
- Please complete connections (p. 7 - 8) and settings (if necessary) of the connected equipment before starting Auto Tuning. For details of settings for the connected equipment, read the manual of the equipment.

## 1 Plug the TV into mains socket and turn power on

POWER

- Takes a few seconds to be displayed.



## 2 Select the following items

Set up each item by following the on-screen instructions.

Example:

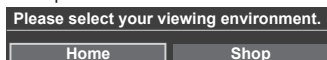

### How to use remote control



Move the cursor



Access the item / store the setting

RETURN



Return to the previous item (if available)

### Select the following items

Set up each item by following the on-screen instructions.

#### Select your language

#### Select [Home]

Select [Home] viewing environment to use in your home environment.

- [Shop] is for shop display.
- To change viewing environment later on, you will need to initialise all settings by accessing Shipping Condition.

#### Set up the network connection

#### Select your country

### Select your area

- When selecting [CATV/Other], press the OK button, and then select the Channel Plan from Indian CATV, South Africa, American System, American CATV or Japan CATV.

## 3 Select the type of [Home Screen]

The demonstration to explain how to use [my Home Screen] is displayed. Confirm the demonstration by following the on-screen instructions, and then select the desired [Home Screen].

Example: [Home Screen Selection]



Example: [TV Home Screen]



### Auto Tuning is now complete and your TV is ready for viewing.

If tuning has failed, check the connection of the network, RF cable, and then follow the on-screen instructions.

#### Note

- The TV will automatically go into Standby mode when no operation is performed for 4 hours if [Auto Standby] in the Timer Menu is set to [On].
- The TV will automatically go into Standby mode when no signal is received and no operation is performed for 10 minutes if [No signal Power off] in the Timer Menu is set to [On].
- To retune all channels  
➔ [Auto Tuning] in [Tuning Menu] (Setup Menu)
- To add the available TV signal mode later  
➔ [Add TV Signal] in [Tuning Menu] (Setup Menu)
- To initialise all settings  
➔ [Shipping Condition] in [System Menu] (Setup Menu)

# Operations

## Turn power on

(TV)

or  
POWER



(Remote Control)

- Mains power On / Off switch should be on. (p. 10)

The last viewed [Home Screen] is displayed.

Example: [TV Home Screen]



Example: Selected content screen



- To return to [Home Screen] at any time



- You can set up or make [Home Screen] to display desired information, to access specific features easily, to select the default [Home Screen], etc. For details, follow the on-screen instructions or refer to [eHELP] (my Home Screen > my Home Screen).

## Watching TV

### 1 Select the TV viewer from [Home Screen]



- select
- access

### 2 Select TV mode

TV

### 3 Select a channel

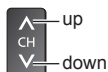

or



- To select two-digit channel position number, e.g. 39



### To access each feature

Access [APPS List] and select a feature



Example: [APPS List]



- APPS is the applications (features) of the TV.
- For operations of each feature and the setup of [APPS List], follow the on-screen instructions or refer to [eHELP] (my Home Screen > APPS List).

## How to Use eHELP

[eHELP] is the detailed operating instructions built into the TV, and helps you to get more understanding of the operations for each feature.

### 1 Display [eHELP]



or



- If this is not the first time to view [eHELP] from when the TV is turned on, the confirmation screen is displayed to select whether [First Page] or [Last Page].

### 2 Select the category and item

Category field

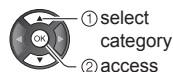

Sub item field



- To return to the previous field



- To scroll the description (if more than 1 page)

While the description is highlighted



- To display the menu related to the description (only for some descriptions)



## FAQs

Before requesting service or assistance, please follow these simple guides to solve the problem.

- For more information, refer to [eHELP] (Support > FAQs).

### The TV does not switch on

- Check the mains lead is plugged into the TV and the socket outlet.

### The TV goes into Standby mode

- Auto power standby function is activated.

### The remote control does not work or is intermittent

- Are the batteries installed correctly? ➔ (p. 9)
- Has the TV been switched on?
- The batteries may be running low. Replace them with new ones.
- Point the remote control directly at the TV's remote control signal receiver (within about 7 m and a 30 degree angle of the signal receiver).
- Situate the TV away from sunshine or other sources of bright light not to shine on the TV's remote control signal receiver.

### No image can be displayed

- Check the TV is turned on.
- Check the mains lead is plugged into the TV and the socket outlet.
- Check the correct input mode is selected.
- Check the setting of [AV] ([COMPONENT] / [VIDEO]) in [Input Selection] to match the output of the external equipment.
- Is [Contrast], [Brightness] or [Colour] in the Picture Menu set to the minimum?
- Check all required cables and connections are firmly in place.

### Unusual image is displayed

- Turn the TV off with Mains power On / Off switch, then turn it on again.
- If the problem persists, initialise all settings.  
➔ [Shipping Condition] in [System Menu] (Setup Menu)

### Parts of the TV become hot

- Even if the temperature of parts of the front, top and rear panels has risen, these temperature rises do not cause any problems in terms of performance or quality.

### The LCD panel moves slightly and clattered sound is heard when it is pushed with a finger

- There is a little gap around the panel to prevent damage to the panel. This is not a malfunction.

## Maintenance

### First, remove the mains plug from the socket outlet.

#### Display panel, Cabinet, Pedestal

##### Regular care:

Gently wipe the surface of the display panel, cabinet, or pedestal by using a soft cloth to clean the dirt or fingerprints.

##### For stubborn dirt:

- (1) First clean the dust on the surface.
- (2) Dampen a soft cloth with clean water or diluted neutral detergent (1 part detergent to 100 parts water).
- (3) Wring the cloth firmly. (Please note liquids do not enter the TV inside. May lead to product failure.)
- (4) Finally, wipe away all the moisture.

##### Caution

- Do not use a hard cloth or rub the surface too hard, otherwise this may cause scratches on the surface.
- Take care not to subject the surfaces to insect repellent, solvent, thinner or other volatile substances. This may degrade surface quality or cause peeling of the paint.
- The surface of the display panel is specially treated and may be easily damaged. Take care not to tap or scratch the surface with your fingernail or other hard objects.
- Do not allow the cabinet and pedestal to make contact with a rubber or PVC substance for a long time. This may degrade surface quality.

#### Mains plug

Wipe the mains plug with a dry cloth at regular intervals. Moisture and dust may cause fire or electrical shock.

# Specifications

## ■ TV

### Model Name

TH-32AS610G	TH-50AS610K
TH-32AS610M	TH-50AS610G
TH-42AS610K	TH-50AS610M
TH-42AS610G	
TH-42AS610M	

### Dimensions (W × H × D)

#### 32-inch model

734 mm × 502 mm × 184 mm (With Pedestal)  
734 mm × 437 mm × 69 mm (TV only)

#### 42-inch model

963 mm × 610 mm × 247 mm (With Pedestal)  
963 mm × 566 mm × 69 mm (TV only)

#### 50-inch model

1 130 mm × 702 mm × 260 mm (With Pedestal)  
1 130 mm × 658 mm × 60 mm (TV only)

### Mass

#### 32-inch model

6.0 kg Net (With Pedestal)  
5.5 kg Net (TV only)

#### 42-inch model

10.0 kg Net (With Pedestal)  
8.5 kg Net (TV only)

#### 50-inch model

15.0 kg Net (With Pedestal)  
14.0 kg Net (TV only)

### Power source

AS610G series, AS610K series:  
AC Single 220-240 V, 50 / 60 Hz

AS610M series:  
AC Auto 110-240 V, 50 / 60 Hz

### Rated power consumption

#### 32-inch model

TH-32AS610G: 60.0 W  
TH-32AS610M: 61.0 W

#### 42-inch model

TH-42AS610G: 92.0 W  
TH-42AS610K: 92.0 W  
TH-42AS610M: 93.0 W

#### 50-inch model

82.0 W

### Standby power consumption

#### 32-inch model

0.30 W

#### 42-inch model

0.20 W

#### 50-inch model

0.25 W

### Visible screen size (diagonal)

#### 32-inch model

80 cm

#### 42-inch model

106 cm

#### 50-inch model

126 cm

### Display resolution

#### 32-inch model

1 366 (W) × 768 (H)

#### 42-inch model

1 920 (W) × 1 080 (H)

#### 50-inch model

1 920 (W) × 1 080 (H)

### Panel

LED backlight Liquid Crystal Display

### Sound

#### Speaker output

20 W (10 W + 10 W)

### Connection terminals

#### AV IN (COMPONENT / VIDEO)

##### VIDEO

RCA PIN Type × 1  
1.0 V[p-p] (75 Ω)

##### AUDIO L - R

RCA PIN Type × 2  
0.5 V[rms]

##### Y

1.0 V[p-p] (including synchronisation)

##### Pb/Cb, Pr/Cr

±0.35 V[p-p]

#### HDMI 1 / 2 input

TYPE A Connectors  
HDMI1: Content Type  
HDMI2: Content Type, Audio Return Channel  
• This TV supports "HDAVI Control 5" function.

#### ETHERNET

10BASE-T / 100BASE-TX

#### USB 1 / 2

DC 5 V, Max. 500 mA [Hi-Speed USB (USB 2.0)]

#### AUDIO OUT

##### AUDIO L - R

RCA PIN Type × 2  
0.5 V[rms]

## Receiving systems / Band name

17 Systems		Function
1	PAL B, G, H	Reception of broadcast transmissions and Playback from Video Cassette Tape Recorders
2	PAL I	
3	PAL D, K	
4	SECAM B, G	
5	SECAM D, K	
6	SECAM K1	
7	NTSC M (NTSC 3.58/4.5 MHz)	
8	NTSC 4.43/5.5 MHz	Playback from Special VCR's or DVD
9	NTSC 4.43/6.0 MHz	
10	NTSC 4.43/6.5 MHz	
11	NTSC 3.58/5.5 MHz	
12	NTSC 3.58/6.0 MHz	
13	NTSC 3.58/6.5 MHz	
14	SECAM I	Playback from Special Disc Players and Special VCR's or DVD
15	PAL 60 Hz/5.5 MHz	
16	PAL 60 Hz/6.0 MHz	
17	PAL 60 Hz/6.5 MHz	

## Receiving channels (Analogue TV)

### VHF BAND

2-12 (PAL/SECAM B, K1)  
 0-12 (PAL B AUST.)  
 1-9 (PAL B N.Z.)  
 1-12 (PAL/SECAM D)  
 1-12 (NTSC M Japan)  
 2-13 (NTSC M USA)

### UHF BAND

21-69 (PAL G, H, I/SECAM G, K, K1)  
 28-69 (PAL B AUST.)  
 13-57 (PAL D, K)  
 13-62 (NTSC M Japan)  
 14-69 (NTSC M USA)

### CATV

S1-S20 (OSCAR)  
 1-125 (USA CATV)  
 C13-C49 (JAPAN)  
 S21-S41 (HYPER)  
 Z1-Z37 (CHINA)  
 5A, 9A (AUST.)

## Aerial input

VHF / UHF

## Operating conditions

### Temperature

0 °C - 40 °C

## Built-in wireless LAN

### Standard compliance and Frequency range\*

IEEE802.11a/n  
 5.15 GHz -5.35 GHz, 5.47 GHz -5.85 GHz  
 IEEE802.11b/g/n  
 2.40 GHz -2.4835 GHz

### Security

WPA2-PSK (TKIP/AES)  
 WPA-PSK (TKIP/AES)  
 WEP (64 bit/128 bit)

\* The frequency and channel differ depending on the country.

### Note

- Design and Specifications are subject to change without notice. Mass and Dimensions shown are approximate.
- For the information of the open source software, refer to [eHELP] (Support > Licence).

### ■ When using the wall-hanging bracket

- Please contact your local Panasonic dealer to purchase the recommended wall-hanging bracket.
- Holes for wall-hanging bracket installation.

Rear of the TV

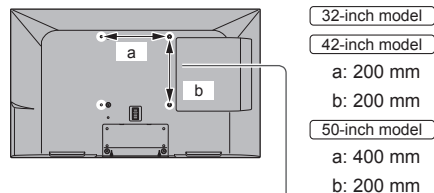

(View from the side)

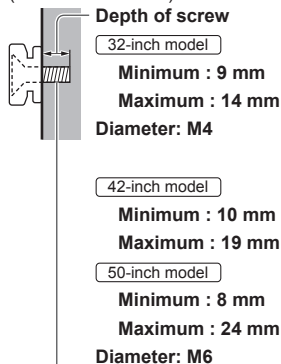

Screw for fixing the TV onto the wall-hanging bracket (not supplied with the TV)

UAE

Built-in WLAN

**UAE-TRA**  
REGISTERED No.  
ER0120168/13  
DEALER No.  
DA0052708/10

Nigeria

Connection and use of this communications  
equipment is permitted by the Nigerian  
Communications Commission

### Information on Disposal in other Countries outside the European Union



This symbol is only valid in the European Union. If you wish to discard this product, please contact your local authorities or dealer and ask for the correct method of disposal.

### Customer's Record

The model number and serial number of this product may be found on its rear panel. You should note this serial number in the space provided below and retain this book, plus your purchase receipt, as a permanent record of your purchase to aid in identification in the event of theft or loss, and for Warranty Service purposes.

**Model Number**

**Serial Number**

**Panasonic Corporation**

Web Site: <http://panasonic.net>

English