

Panasonic®

Operating Instructions CD Stereo System

Model No. **SC-MAX370**

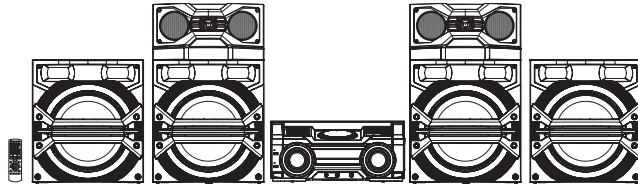

Thank you for purchasing this product.
Please read these instructions carefully before using this product, and save this manual for future use.

Table of contents

Safety precautions	2
Reference	3
Supplied accessories	3
Placement of speakers	4
Maintenance	4
Preparing the remote control	4
Making the connections	5
Overview of controls	6
Disc	7
USB and internal memory	8
Radio	11
Bluetooth®	12
Clock and timers	14
Sound and illumination	14
DJ functions	15
Using a microphone	16
Using the auxiliary input	16
Customer Service	17
Troubleshooting	17
System memory reset (initialization)	18
Remote control code	18
Specifications	19



CAUTION!

Unit

- To reduce the risk of fire, electric shock or product damage,
 - Do not install or place this unit in a bookcase, built-in cabinet or in another confined space. Ensure this unit is well ventilated.
 - Do not obstruct this unit's ventilation openings with newspapers, tablecloths, curtains, and similar items.
 - Do not place sources of naked flames, such as lighted candles, on this unit.
- Set this unit up on an even surface away from direct sunlight, high temperatures, high humidity, and excessive vibration.
- This unit is intended for use in moderate climates.
- The mains plug is the disconnecting device. Install this unit so that the mains plug can be unplugged from the socket outlet immediately.
- This unit may receive radio interference caused by mobile telephones during use. If such interference occurs, please increase separation between this unit and the mobile telephone.
- This unit utilizes a laser. Use of controls or adjustments or performance of procedures other than those specified herein may result in hazardous radiation exposure.

Battery

- Danger of explosion if battery is incorrectly replaced. Replace only with the type recommended by the manufacturer.
- When disposing of the batteries, please contact your local authorities or dealer and ask for the correct method of disposal.
- Do not heat or expose to flame.
- Do not leave the battery(ies) in a car exposed to direct sunlight for a long period of time with doors and windows closed.
- Do not break open or short-circuit the battery.
- Do not charge the alkaline or manganese battery.
- Do not use the battery if the cover has peeled off.
- Remove the battery if you do not use the remote control for a long period of time. Keep in a cool, dark area.

Do the procedures with the remote control. You can also use the buttons on the main unit if they are the same.

Your system and the illustrations can look differently.

These operating instructions are applicable to the following system.

System	SC-MAX370
Main unit	SA-MAX370
Front Speakers	SB-MAF370
Subwoofers	SB-MAW370 SB-MAY370

About descriptions in these Operating Instructions

- Titles to be referred to are indicated as "⇒ ○○".
- Unless otherwise indicated, operations are described using the remote control.

Safety precautions

WARNING!

Unit

- To reduce the risk of fire, electric shock or product damage,
 - Do not expose this unit to rain, moisture, dripping or splashing.
 - Do not place objects filled with liquids, such as vases, on this unit.
 - Use only the recommended accessories.
 - Do not remove covers.
 - Do not repair this unit by yourself. Refer servicing to qualified service personnel.
- Do not let metal objects fall inside this unit.

CAUTION!

- Use the speakers only with the recommended system. If not, you can cause damage to the amplifier and speakers and can cause a fire.
- Consult an approved service personnel if damage occurs or if there is a sudden apparent change in performance.
- Do the procedures included in these instructions when you attach the speakers.
- Be careful when babies or children are near.

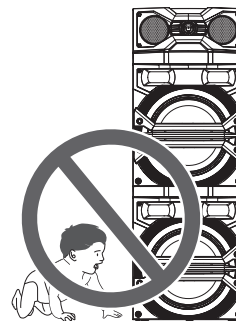

Reference

Operation is subject to the following two conditions:

- (1) This device may not cause harmful interference, and (2) this device must accept any interference received, including interference that may cause undesired operation.

Software update

Occasionally, Panasonic may release updated software for this unit that may add or improve the way a feature operates. These updates are available free of charge. For more details, refer to the following website.

<http://panasonic.jp/support/global/cs/>

(This site is in English only.)

About Bluetooth®

Panasonic bears no responsibility for data and/or information that can possibly be compromised during a wireless transmission.

Frequency band

- This system uses the 2.4 GHz frequency band.

Certification

- This system conforms to the frequency restrictions and has received certification based on frequency laws. Thus, a wireless permit is not necessary.
- The actions below are punishable by law:
 - Taking apart or modifying the main unit.
 - Removing specification indications.

Restrictions of use

- Wireless transmission and/or usage with all Bluetooth® equipped devices is not guaranteed.
- All devices must conform to standards set by Bluetooth SIG, Inc.
- Depending on the specifications and settings of a device, it can fail to connect or some operations can be different.
- This system supports Bluetooth® security features. But depending on the operating environment and/or settings, this security is possibly not sufficient. Transmit data wirelessly to this system with caution.
- This system cannot transmit data to a Bluetooth® device.

Range of use

- Use this device at a maximum range of 10 m.
- The range can decrease depending on the environment, obstacles or interference.

Interference from other devices

- This system may not function properly and troubles such as noise and sound jumps may arise due to radio wave interference if this unit is located too close to other Bluetooth® devices or the devices that use the 2.4 GHz band.
- This system may not function properly if radio waves from a nearby broadcasting station, etc. is too strong.

Intended usage

- This system is for normal, general use only.
- Do not use this system near an equipment or in an environment that is sensitive to radio frequency interference (example: airports, hospitals, laboratories, etc.).

Licenses

MPEG Layer-3 audio coding technology licensed from Fraunhofer IIS and Thomson.

The Bluetooth® word mark and logos are owned by the Bluetooth SIG, Inc. and any use of such marks by Panasonic Corporation is under license. Other trademarks and trade names are those of their respective owners.

Google Play and Android are trademarks of Google Inc.

To dispose or transfer this system

This system may keep the user settings information internally. If you discard this system either by disposal or transfer, then follow the procedure to return all the settings to the factory presets to delete the user settings.

- To delete all recorded tracks in the internal memory (refer to page 11).
- To return all sample sounds to the factory preset (refer to page 15).
- To reset system memory (refer to page 18).

Note:

- The operation history may be recorded in the memory of this system.

Supplied accessories

Check and identify the supplied accessories.

- 1 x AC power supply cord
- 1 x AM loop antenna
- 1 x FM indoor antenna



- 1 x Remote control battery
- 1 x Remote control (N2QAYB000915)
- 4 x stacking bracket (In speakers packaging)
- 1 x Power plug adapter

Placement of speakers

- 1 Subwoofer SB-MAW370 (L)
- 2 Subwoofer SB-MAW370 (R)
- 3 Subwoofer SB-MAY370 (L)
- 4 Subwoofer SB-MAY370 (R)
- 5 Front speaker SB-MAF370 (L)
- 6 Front speaker SB-MAF370 (R)
- 7 Stacking bracket

Setup 1

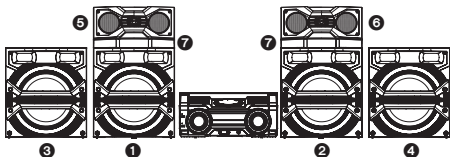

Setup 2

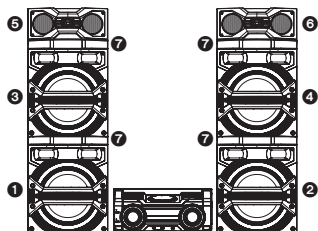

Subwoofers

Put on the floor or a sturdy shelf to reduce vibration.

CAUTION!

Do not touch the subwoofer cones reverberating surfaces:

- This may damage the subwoofer cone.
- The subwoofer cone may be hot.

Use only the supplied speakers.

You can cause damage to the system and decrease the sound quality if you use other speakers.

Note:

- Keep your speakers more than 10 mm from the main unit for ventilation.
- Put the speakers on a flat safe surface.
- These speakers do not have magnetic shielding. Do not put them near TVs, PCs or other equipment easily influenced by magnetism.
- When you play at high levels for a long period, it can cause damage to the speakers and decrease the life of the speakers.
- Decrease the volume in these conditions to prevent damage:
 - When the sound is distorted.
 - When you adjust the sound quality.

Maintenance

To clean this system, wipe with a soft, dry cloth.

- Never use alcohol, paint thinner or benzine to clean this system.
- Before using chemically treated cloth, read the instructions that came with the cloth carefully.

Preparing the remote control

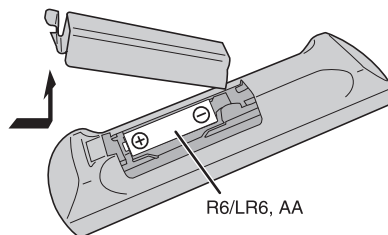

Use alkaline or manganese battery.

Install the battery so that the poles (+ and -) align with those in the remote control.

Stacking the speakers

1 Put the stacking bracket on top of the subwoofer SB-MAW370/SB-MAY370.

Press down the stacking bracket until it is secured in position.

e.g

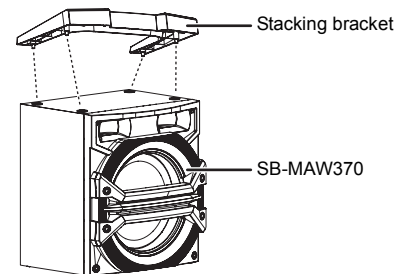

2 Stack the speakers according to Setup 1 or Setup 2. (⇒ "Placement of speakers").

Example: Stacking of front speaker in Setup 1 arrangement.

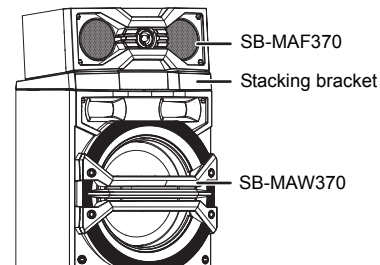

Making the connections

Connect the AC power supply cord only after all the other connections have been made.

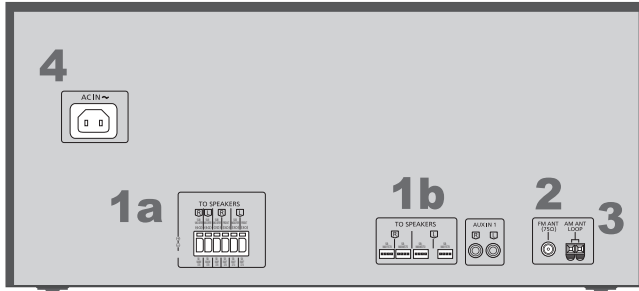

1 Connect the speakers.

Connect the speaker cables to the terminals of the same color.

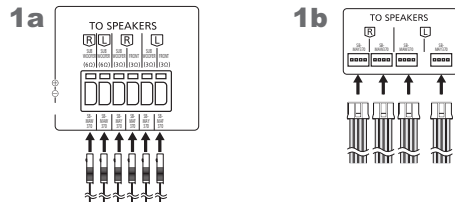

2 Connect the FM indoor antenna.

Put the antenna where reception is best.

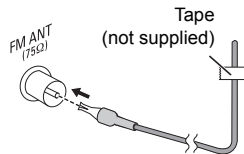

3 Connect the AM loop antenna.

Stand the antenna up on its base until it clicks.

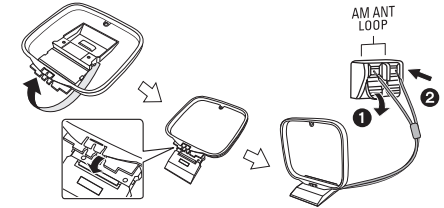

4 Connect the AC power supply cord.

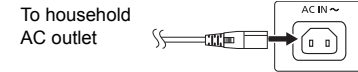

If the power plug does not fit your socket, use the supplied power plug adapter.

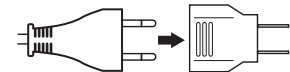

Do not use any other AC power supply cord except the supplied one.

Conserving power

The system consumes approximately 0.3 W when it is in standby mode. Disconnect the power supply if you do not use the system.

Some settings will be lost after you disconnect the system. You have to set them again.

Overview of controls

Remote control

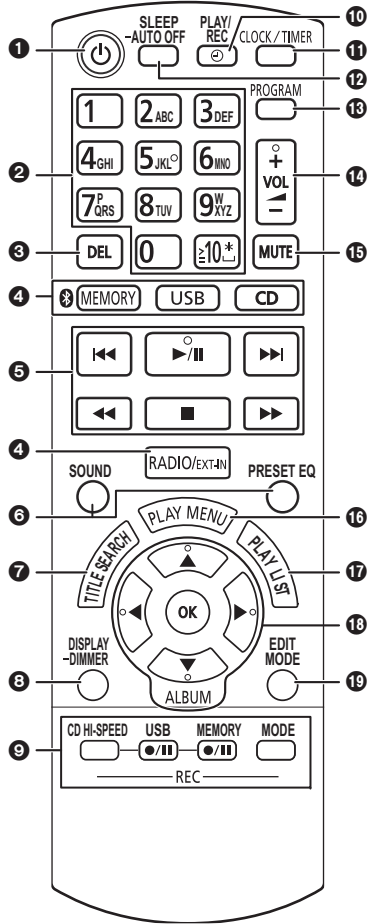

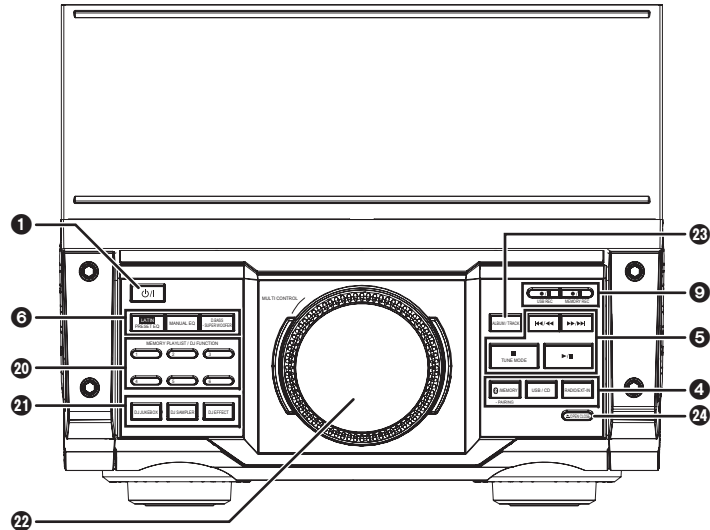

Top view

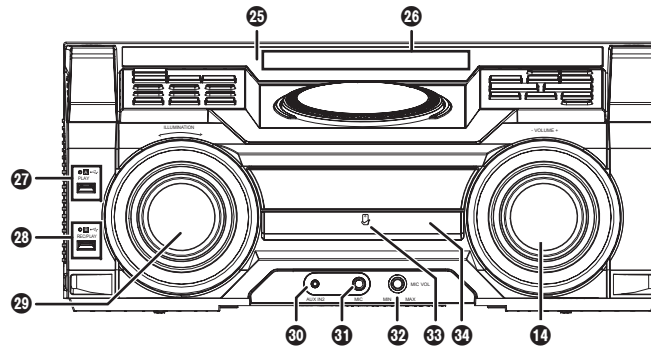

Front view



- 1 Standby/on switch** [⏻], [⏻/⏪]
Press to switch the unit from on to standby mode or vice versa. In standby mode, the unit is still consuming a small amount of power.
- 2** Alphanumeric buttons
To select a 2-digit number
Example: 16: [≧10]→[1]→[0]
To set a character
Example: B: [2]→[2]
- 3** Delete a programmed track
Delete a selected track in a playlist
- 4** Select audio source
- 5** Basic playback control
- 6** Select the sound effects
- 7** Start the title search for internal memory
- 8** View content information
Press and hold the button: Decrease the brightness of the display panel and turn off the DJ function buttons and illumination, etc.
- 9** Recording operation control
- 10** Set the play timer or record timer
- 11** Set the clock and timer
- 12** Set the sleep timer
Press and hold the button: Automatically switch off function switches off the system if you do not use the system for 20 minutes. (Except radio)
- 13** Set the program function
- 14** Adjust the volume of the system
- 15 Mute the sound of the system**
To cancel, press the button again.
"MUTE" is also canceled when you adjust the volume or when you switch off the system.
- 16** Set the play menu item
- 17** Internal memory playlist operation
- 18** Select and enter buttons
- 19** Set the edit mode for **USB B** and internal memory
- 20** Internal memory playlist direct buttons
Press and hold to add a track to the corresponding playlist. Press to select the playlist.
DJ function direct buttons
Press [DJ JUKEBOX], [DJ SAMPLER] or [DJ EFFECT] to switch on the DJ function.
Press [1] to [6] on main unit to select the desired function.
To cancel, press the selected [1] to [6] again.
- 21 Switch on the DJ function**
To cancel, press the button again.
- 22** Turntable for DJ and multi control
- 23** Browse playlist of the internal memory
Browse tracks or albums
CD
Turn [MULTI CONTROL] to browse the track.
Press [▶/||] to start playback from the selection.
MP3
Press [ALBUM/TRACK] to select album or track and then turn [MULTI CONTROL] to browse.
Press [▶/||] to start playback from the selection.
- 24** Open or close the disc tray
- 25** Remote control sensor
Distance: Within approximately 7 m
Angle: Approximately 20° up and down, 30° left and right
- 26** Display panel
- 27** **USB A** PLAY
USB port (↔) 
USB status indicator
- 28** **USB B** REC/PLAY
USB port (↔) 
USB status indicator
- 29** Select the illumination effect
- 30** AUX IN 2 terminal
- 31** Microphone jack
- 32** Adjust the volume of the microphone
- 33** NFC touch area
- 34** Disc tray

Disc

Playing disc

- 1** Press [▲ OPEN/CLOSE] on the main unit to open the disc tray.
Put in a disc with the label facing up.
Press [▲ OPEN/CLOSE] again to close the disc tray.
- 2** Press [CD] and then press [▶/||] to start playback.
- **Stop playback**
Press [■].
 - **Pause playback**
Press [▶/||].
Press again to continue playback.
 - **Skip album** (MP3)
Press [▲, ▼].
 - **Skip track**
Press [◀◀] or [▶▶]
(main unit: [◀◀/◀◀] or [▶▶/▶▶]).
 - **Search through track**
Press and hold [◀◀] or [▶▶]
(main unit: [◀◀/◀◀] or [▶▶/▶▶]).

Viewing available information

You can view the available information on the display panel.

Press [DISPLAY-DIMMER] during playback.

Note:

- Maximum characters that can be shown: approximately 32
- This system supports ver. 1.0, ver. 1.1 and ver. 2 ID3 tags.
- Text data that the system does not support can show differently.

Play menu

- 1 Press [PLAY MENU] to select "PLAYMODE" or "REPEAT".
- 2 Press [◀, ▶] and then press [OK] to select the desired mode.

PLAYMODE

• OFF PLAYMODE

Play all tracks.

• 1-TRACK

Play one selected track on the disc.

Press the alphanumeric buttons to select the track.

• 1-ALBUM (MP3)

Play one selected album on the disc.

Press [▲, ▼] to select the album.

• RANDOM

Play a disc randomly.

• 1-ALBUM RANDOM (MP3)

Play all tracks in one selected album randomly.

Press [▲, ▼] to select the album.

REPEAT

• ON REPEAT

Repeat playback.

"↺" appears.

• OFF REPEAT

Cancel repeat playback.

Note:

The setting returns to the default "OFF PLAYMODE" when you open the disc tray.

Program playback

This function allows you to program up to 24 tracks.

- 1 Press [PROGRAM] in the stop mode.
"PGM" or "PROGRAM" is shown.
- 2 (CD)
Press the alphanumeric buttons to select the desired track.
Do this step again to program other tracks.
(MP3)
1 Press [▲, ▼] to select the desired album.
2 Press [▶▶] and then press the alphanumeric buttons to select the desired track.
3 Press [OK].
Do these steps again to program other tracks.
- 3 Press [▶/||] to start playback.
 - **Cancel program mode**
Press [PROGRAM] in the stop mode.
 - **Check program contents**
Press [◀◀] or [▶▶] when "PGM" is shown in the stop mode.
 - **Clear the last track**
Press [DEL] in the stop mode.
 - **Clear all programmed tracks**
Press [■] in the stop mode.
"CLR ALL" is shown.
Within 5 seconds, press [■] again.

Note:

- You cannot use program playback together with "PLAYMODE" function.
- The program memory is cleared when you open the disc tray.

Note on disc

- This system can play CD-R/RW with CD-DA or MP3 format content.
- Some CD-R/RW cannot be played because of the condition of the recording.
- MP3 files are defined as tracks and folders are defined as albums.
- This system can access up to:
 - CD-DA: 99 tracks
 - MP3: 999 tracks, 255 albums
- Disc must conform to ISO9660 level 1 or 2 (except for extended formats).
- Recordings will not necessarily be played in the order you recorded them.

USB and internal memory

You can connect and play music tracks from your USB device.

You can also record sound or music tracks into the internal memory in ".mp3" format.

This system can play or record up to 800 folders (maximum 999 tracks in an album) or a total of 8000 tracks, depending on the available storage capacity.

Connecting a USB device

Preparation

Before you connect a USB device to the system, make sure you do a backup of the data.

Do not use a USB extension cable. The system cannot recognize USB device connected through a cable.

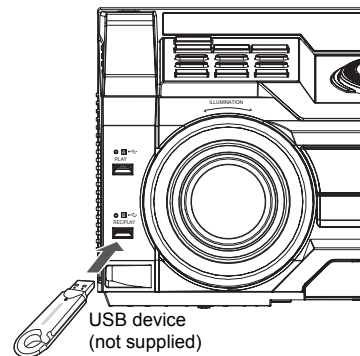

Decrease the volume and connect the USB device to the USB port.

Hold the main unit when connecting or disconnecting the USB device.

USB at a glance

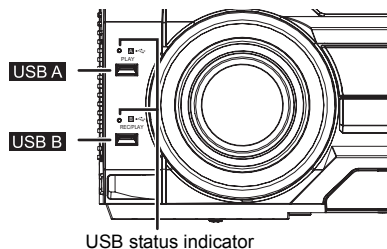

- **USB A**
 - Play MP3 tracks.
- **USB B**
 - Record/play MP3 tracks.

Note:

USB status indicator blinks during USB recording.

Note:

USB status indicator lights up when selected.

Recording to a USB device or the internal memory

Panasonic cannot be held responsible on the action of consumer to record copyrighted contents which can cause copyright infringement.

Note:

- All recordings are in ".mp3" format.
- You cannot do recording when you are using random playback mode.
- Repeat playback mode is off during recording.
- A new album is added each time you do a recording.
- The sequence of album can change after the recording.
- The recordings are kept in a folder named "REC_DATA" in the USB device or the internal memory.
- The recorded tracks will be sorted in the following order automatically.
 - Recorded tracks from Audio CD, radio or external input (Sorted by recorded)
 - Recorded mp3 tracks from CD or USB device (Sorted by alphabet)

Basic recording

1 Select the source you want to record.

CD

Prepare the disc playback mode.

Record all tracks

Select "OFF PLAYMODE" (⇒ "Play menu").

Record programmed tracks

Program the tracks you want (⇒ "Program playback").

Record a single track

Select "1-TRACK" (⇒ "Play menu").

Make sure the disc is stopped.

Radio

Tune in to the radio station.

External equipment

Connect and play the equipment (⇒ "Using the auxiliary input").

2 Press [MEMORY REC ●/||] or [USB REC ●/||] to start recording.

The name of the folder that keeps the recording is shown.

Stop recording

Press [■]. "WRITING" is shown.

Pause recording

Press [MEMORY REC ●/||] or [USB REC ●/||] during recording.

Press again to continue recording.

Note:

You can pause during recording from the radio or AUX (except in SYNCHRO mode). A track mark is added every time you pause (⇒ "Adding track marks").

Note:

- Wait for a few seconds for the system to prepare the USB device before you start recording.
- USB status indicator blinks during USB recording.

Recording MP3 tracks

MP3

You can record MP3 tracks from:

- MP3 disc to **USB B** or internal memory
- **USB A** to **USB B** or internal memory
- **USB B** to internal memory, or vice versa

1 Prepare the source you want to record.

Record all tracks

Select "OFF PLAYMODE" (⇒ "Play menu").

Record programmed tracks

Program the tracks you want (⇒ "Program playback").

Record specified album or track

Select "1-ALBUM" or "1-TRACK" (⇒ "Play menu").

2 Press [MEMORY REC ●/||] or [USB REC ●/||] to start recording.

Example: Recording an album from the USB device to the internal memory.

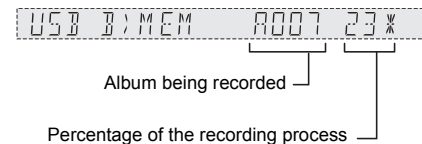

Stop recording

Press [■].

Recording stops at the last fully recorded track in the album.

For example, if you stop recording during the fourth track, only the first three tracks are recorded. "NO FILE RECORDED" is shown if no track is recorded.

Note:

- Some tracks can use a longer time to record.
- Some tracks cannot be recorded because of the condition of the source.
- The recorded folder name may be different from the original folder because of the auto rename function.

Basic playback

MEMORY

1 Press [**M**], MEMORY (main unit: [**M**]/MEMORY) to select "MEMORY".

2 Press [**▶/||**] to start playback.

USB A USB B

1 Press [USB] to select "USB B" or "USB A".

2 Press [**▶/||**] to start playback.

• Stop playback

Press [**■**]. "RESUME" is shown.

Press [**▶/||**] to continue playback.

OR

Press [**■**] two times to stop the playback fully.

For other operations, refer to "Disc".

Viewing available information

You can view the available information on the display panel.

Press [DISPLAY-DIMMER].

• In the stop mode

Available storage space or remaining recording time of the internal memory or the USB device in **USB B**.

• During recording

Information that is related to recording.

• During playback or pause

Information of the current track.

Title search

MEMORY

You can search for the desired track in the internal memory with title search.

1 Press [TITLE SEARCH].

"**⏪**" blinks.

2 Press the alphanumeric buttons or [**▲**], [**▼**] to select the desired character then press [**▶**] to select next character.

To delete a character, press [DEL].



3 Press [OK].

Press [**◀**], [**▶**] to search for previous or next match.

"NOT FOUND" is shown if there is no match.

4 Press [OK] to confirm and play the track.

To cancel, press [TITLE SEARCH].

Note:

- This function skip tracks that are created with basic recording (⇒ "Basic recording").
- This function does not work with random or program playback.
- The character is not case sensitive.
- A same track title display will be shown for tracks with the same title.

Playlist

MEMORY

You can keep up to 6 playlists in the internal memory. Each playlist can keep up to 99 tracks.

Adding tracks to the playlist

1 Select the track you want to add to the playlist.

2 Press [PLAY LIST].

3 Press and hold the alphanumeric button (1 to 6) to add the track to the corresponding playlist.

Or press and hold [1] to [6] on the main unit to add the track to the corresponding playlist.

Do steps 1 through 3 again to add more tracks.

Listening to the playlist

1 Press [PLAY LIST] and then the alphanumeric button (1 to 6) to select the playlist.

Or press [1] to [6] on the main unit to select the playlist.

2 Press [**▶/||**] to start playback.

• Cancel playlist playback

Press [PLAY LIST] two times.

OR

Press the selected [1] to [6] on the main unit.

• View contents of the playlist

Press [**◀◀**] or [**▶▶**] in the stop mode.

OR

Turn [MULTI CONTROL] in the stop mode.

• Clear a single track

In the stop mode, press [**◀◀**] or [**▶▶**] to select the desired track you want to clear and then press [DEL].

"DELETE?" is shown.

Within 5 seconds, press [OK].

• Clear all tracks in a playlist

In the stop mode, press [**■**].

"CLEAR?" is shown.

Within 5 seconds, press [OK].

Advanced recording functions

High-speed recording



Recording speed:

CD, CD-R: Up to three times (3x) of the normal speed.

CD-RW: Up to two times (2x) of the normal speed.

- 1 Put in the disc you want to record.
- 2 Press [CD].
- 3 Press [CD HI-SPEED REC] and [USB REC ●/||] or [MEMORY REC ●/||] together to start recording.

Note:

- If you cannot record at high-speed because of the condition of the disc, record the CD at normal speed.
- The sound is muted during high-speed recording.

Adding track marks

When recording from radio or external equipment, you can divide tracks using various modes.

Before recording

Press [REC MODE] to select the desired setting.

- **MANUAL**
Add a track mark manually.
Press [OK] during recording to add a track mark.
- **TIME MARK**
A track is automatically divided at 5-minute intervals.
- **SYNCHRO**
(For AUX source)
Recording starts automatically when the other equipment starts to play.
Recording pause when it detects silence for 3 seconds.

Note:

- During recording, if you press [OK] or pause recording while using TIME MARK mode, the 5-minute counter is reset.
- You cannot add track marks manually in SYNCHRO mode.

Deleting the recorded tracks

1 MEMORY

Press [Ⓜ], MEMORY] (main unit: [Ⓜ]/MEMORY]) to select "MEMORY".

USB B

Press [USB] (main unit: [USB/CD]) to select "USB B".

- 2 Press [▲, ▼] to select the desired album.
- 3 Press [◀◀] or [▶▶] to select the desired track.
- 4 Press [EDIT MODE] to select the desired mode.
 - **TRACK DEL**
Delete a single track.
 - **ALBUM DEL**
Delete one album (maximum 999 tracks).
 - **FORMAT**
Format the USB device.
 - **ALL DEL**
Delete all albums in the internal memory.
- 5 Press [OK].
The selected item to be deleted is shown.
- 6 Press [OK].
"SURE? NO" is shown.
- 7 Press [◀, ▶] to select "YES" or "NO" and then press [OK].
Select "YES" to confirm the deletion.
"WRITING" is shown.

Note on USB

Compatible USB devices which are defined as mass storage class:

- USB devices that support bulk-only transfer.
- USB devices that support USB 2.0 full speed.

Note:

- Folders are defined as album.
- Files are defined as track.
- Track must have the extension ".mp3" or ".MP3".
- CBI (Control/Bulk/Interrupt) is not supported.
- NTFS file system is not supported (only FAT 12/16/32 file system is supported).
- Some files can fail to work because of the sector size.

Radio

Manual tuning

- 1 Press [RADIO/EXT-IN] to select "FM" or "AM".
- 2 Press [◀◀] or [▶▶] to select the frequency of the required station.
To tune automatically, press and hold the button until the frequency starts changing quickly.
"STEREO" is shown when a stereo broadcast is being received.

Using the main unit

- 1 Press [RADIO/EXT-IN] to select "FM" or "AM".
- 2 Press [TUNE MODE] to select "MANUAL".
- 3 Press [◀◀/◀] or [▶/▶▶] to select the frequency of the required station.

Improving the sound quality

When "FM" is selected

- 1 Press [PLAY MENU] to select "FM MODE".
- 2 Press [◀, ▶] to select "MONO" and then press [OK].
To cancel, select "STEREO".
"MONO" is also canceled when you change the frequency.

When "AM" is selected

- 1 Press [PLAY MENU] to select "BEATPROOF".
- 2 Press [◀, ▶] to select from "BP 1" to "BP 4" that provides the best reception and then press [OK].

Memory presetting

30 FM and 15 AM stations can be preset.

Automatic presetting

- 1 Press [OK] to select “LOWEST” or “CURRENT” frequency.
- 2 Press [PLAY MENU] to select “A.PRESET” and then press [OK]. “START?” is shown.
- 3 Press [OK] to start presetting. To cancel, press [■].

Manual presetting

- 1 Press [◀◀] or [▶▶] to tune in to the station.
- 2 Press [PROGRAM].
- 3 Press the alphanumeric buttons to select a preset number. Do steps 1 through 3 again to preset more stations. The new station replaces any station that occupies the same preset number.

Selecting a preset station

Press the alphanumeric buttons, [◀◀] or [▶▶] to select the preset station.

Using the main unit

- 1 Press [TUNE MODE] to select “PRESET”.
- 2 Press [◀◀/◀◀] or [▶▶/▶▶] to select the preset station.

AM allocation setting

By main unit only

This system can also receive AM broadcasts allocated in 10 kHz steps.

- 1 Press [RADIO/EXT-IN] to select “FM” or “AM”.
- 2 Press and hold [RADIO/EXT-IN].

After a few seconds, the display panel shows the current minimum radio frequency. Release the button when the minimum frequency changes.

- To go back to the initial setting, do the above steps again.
- After you change the setting, preset frequencies are erased.

Bluetooth®

You can connect and play an audio device wirelessly through Bluetooth®.

- Refer to the operating instructions of the Bluetooth® device for details.
- If you intend to use an NFC (Near Field Communication)-compatible Bluetooth® device, proceed to “One-Touch Connection (Connecting by NFC)”.
- Decrease the volume before connect the Bluetooth® device.

Pairing a device

Preparation

- Turn on the Bluetooth® feature of the device and place the device near this unit.

- 1 Press and hold [Ⓜ/MEMORY,-PAIRING] on main unit.



- 2 Select “SC-MAX370” from the Bluetooth® menu of the device.

The device connects with this system automatically after pairing is complete.

- 3 Start playback on the Bluetooth® device.

For other operations on main unit, refer to “Playing disc”.

Note:

- You can also operate with the remote control.
 - 1 Press [Ⓜ, MEMORY] to select “BLUETOOTH”.
 - 2 Press [PLAY MENU] to select “PAIRING”.
 - 3 Press [◀, ▶] to select “OK? YES” and then press [OK].
 - 4 Select “SC-MAX370” from the Bluetooth® menu of the device.
- If prompted for a passkey, input “0000”.
- A device must be paired to connect.
- You can register up to 8 devices with this unit. If a 9th device is paired, the device that has not been used for the longest time will be replaced.
- This system can only connect to one device at a time.
- When “BLUETOOTH” is selected as the source, this system will automatically try and connect to the last connected device.

One-Touch Connection (Connecting by NFC)

For NFC-compatible Android™ devices only

Simply by touching an NFC (Near Field Communication)-compatible Bluetooth® device by the unit, you can complete all preparations, from registering a Bluetooth® device to establishing a connection.

Preparation

- Turn on the NFC feature of the device.
- Android device version lower than 4.1 requires the installation of the app “Panasonic MAX Juke” (Free of charge).
 - 1 Enter “Panasonic MAX Juke” in the search box of Google Play™ to search, and then select “Panasonic MAX Juke”.
 - 2 Start the app “Panasonic MAX Juke” on the device.
 - Follow on-screen instructions on your device.
 - Always use the latest version of the app.

- 1 Press [**Ⓜ**, MEMORY] (main unit: [**Ⓜ**/MEMORY,-PAIRING]) to select “BLUETOOTH”.
- 2 Touch and hold your device on the NFC touch area of this unit [**Ⓜ**].

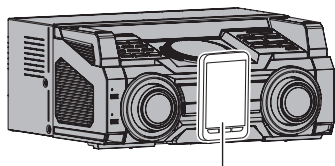

Bluetooth® device

- Once the registration and connection of the Bluetooth® device is complete, the name of the connected device is indicated on the display. Move the device away from the unit.
 - When the connection is not established even if your device has touched the NFC touch area, change its touching position.
- 3 Start playback on the Bluetooth® device.

Note:

- If you touch another device to this unit, you can update the Bluetooth® connection. The previously connected device will be disconnected automatically.
- If the image and sound are out of sync during playback, restart the playback app you are using. If the problem persists, connect the Bluetooth® device and this unit with an audio cable (not supplied).
- When the connection is established, the playback may start automatically depending on the type of device being used.
- The One-Touch Connection may not work properly depending on the type of device being used.

Bluetooth® standby mode

If you enable this function, even when the main unit is turned off, it will turn on automatically when a Bluetooth® device sends a connection request.

- 1 Press [**Ⓜ**, MEMORY] (main unit: [**Ⓜ**/MEMORY,-PAIRING]) to select “BLUETOOTH”.
- 2 Press [PLAY MENU] to select “STANDBY MODE”.
- 3 Press [**◀**, ▶] to select “ON STANDBY MODE” or “OFF STANDBY MODE” and then press [OK].

Viewing available information

You can view the following information on the display panel:

- Name of the connected device (maximum 16 characters).
- Bluetooth® profile used.

Press [DISPLAY-DIMMER].

Link mode

You can change the transmission speed to prioritize transmission quality or sound quality.

Preparation

If this system is connected to a Bluetooth® device, disconnect it (⇒ “Disconnecting a device”).

- 1 Press [PLAY MENU] to select “LINK MODE”.
- 2 Press [**◀**, ▶] to select “MODE 1” or “MODE 2” and then press [OK].
 - MODE 1
Emphasis on connectivity.
 - MODE 2
Emphasis on sound quality.

Note:

The default setting is “MODE 2”.

Disconnecting a device

- 1 Press [PLAY MENU] repeatedly to select “DISCONNECT?”.
- 2 Press [**◀**, ▶] to select “OK? YES” and then press [OK].

Note:

A device is disconnected when you:

- Select a different source.
- Move the device out of the maximum range.
- Disable the Bluetooth® transmission of the device.
- Switch off the system or the device.

Clock and timers

Setting the clock

This is a 24-hour clock.

- 1 Press [CLOCK/TIMER] to select “CLOCK”.
- 2 Within 20 seconds, press [▲, ▼] to set the time.
- 3 Press [OK].

Press [CLOCK/TIMER] to show the clock for a few seconds.

Note:

- Reset the clock regularly to maintain accuracy.
- The clock is reset when there is a power failure or when the AC power supply cord is removed.

Play and record timer

Except for Bluetooth® source

You can set the timer to come on at a certain time to:

- Wake you up (play timer)
- Record from the radio or the external equipment (record timer)

Play timer and record timer cannot be used together.

Preparation

Set the clock.

- 1 Press [CLOCK/TIMER] to select “⌚ PLAY” or “⌚ REC”.
- 2 Within 10 seconds, press [▲, ▼] to set the start time.
- 3 Press [OK].
- 4 Do steps 2 and 3 again to set the end time.
- 5 Press [▲, ▼] to select the source you want to play or record and then press [OK].

6 For record timer

Press [▲, ▼] to select “MEMORY” or “USB B” to keep the recording and then press [OK].

To start the timer

1 Prepare the audio source.

• Play timer

Prepare the music source you want to listen to (disc, USB, internal memory, radio or external equipment) and set the volume.

• Record timer

Connect the USB device to **USB B** (for USB recording) and tune to the radio station or select the external equipment.

2 Press [PLAY/REC ⏪] to select “⌚ PLAY ON” or “⌚ REC ON”.

“⌚ PLAY ON” or “⌚ REC ON” is shown.

To cancel, press [PLAY/REC ⏪] to select “TIMER OFF”.

The system must be switched off for the timer to operate.

To check the settings

Press [CLOCK/TIMER] to select “⌚ PLAY” or “⌚ REC”.

Note:

- The play timer starts at a low volume and increases gradually to the preset level.
- The record timer starts 30 seconds before the set time with the volume muted.
- The timer comes on at the set time every day if the timer is on.

Sleep timer

The sleep timer switches off the system after the set time.

Press [SLEEP-AUTO OFF] to select the setting (in minutes).

To cancel, select “OFF”.

30 MIN → 60 MIN → 90 MIN → 120 MIN → OFF

Note:

- The play and sleep timer or the record and sleep timer can be used together.
- The sleep timer always comes first. Be sure not to set an overlap of timers.

Sound and illumination

Adjust the sound effect

You can adjust the sound effect.

- 1 Press [SOUND] to select the sound effect.
- 2 Press [◀, ▶] to select the desired setting.

• BASS/MID/TREBLE

-4 to +4

• SURROUND

“ON SURROUND” or “OFF SURROUND”

• INPUT LEVEL

(For AUX IN 2)

“NORMAL” or “HIGH”

Note:

Select “NORMAL” if the sound is distorted during “HIGH” input level.

• SUPER WOOFER

“SW1”, “SW2”, “SW3” or “OFF”

• D.BASS

“D.BASS ON”, “D.BASS BEAT” or “D.BASS OFF”

Note:

D.BASS BEAT: This function emphasizes the attack level of the drum beat and produces a punchy sound.

- Depending on the type of a track, the effect may be small.

Preset EQ

Press [PRESET EQ] (main unit: [LATIN PRESET EQ]) to select desired preset.

Using the main unit

You can adjust certain sound effect using the controls on the main unit.

1 Press the button to select the sound effect.

• PRESET EQ

Press [PRESET EQ] (main unit: [LATIN] PRESET EQ)

• BASS/MID/TREBLE

Press [MANUAL EQ]

• D.BASS

Press [D.BASS,-SUPER WOOFER]

• SUPER WOOFER

Press and hold [D.BASS,-SUPER WOOFER]

2 Turn [MULTI CONTROL] to select the desired setting.

Illumination effects

By main unit only

You can change the illumination pattern or color on this system.

Turn [ILLUMINATION] to select pattern or color.

• PATTERN

Illuminate with pattern in multiple colors.

• COLOR

Illuminate in one color.

• OFF

Note:

To ensure the illumination effects are shown properly, make sure to arrange the speakers accordingly as in "Placement of speakers".

DJ functions

DJ functions has the following functions

- DJ jukebox
- DJ sampler
- DJ effects

Using these functions, you can add various effects to the track you are playing back.

If you use the app "Panasonic MAX Juke"

By installing the app "Panasonic MAX Juke" (free of charge) on your Android device, you can use a wider variety of functions.

Download the app "Panasonic MAX Juke" to your Android device. Enter "Panasonic MAX Juke" in the search box of Google Play to search, and then select "Panasonic MAX Juke".

Note:

When recording, the DJ function is canceled.

DJ jukebox

[MEMORY], [USB A], [USB B]

This mode adds a crossfade effect or sample sound mix to the intervals between the tracks you play back.

This function works when you play back the tracks in the USB device or the internal memory.

1 Press [DJ JUKEBOX] on main unit.

- The setting of the unit switches to repeat mode automatically.
- (In the stop mode only) You can change the desired repeat setting by turning [MULTI CONTROL] on main unit.
 - RANDOM REPEAT
Play all tracks randomly.
 - ALL TITLE REPEAT
Repeat all tracks.
- When displayed "WAITING REQUEST" on the display, you can proceed to the next step without using the app "Panasonic MAX Juke".

2 Press [1] to [6] on main unit to select the desired function.

• [1]

Crossfade: The playback track volume gradually becomes small and next track volume becomes large.

• [2] to [6]

Sample Sound Mix: This effect is sounding a sample sound to the intervals between the tracks you play back.

To cancel, press the button again.

To cancel the DJ jukebox

Press [DJ JUKEBOX] on main unit.

Note:

- To change DJ jukebox function ON or OFF with the remote control
 - 1 Press [PLAY MENU] to select "JUKEBOX".
 - 2 Press [◀, ▶] to select "ON JUKEBOX" or "OFF JUKEBOX" and then press [OK].
- To change the desired repeat setting with the remote control
 - 1 Press [PLAY MENU] twice to select "PLAYMODE".
 - 2 Press [◀, ▶] to select desired mode and then press [OK].

If you use the app "Panasonic MAX Juke"

You can call up the tracks you want to play back through the app.

- When displayed "MAKING LIST" on the display, you can call up a part of tracks.
- When displayed "WAITING REQUEST" on the display, You can call up the tracks you want to play back through the app.

DJ sampler

By main unit only

By turning [MULTI CONTROL], you can apply a scratch sound or sample sound to the track you are playing back.

1 Press [DJ SAMPLER].

2 Press [1] to [6] to select the desired sound.

3 Turn [MULTI CONTROL].

To cancel the DJ sampler

Press [DJ SAMPLER].

If you use the app "Panasonic MAX Juke"

- You can change the sample sound on the app.
(To return all sample sounds to the factory preset, press and hold [DJ SAMPLER] when the DJ sampler is turned off.)

DJ effects

By main unit only

You can use the DJ effect function to add the sound effects.

- 1 Press [DJ EFFECT].
- 2 Press [1] to [6] to select the desired DJ effect.

- [1] PHASER
Add space and dimension to the sound.
- [2] FILTER
Enhance or filter specific ranges of the sound.
- [3] SOUND CHOPPER
Cut off the sound periodically.
- [4] ELECTRO ECHO
Add digital echo to the sound.
- [5] PITCH SHIFTER
Adjust the keys of the sound.
- [6] HARMONIZER
Add notes to the sound to create harmony.

To cancel, press the button again.

- 3 Turn [MULTI CONTROL] to select the desired setting.

To cancel the DJ effect
Press [DJ EFFECT].

Using a microphone

Preparation

Decrease the volume of the system to its minimum before you connect or disconnect a microphone.

- 1 Connect a microphone (not supplied) to the microphone jack.
Plug type: \varnothing 6.3 mm monaural
- 2 Turn [MIC VOL, MIN/MAX] on the main unit to adjust the volume of the microphone.
- 3 If you want to sing with the background music. Play the music source and adjust the volume of the system.

Note:

- If a strange noise (howling) is emitted, move the microphone away from the speakers, or decrease the volume of the microphone.
- When you do not use the microphone, disconnect it from the microphone jack, and decrease the volume of the microphone level to "MIN".
- This system cannot record from microphone.

Using the auxiliary input

Preparation

- Disconnect the AC power supply cord.
- Switch off all equipment and read the appropriate operating instructions.

Note:

Components and cables are sold separately.

To connect a portable audio equipment etc.

You can play music from a portable audio equipment.

Preparation

Switch off the equalizer (if any) of the portable audio equipment to prevent sound distortion. Decrease the volume of the system and the portable audio equipment before you connect or disconnect the portable audio equipment.

- 1 Connect the portable audio equipment to AUX IN 2.
Plug type: \varnothing 3.5 mm stereo (not supplied)
- 2 Press [RADIO/EXT-IN] to select "AUX 2".
- 3 Play the portable audio equipment.

To connect a VCR, DVD player etc.

You can connect a VCR, DVD player etc. and listen to the audio through this system.

Rear panel of this main unit

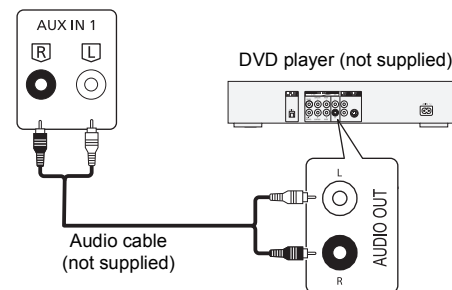

- 1 Connect the external equipment.
- 2 Press [RADIO/EXT-IN] to select "AUX 1".
- 3 Play the external equipment.

Note:

- If you want to connect equipment other than those described, refer to the audio dealer.
- Sound distortion can occur when you use an adapter.

Customer Service

Customer Service Directory

Obtain product information and operative assistant; localize the closer distributor or Service Center; buy spare parts and accessories by our web site to Latin American:

<http://www.lar.panasonic.com>

Also you may contact us directly by our Contact Center:

Panama	800-PANA (800-7262)
Colombia	01-8000-94PANA (01-8000-947262)
Ecuador	1800-PANASONIC (1800-726276)
Costa Rica	800-PANA737 (800-7262737)
El Salvador	800-PANA (800-7262)
Guatemala	1-801-811-PANA (1-801-811-7262)
Chile	800-390-602 From a cell phone: 797-5000
Venezuela	800-PANA-800 (800-7262-800)
Uruguay	0-800-PANA (0-800-7262)
Peru	0-800-00-PAN (0-800-00726)
Argentina	0800-333-PANA (0800-333-7262) 0810-321-PANA (0810-321-7262)
Paraguay	0800-11-PANA (0800-11-7262)
Dominican Republic	809-200-8000

Troubleshooting

Before requesting service, make the following checks. If you are in doubt about some of the check points, or if the solutions indicated do not solve the problem, consult your dealer for instructions.

Common problems

The unit does not work.

- One of the unit's safety devices may have been activated.

Reset the unit as follows:

- 1 Press [⏻/⏪] on the main unit to switch the unit to standby.
 - If the unit does not switch to standby, press [⏻/⏪] on the main unit for a few seconds. The unit is forcibly switched to standby. Alternatively, disconnect the AC power supply cord, wait one minute, then reconnect it.
- 2 Press [⏻/⏪] on the main unit to switch it on. If the unit still cannot be operated, consult the dealer.

The display panel lights up and changes continuously in standby mode.

- Press and hold [■] on the main unit to select "DEMO OFF".

No operations can be done with the remote control.

- Examine that the battery is installed correctly.

Sound is distorted or no sound.

- Adjust the volume of the system.
- Switch off the system, determine and correct the cause, then switch the system on again. It can be caused by straining of the speakers through excessive volume or power, and when using the system in a hot environment.

A humming sound can be heard during playback.

- An AC power supply cord or fluorescent light is near the cables. Keep other appliances and cords away from the cables of this system.

The sound level reduces.

- The protection circuit has been activated due to the continuous use at high volume output. This is to protect the system and maintain the sound quality.

Disc

Display not shown correctly.

Playback does not start.

- You have not put in the disc correctly. Put it in correctly.
- Disc is dirty. Clean the disc.
- Replace the disc if it is scratched, warped, or non-standard.
- There is condensation. Let the system dry for 1 to 2 hours.

The total number of tracks displayed is incorrect.

The disc cannot be read.

Distorted sound is heard.

- You put in a disc that the system cannot play. Change to a playable disc.
- You put in a disc that has not been finalized.

USB

The USB device or the contents in it cannot be read.

- The format of the USB device or the contents in it is/are not compatible with the system.
- USB devices with storage capacity of more than 32 GB cannot work in some conditions.

Slow operation of the USB device.

- Large content size or large memory USB device takes longer time to read.

Radio

Sound is distorted.

- Use an optional FM outdoor antenna. The antenna should be installed by a competent technician.

A beat sound is heard.

- Switch off the TV or move it away from the system.
- When in AM tuner mode, select from "BP 1" to "BP 4" that provides the best reception.

A low hum is heard during AM broadcasts.

- Move the antenna away from other cables and cords.

Bluetooth®

Pairing cannot be done.

- Check the Bluetooth® device condition.

The device cannot be connected.

- The pairing of the device was unsuccessful. Do pairing again.

- The pairing of the device has been replaced. Do pairing again.
- This system might be connected to a different device. Disconnect the other device and try pairing the device again.

The device is connected but audio cannot be heard through the system.

- For some built-in Bluetooth® devices, you have to set the audio output to “SC-MAX370” manually. Read the operating instructions of the device for details.

Sound from the device is interrupted.

- The device is out of the 10 m communication range. Move the device nearer to the system.
- Remove any obstacle between the system and the device.
- Other devices that use the 2.4 GHz frequency band (wireless router, microwaves, cordless phones, etc.) are interfering. Move the device nearer to the system and distance it from the other devices.
- Select “MODE 1” for stable communication.

The One-Touch Connection (NFC feature) is not working.

- Make sure the unit and the NFC feature of the device are turned on. (⇒ 13)

Main unit displays

“USB A NO DEVICE”

“USB B NO DEVICE”

- The USB device is not connected. Examine the connection.

“DEVICE FULL”

- You cannot do recording because the remaining recording time of the USB device is less than the total time of the music source. Change to a USB device which has enough recording time and do the recording again.

“ERROR”

- An incorrect operation was done. Read the instructions and try again.

“ERROR” (during recording)

- You cannot select other playback source (example: radio, USB etc.) or press [◀◀] or [▶▶] during recording. Stop the recording function.
- You cannot open the disc tray when recording from an AM source.

“F61”

- Examine and correct the speaker cords connection.
- Disconnect the USB device. Switch off the system and then switch it on again.

“F70”

- Examine the Bluetooth® device.
- Disconnect the Bluetooth® device. Switch off the system and then switch it on again.

“F77”

- Switch off the system and then switch it on again.

“NO PLAY”

“UNSUPPORT”

- Examine the content. You can only play supported format.
- The files in the USB device can be corrupted. Format the USB device and try again.
- The unit may have a problem. Turn the unit off and then on again.

“NO TRACK”

- There is no album or track in the USB device or the internal memory.

“PLAYERERROR”

- You played an unsupported MP3 file. The system will skip that track and play the next one.

“REMOTE 1”

“REMOTE 2”

- The remote control and the main unit are using different codes. Change the code of the remote control.
 - When “REMOTE 1” is shown, press and hold [OK] and [1] for a minimum of 4 seconds.
 - When “REMOTE 2” is shown, press and hold [OK] and [2] for a minimum of 4 seconds.

“TEMP NG”

- The temperature protection circuit has been activated, and the system will switch off. Let the unit cool down before switching it on again.
- Check that the ventilation opening of the unit is not obstructed.
- Ensure this unit is well ventilated.

“USB OVER CURRENT ERROR”

- The USB device is using too much power. Disconnect the USB device, switch off the system and then switch on again.

“VBR”

- The system cannot show the remaining play time for variable bit rate (VBR) tracks.

System memory reset (initialization)

Reset the memory when the following situations occur:

- There is no response when buttons are pressed.
- You want to clear and reset the memory contents.

1 Disconnect the AC power supply cord.

2 While you press and hold [⏻/⏪] on the main unit, connect the AC power supply cord again.

Continue to press and hold the button (approximately 10 seconds) until “- - - - -” is shown.

3 Release [⏻/⏪].

All the settings are set back to the factory preset. It is necessary to set the memory items again.

Remote control code

When other Panasonic equipment responds to the remote control of this system, change the remote control code for this system.

Preparation

Press [RADIO/EXT-IN] to select “AUX 1” or “AUX 2”.

To set the code to “REMOTE 2”

- 1 Press and hold [RADIO/EXT-IN] on the main unit and [2] on the remote control until “REMOTE 2” is shown.**
- 2 Press and hold [OK] and [2] for a minimum of 4 seconds.**

To set the code to “REMOTE 1”

- 1 Press and hold [RADIO/EXT-IN] on the main unit and [1] on the remote control until “REMOTE 1” is shown.**
- 2 Press and hold [OK] and [1] for a minimum of 4 seconds.**

Specifications

Amplifier section

RMS output power

Front	300 W per channel (3 Ω, 1 kHz, 30% THD)
Subwoofer (Mid-Low)	300 W per channel (3 Ω, 100 Hz, 30% THD)
Subwoofer (Low)	650 W per channel (6 Ω, 100 Hz, 30% THD)
Total RMS stereo mode power	2500 W

Disc section

Disc played

8 cm	CD, CD-R/RW
12 cm	CD, CD-R/RW

Pick up

Wavelength	790 nm (CD)
	Laser power CLASS 1

Audio output (disc)

	2.4 ch (FL, FR, SW)
FL = Front left channel	
FR = Front right channel	
SW = Subwoofer channel	

Format

CD-DA, MP3

Tuner section

Frequency modulation (FM)

Preset memory	30 stations
Frequency range	87.50 MHz to 108.00 MHz (50 kHz step)
Antenna terminals	75 Ω unbalanced

Amplitude modulation (AM)

Preset memory	15 stations
Frequency range	522 kHz to 1629 kHz (9 kHz step) 520 kHz to 1630 kHz (10 kHz step)

Speaker section

SB-MAF370PUK

Type 2 way, 3 speaker system (closed)

Speaker unit(s)

Woofer	10 cm cone type x2
Tweeter	6 cm cone type x1

Impedance

3 Ω

Output sound pressure

87 dB/W (1 m)

Frequency range

100 Hz to 30 kHz (-16 dB)
105 Hz to 27 kHz (-10 dB)

SB-MAY370PUK

Type 1 way, 1 speaker system (bass reflex)

Speaker unit(s)

Super Woofer (Mid-Low)	25 cm cone type
------------------------	-----------------

Impedance

3 Ω

Output sound pressure

87 dB/W (1 m)

Frequency range

25 Hz to 250 Hz (-16 dB)
30 Hz to 200 Hz (-10 dB)

SB-MAW370PUK

Type 1 way, 1 speaker system (bass reflex)

Speaker unit(s)

Super Woofer (Low)	25 cm cone type
--------------------	-----------------

Impedance

6 Ω

Output sound pressure

88 dB/W (1 m)

Frequency range

25 Hz to 250 Hz (-16 dB)
30 Hz to 200 Hz (-10 dB)

Bluetooth® section

Version

Bluetooth® Ver.2.1 + EDR

Output

Class 2 (2.5 mW)

Communication distance

Prospective communication distance: About 10 m*

Communication method

2.4 GHz band FH-SS

Correspondence profile

A2DP/AVRCP/SPP

* Prospective communication distance

Measurement environment: Temperature 25 °C/
Height 1.0 m

Measure in "MODE 1"

Memory section

Memory size

2 GB

Media file format support

MP3

Memory record

Bit rate	128 kbps
Memory recording speed	1x, 3x max (CD only)
From CD, MP3, USB recording file format	MP3 (*.mp3)

Terminals section

Microphone jack

Mono, Ø 6.3 mm

USB port

USB standard	USB 2.0 full speed
Media file format support	MP3 (*.mp3)
USB device file system	FAT12, FAT16, FAT32

USB ripping

Bit rate	128 kbps
Recording speed	1x, 3x max (CD only)
Recording file format	MP3 (*.mp3)

AUX input

Terminal	Stereo, Ø 3.5 mm jack Stereo, Pin jack
----------	---

General

Power supply

AC 110 V to 240 V, 50/60 Hz

SA-MAX370PUK

Power consumption

330 W

Dimensions (W x H x D)

492 mm x 221 mm x 421 mm

Mass

Approx. 7.1 kg

SB-MAF370PUK

Dimensions (W x H x D)

360 mm x 147 mm x 243 mm

Mass

Approx. 2.9 kg

SB-MAY370PUK

Dimensions (W x H x D)

360 mm x 402 mm x 310 mm

Mass

Approx. 8.2 kg

SB-MAW370PUK

Dimensions (W x H x D)

360 mm x 402 mm x 310 mm

Mass

Approx. 8.2 kg

Operating temperature range

0 °C to +40 °C

Operating humidity range

35% to 80% RH (no condensation)

Power consumption in standby mode

0.3 W (approximate)

Note:

- Specifications are subject to change without notice. Mass and dimensions are approximate.
- Total harmonic distortion is measured by the digital spectrum analyzer.

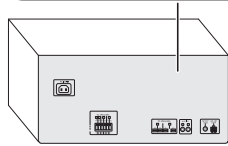

- If you see this symbol -

**Information on Disposal in other Countries
outside the European Union**



This symbol is only valid in the European Union.
If you wish to discard this product,
please contact your local
authorities or dealer and ask for
the correct method of disposal.

