

Panasonic®

Operating Instructions High Definition Video Camera

Model No. **HC-V700**
HC-V700M

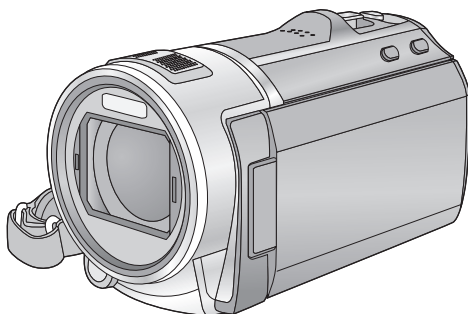

Before use, please read these instructions completely.

AVCHD™
Progressive

HDMI

SD™
XC

DOLBY
DIGITAL
STEREO CREATOR

VIERA
Link

3D

VQT3Y68

Information for Your Safety

■ About the recording format for recording motion pictures

You can record motion pictures in either AVCHD*¹ or iFrame recording formats using this unit. (→ 43, 56)

*1 It is compatible with the AVCHD Progressive (1080/50p).

AVCHD:

It is possible to record in the best image quality of this unit (1080/50p) and high definition image (1080/50i). It is suitable for viewing on a large format TV or for saving to disc*².

*2 To save the image recorded in 1080/50p, it is required to copy to a disc using the supplied software HD Writer AE 4.0.

iFrame:

This is a recording format suitable for viewing and editing on a Mac (iMovie'11). Using iMovie'11, iFrame motion pictures can be imported faster than AVCHD motion pictures. Also, the imported file size of iFrame motion pictures will be smaller than that of AVCHD motion pictures.

- It is not compatible with motion pictures recorded in AVCHD format.

■ Indemnity about recorded content

Panasonic does not accept any responsibility for damages directly or indirectly due to any type of problems that result in loss of recording or edited content, and does not guarantee any content if recording or editing does not work properly. Likewise, the above also applies in a case where any type of repair is made to the unit (including any other non-built-in memory related component).

■ Handling of built-in memory [HC-V700M]

This unit is equipped with the built-in memory. When using this component, pay attention to the following points.

Back up data periodically.

The built-in memory is temporary storage. In order to avoid erasing data due to static electricity, electromagnetic waves, breakage, and failures, back up the data to a PC or DVD disc. (→ 109, 122)

- Access lamp [ACCESS] (→ 8) illuminates while the SD card or built-in memory is being accessed (initialization, recording, playback, deleting etc.). Do not perform the following operations when the lamp illuminates. It may damage the built-in memory or cause a malfunction in the unit.
 - Turn the unit off (remove the battery)
 - Insert and remove the USB cable
 - Expose the unit to vibrations or shock
- About disposing of or giving away this unit. (→ 149)

■ About Condensation (When the lens or the LCD monitor is fogged up)

Condensation occurs when the ambient temperature or humidity changes. Be careful of condensation since it causes lens or LCD monitor stains, fungus and camera malfunction.





- For more details about the cause and action required for condensation, refer to page 153.

■ Cards that you can use with this unit

SD Memory Card, SDHC Memory Card and SDXC Memory Card

- 4 GB or more Memory Cards that do not have the SDHC logo or 48 GB or more Memory Cards that do not have the SDXC logo are not based on SD Memory Card Specifications.
- Refer to page 12 for more details on SD cards.

■ For the purposes of these operating instructions

- SD Memory Card, SDHC Memory Card and SDXC Memory Card are referred to as the “SD card”.
- Function that can be used for Motion Picture Recording Mode: 
- Function that can be used for Still Picture Recording Mode: 
- Function that can be used for the Playback Mode: 
- Function that can be used for the Playback Mode (motion pictures only): 
- Function that can be used for the Playback Mode (still pictures only): 
- Scene(s) recorded in 1080/50p, 1080/50i or side-by-side (SbS 3D): “AVCHD scene(s)”
- Pages for reference are indicated by an arrow, for example: → 00

These operating instructions are designed for use with models **HC-V700** and **HC-V700M**. Pictures may be slightly different from the original.

- The illustrations used in these operating instructions show model **HC-V700**, however, parts of the explanation refer to different models.
- Depending on the model, some functions are not available.
- Features may vary, so please read carefully.
- Not all models may be available depending on the region of purchase.

Contents

Information for Your Safety.....	2
----------------------------------	---

Preparation

Names and Functions of Main Parts	6
Power supply.....	9
Inserting/removing the battery.....	9
Charging the battery	10
Charging and recording time.....	11
Recording to a card	12
Cards that you can use with this unit	12
Inserting/removing an SD card.....	13
Turning the unit on/off.....	14
Selecting a mode	15
How to use the touch screen	15
About the Touch Menu	16
Setting date and time.....	17

Basic

Before recording.....	18
Selecting a media to record [HC-V700M].....	19
Recording motion pictures	20
Recording still pictures	22
Recording still pictures in Motion Picture Recording Mode.....	24
Intelligent Auto Mode	25
Motion picture/Still picture playback	27
Using the menu screen	30
Using the Setup Menu	31

Advanced (Recording)

Using the zoom	40
Zoom ratio during the Still Picture Recording Mode	41
Image Stabilizer Function	42
1080/50p recording	43
Recording with the Touch Function.....	44
Touch function icons	44
Recording functions of operation icons	47
Operation icons.....	47
Recording functions of menus.....	54
Manual recording	69
White Balance.....	70
Manual shutter speed/ iris adjustment.....	71
Manual Focus adjustment.....	72
Recording 3D image	73

Advanced (Playback)

Playback Operations	76
Motion picture playback	
using operation icon	76
Creating still picture	
from motion picture	77
Highlight & Time Frame Index.....	78
Repeat Playback	78
Resuming the previous playback	79
Zooming in on a still picture during	
playback (Playback zoom)	79
Various playback functions	80
Playing back motion pictures/ still pictures by date	80
Highlight Playback	81
Changing the playback settings and playing back the slide show	87
Deleting scenes/still pictures	89
Deleting part of a scene (AVCHD)	91
Dividing a scene (AVCHD)	92
Dividing a scene to partially delete (iFrame/MP4)	93
Deleting personal information	94
Protecting scenes/still pictures	94
Relay scene combining	
[HC-V700M]	95
Watching Video/Pictures on your TV	97
Connecting with a HDMI mini cable	100
Connecting with the AV multi cable	100
Playback using VIERA Link	101
3D image playback	103
Converting and playing back	
2D images as 3D	104

Copy/Dubbing

Copying between SD card and Built-in Memory [HC-V700M]	106
Connecting a DVD burner to copy to/ play back a disc	109
Preparing for copying/ playing back	109
Copying to discs	111
Playing back the copied disc	114
Managing the copied disc	115
Dubbing with a Blu-ray disc recorder, video device, etc.	116
3D image storage	120

With a PC

What you can do with a PC	122
End User License Agreement	125
Operating environment	127
Installation	130
Connecting to a PC	131
About the PC display	133
Starting HD Writer AE 4.0	134
Reading the operating instructions of the software applications	134
If using Mac	135

Others

Indications	137
Messages	140
About recovery	141
Troubleshooting	142
Cautions for use	148
About copyright	154
Recording modes/approximate recordable time	155
Approximate number of recordable pictures	156
Optional accessories	157

Names and Functions of Main Parts

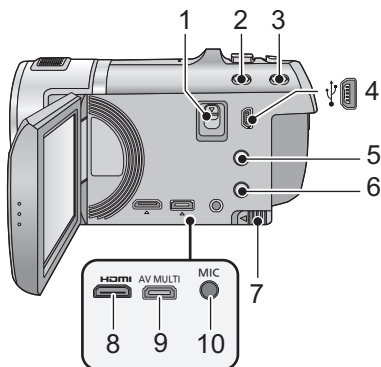



- 1 Shoe adaptor release lever [SHOE ADAPTOR RELEASE] (→ 157)
- 2 Intelligent auto/Manual button [iA/MANUAL] (→ 25, 69)
- 3 Optical image stabilizer button [((())) O.I.S.] (→ 42)
- 4 USB terminal [ψ] (→ 110, 117, 131)
- 5 1080/50p button [1080/50p] (→ 43)
- 6 Power button [⏻/⏷] (→ 14)
- 7 Battery release lever [BATT] (→ 9)
- 8 HDMI mini connector [HDMI] (→ 97, 101)
- 9 AV multi connector [AV MULTI] (→ 97, 119)

- Use the AV multi cable (only the supplied cable).

10 Microphone terminal [MIC]

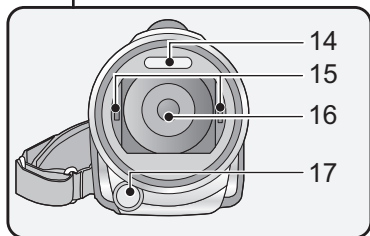
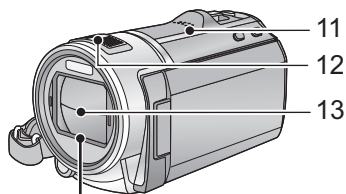
- A compatible plug-in powered microphone can be used as an external microphone.
- Audio will be stereo (2 ch) with the external microphone input.
- □□□■■■■■ (Microphone input level meter) is displayed when the external microphone is connected. (→ 63)
- When the unit is connected with the AC adaptor, sometimes noise may be heard depending on the microphone type. In this case, please switch to the battery for the power supply and the noise will stop.



- 11 Speaker
- 12 Internal stereo microphones
- 13 Lens cover
 - The lens cover opens in  Motion Picture Recording Mode or  Still Picture Recording Mode. (→ 15)
- 14 Built-in flash (→ 50)
- 15 Step up ring attachment part (concave) (→ 73)
- 16 Lens
- 17 Video light (→ 53, 68)

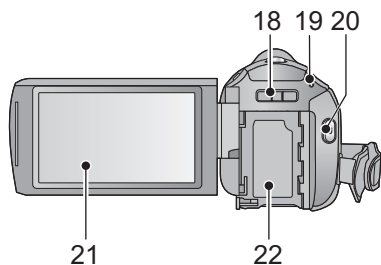

- 18 Shoe adaptor mounting part [SHOE ADAPTOR] (→ 157)
- 19 Status indicator (→ 14)
- 20 Recording start/stop button (→ 20)
- 21 LCD monitor (Touch screen) (→ 15)

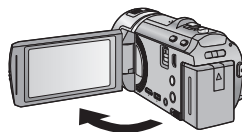

- It can open up to 90°.

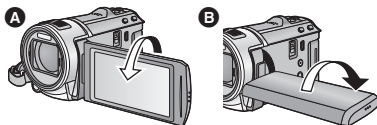

- It can rotate up to 180° **A** towards the lens or 90° **B** towards the opposite direction.

Due to limitations in LCD production technology, there may be some tiny bright or dark spots on the LCD monitor screen. However, this is not a malfunction and does not affect the recorded picture.

- 22 Battery holder (→ 9)

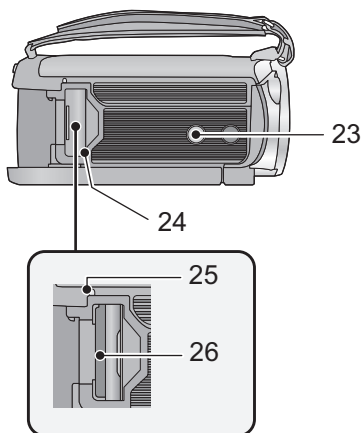

23 Tripod receptacle

- If you attach a tripod which has 5.5 mm screw or larger, it may damage this unit.

24 SD card cover (→ 13)

25 Access lamp [ACCESS] (→ 13)

26 Card slot (→ 13)

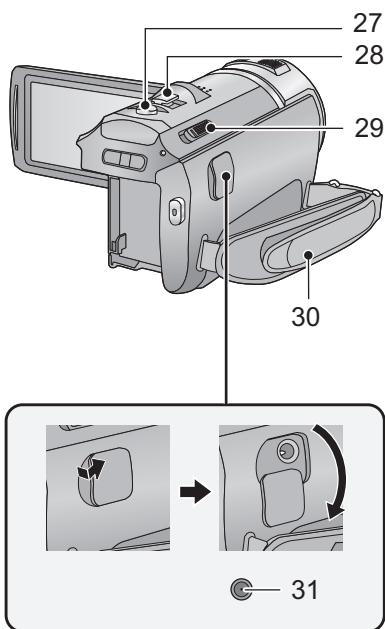

27 Photoshot button [] (→ 22)

28 Zoom lever [W/T] (In Motion Picture Recording Mode or Still Picture Recording Mode) (→ 40)

Thumbnail display switch [/] / Volume lever [-VOL+] (In Playback Mode) (→ 28)

29 Mode switch (→ 15)

30 Grip belt

Adjust the length of the grip belt so that it fits your hand.

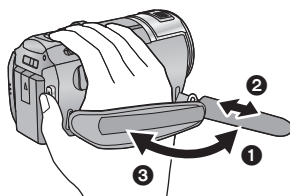

1 Flip the belt.

2 Adjust the length.

3 Replace the belt.

31 DC input terminal [DC IN] (→ 10)

- Do not use any other AC adaptors except the supplied one.

Power supply

■ About batteries that you can use with this unit

The battery that can be used with this unit is VW-VBK180/VW-VBK360.

- The unit has a function for distinguishing batteries which can be used safely. The dedicated battery (VW-VBK180/VW-VBK360) supports this function. The only batteries suitable for use with this unit are genuine Panasonic products and batteries manufactured by other companies and certified by Panasonic. (Batteries which do not support this function cannot be used). Panasonic cannot in any way guarantee the quality, performance or safety of batteries which have been manufactured by other companies and are not genuine Panasonic products.

It has been found that counterfeit battery packs which look very similar to the genuine product are made available to purchase in some markets. Some of these battery packs are not adequately protected with internal protection to meet the requirements of appropriate safety standards. There is a possibility that these battery packs may lead to fire or explosion. Please be advised that we are not liable for any accident or failure occurring as a result of use of a counterfeit battery pack. To ensure that safe products are used we would recommend that a genuine Panasonic battery pack is used.

Inserting/removing the battery

- Press the power button to turn off the unit. (→ 14)

Install the battery by inserting it in the direction shown in the figure.

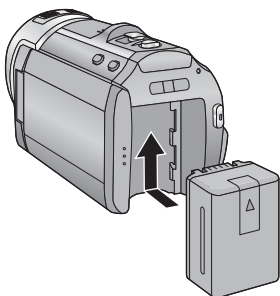

Insert the battery until it clicks and locks.

Removing the battery

Be sure to hold down the power button until the status indicator goes off. Then remove the battery while supporting the unit to prevent it from dropping.

Move the battery release lever in the direction indicated by the arrow and remove the battery when unlocked.

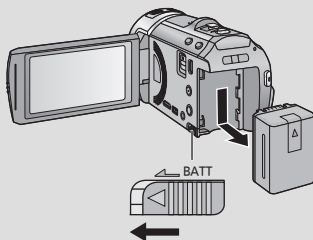

Charging the battery

When this unit is purchased, the battery is not charged. Charge the battery fully before using this unit for the first time.

The unit is in the standby condition when the AC adaptor is connected. The primary circuit is always “live” as long as the AC adaptor is connected to an electrical outlet.

Important:

- Use the supplied AC adaptor. Do not use the AC adaptor of another device.
- Do not use the AC cable with any other equipment as it is designed only for this unit. Also, do not use the AC cable from other equipment with this unit.
- The battery will not be charged if the unit is turned on.
- It is recommended to charge the battery in a temperature between 10 °C and 30 °C. (The battery temperature should also be the same.)

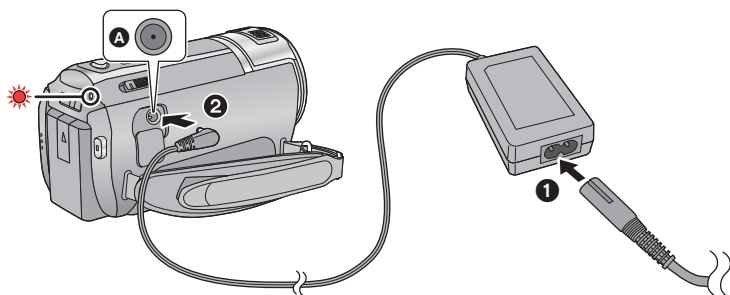

A DC input terminal

- Insert the plugs as far as they will go.

1 Connect the AC cable to the AC adaptor, then the AC outlet.

2 Connect the AC adaptor to the DC input terminal.

- Be careful not to pinch the DC input terminal cover.
- The status indicator will flash red at an interval of 2 seconds (approximately 1 second on, 1 second off), indicating that charging has begun. It will turn off when the charging is completed.

■ Connecting to the AC outlet

It is possible to use this unit with power supplied from the AC outlet by turning on the unit with the AC adaptor connected.

Use it together with the battery when recording for long time the AC adaptor connected.

■ To charge by connecting to other device

It is possible to charge by connecting to other device with the USB cable (supplied). Please refer to page 132.

- If the status indicator flashes at a particularly fast or slow rate, refer to page 150.
- We recommend using Panasonic batteries (→ 11).

- If you use other batteries, we cannot guarantee the quality of this product.
- Do not heat or expose to flame.
- Do not leave the battery(ies) in a car exposed to direct sunlight for a long period of time with doors and windows closed.

Charging and recording time

■ Charging/Recording time

- Temperature: 25 °C/humidity: 60%RH
- Charging times in parentheses are when charging from the USB terminal.

Battery model number [Voltage/Capacity (minimum)]	Charging time	Recording mode	Maximum continuously recordable time	Actual recordable time
Supplied battery/ VW-VBK180 (optional) [3.6 V/1790 mAh]	2 h 25 min (5 h 45 min)	[1080/50p]	1 h 20 min	40 min
		[HA],[HG]	1 h 25 min	45 min
		[HX],[HE]	1 h 30 min	
		[iFrame]	1 h 35 min	
VW-VBK360 (optional) [3.6 V/3580 mAh]	4 h 20 min (10 h 40 min)	[1080/50p]	2 h 50 min	1 h 30 min
		[HA]	3 h	1 h 35 min
		[HG],[HX], [HE]	3 h 5 min	
		[iFrame]	3 h 15 min	



- These times are approximations.
- **The indicated charging time is for when the battery has been discharged completely. Charging time and recordable time vary depending on the usage conditions such as high/low temperature.**
- Recordable time of 3D recording mode is the same. (During 3D recording mode, 1080/50p and iFrame recording mode cannot be used.)

- The actual recordable time refers to the recordable time when repeatedly starting/stopping recording, turning the unit on/off, moving the zoom lever etc.
- The batteries heat up after use or charging. This is not a malfunction.

Battery capacity indication

- The display changes as the battery capacity reduces.



If there is less than 3 minutes remaining, then  will become red. If the battery discharges, then  will flash.

- Screen display will disappear when no touch operation is performed for a specific period of time. However, it will be constantly displayed when the remaining battery time becomes less than 30 minutes.
- The remaining battery capacity is displayed when using the Panasonic battery that you can use for this unit. The actual time can vary depending on your actual use.
- When using the AC adaptor or batteries made by other companies, the remaining battery capacity will not be shown.

Recording to a card

The unit can record still pictures or motion pictures to an SD card or built-in memory. To record to an SD card, read the following.

This unit (an SDXC compatible device) is compatible with SD Memory Cards, SDHC Memory Cards and SDXC Memory Cards. When using an SDHC Memory Card/SDXC Memory Card with other equipment, check the equipment is compatible with these Memory Cards.

Cards that you can use with this unit

Use SD cards conforming to Class 4 or higher of the SD Speed Class Rating* for motion picture recording.

Card type	Capacity
SD Memory Card	512 MB/1 GB/2 GB
SDHC Memory Card	4 GB/6 GB/8 GB/12 GB/16 GB/24 GB/32 GB
SDXC Memory Card	48 GB/64 GB

* SD Speed Class Rating is the speed standard regarding continuous writing. Check via the label on the card, etc.

e.g.:



- Please confirm the latest information about SD Memory Cards/SDHC Memory Cards/SDXC Memory Cards that can be used for motion picture recording on the following website.

http://panasonic.jp/support/global/cs/e_cam

(This website is in English only.)

- Operation of the SD Memory Cards 256 MB or less is not guaranteed. Also, the SD Memory Card 32 MB or less cannot be used for the motion picture recording.
- 4 GB or more Memory Cards that do not have the SDHC logo or 48 GB or more Memory Cards that do not have the SDXC logo are not based on SD Memory Card Specifications.
- The operation of Memory Cards exceeding 64 GB cannot be guaranteed.
- When the write-protect switch **A** on SD card is locked, no recording, deletion or editing will be possible on the card.
- Keep the Memory Card out of reach of children to prevent swallowing.



Inserting/removing an SD card

When using an SD card not from Panasonic, or one previously used on other equipment, for the first time on this unit, format the SD card. (→ 37) When the SD card is formatted, all of the recorded data is deleted. Once the data is deleted, it cannot be restored.

Caution:

Check that the access lamp has gone off.

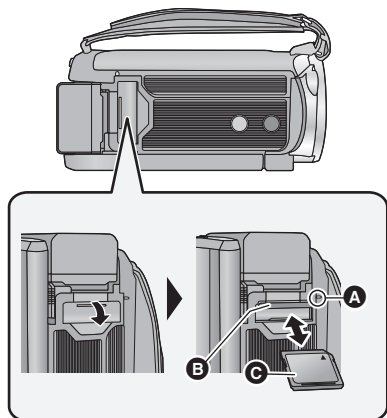

Access lamp [ACCESS] **A**

- When this unit is accessing the SD card or built-in memory, the access lamp lights up.

1 Open the SD card cover and insert (remove) the SD card into (from) the card slot **B**.

- Face the label side **C** in the direction shown in the illustration and press it straight in as far as it will go.
- Press the centre of the SD card and then pull it straight out.

2 Securely close the SD card cover.

- Securely close it until it clicks.

- Do not touch the terminals on the back of the SD card.
- Do not apply strong shocks, bend, or drop the SD card.
- Electrical noise, static electricity or the failure of this unit or the SD card may damage or erase the data stored on the SD card.
- When the card access lamp is lit, do not:
 - Remove the SD card
 - Turn the unit off
 - Insert and remove the USB cable
 - Expose the unit to vibrations or shockPerforming the above while the lamp is on may result in damage to data/SD card or this unit.
- Do not expose the terminals of the SD card to water, dirt or dust.
- Do not place SD cards in the following areas:
 - In direct sunlight
 - In very dusty or humid areas
 - Near a heater
 - Locations susceptible to significant difference in temperature (condensation can occur.)
 - Where static electricity or electromagnetic waves occur
- To protect SD cards, return them to their cases when you are not using them.
- About disposing of or giving away the SD card. (→ 152)

Turning the unit on/off

You can turn the unit on and off using the power button or by opening and closing the LCD monitor.

Turning the unit on and off with the power button

Open the LCD monitor and press the power button to turn on the unit.

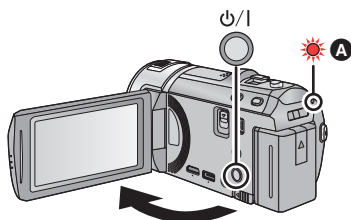

To turn off the unit

Hold down the power button until the status indicator goes off.

A The status indicator lights on.

Turning the unit on and off with the LCD monitor

The unit is turned on when the LCD monitor is opened, and unit is turned off when it is closed.

During normal use, opening and closing of the LCD monitor can be conveniently used to turn the unit on/off.

■ To turn on the unit

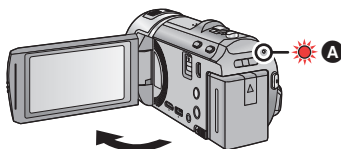

A The status indicator lights on.

■ To turn off the unit

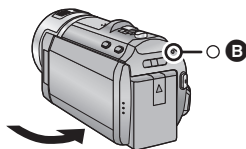

B The status indicator goes off.



- The unit will not turn off while recording motion pictures even if the LCD monitor is closed.
- In the following cases, opening the LCD monitor does not turn on the unit. Press the power button to turn on the unit.
 - When the unit is originally purchased
 - When you have turned off the unit using the power button
- To turn off the unit while connecting an external microphone with the MIC terminal, press the power button.

Selecting a mode

Change the mode to recording or playback.

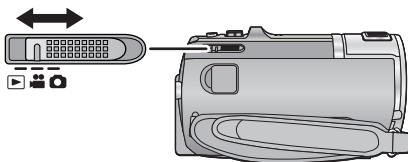
Operate the mode switch to change the mode to  ,  or  .



	Motion Picture Recording Mode (→ 20)
	Still Picture Recording Mode (→ 22)
	Playback Mode (→ 27, 76)

How to use the touch screen

You can operate by directly touching the LCD monitor (touch screen) with your finger.

■ Touch

Touch and release the touch screen to select icon or picture.

- Touch the centre of the icon.
- Touching the touch screen will not operate while you are touching another part of the touch screen.

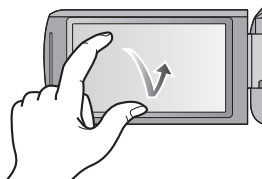

■ Slide while touching

Move your finger while pressing on the touch screen.

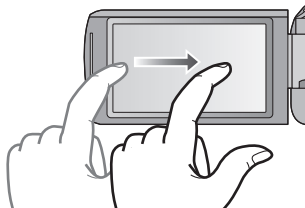

■ About the operation icons



These icons are used to switch the menu and thumbnail display page, for item selection and setting etc.



Touch to return to the previous screen such as when setting menus.



About the Touch Menu

Touch ◀ (left side)/▶ (right side) of  on the Touch Menu to switch the operation icons.

Touch ◀ (left side)/▶ (right side) of  on the Touch Menu.

- It is also possible to switch the operation icons by sliding the Touch Menu right or left while touching it.

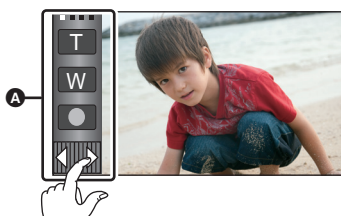

Recording Mode

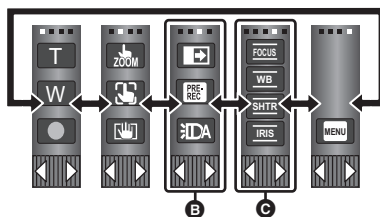

Playback Mode

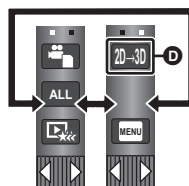

- B** You can change the operation icons to display. (→ 35)
- C** Displayed only during the Manual Mode. (→ 69)
- D** Displayed only when connected to a TV. (→ 104)

■ To display the Touch Menu



Display of the Touch Menu will disappear when no touch operation is performed for a specific period of time. To display it again, touch .

- Do not touch the LCD monitor with hard pointed tips, such as ball point pens.

Preparation



Setting date and time

When the unit is turned on for the first time, a message asking you to set the date and time will appear.

Select [YES] and perform steps 2 to 3 below to set the date and time.

1 Select the menu. (→ 30)

: [SETUP] → [CLOCK SET]

2 Touch the date or time to be set, then set the desired value using / .

A Displaying the World time setting (→ 31):

[HOME] / [DESTINATION]

- The year can be set between 2000 and 2039.
- The 24-hour system is used to display the time.



3 Touch [ENTER].

- A message prompting for World Time setting may be displayed. Perform the World Time setting by touching the screen. (→ 31)
- Touch [EXIT] to complete the setting.

- The date and time function is driven by a built-in lithium battery.
- If the time display becomes [- -], the built-in lithium battery needs to be charged. To recharge the built-in lithium battery, connect the AC adaptor or attach the battery to this unit. Leave the unit as it is for approx. 24 hours and the battery will maintain the date and time for approx. 4 months. (The battery is still being recharged even if the unit is off.)

Before recording

■ Basic camera positioning

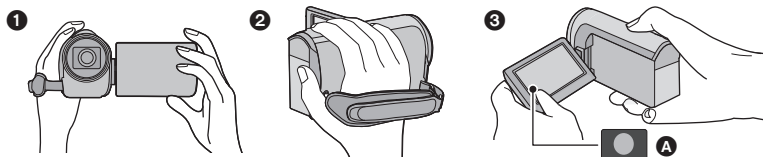

- ❶ Hold the unit with both hands.
 - ❷ Put your hand through the grip belt.
 - ❸ It is convenient to use the recording button icon **A** when holding the unit around your waist.
- When recording, make sure your footing is stable and there is no danger of colliding with another person or object.
 - When you are outdoors, record pictures with the sunlight behind you. If the subject is backlit, it will become dark in the recording.
 - Keep your arms near your body and separate your legs for better balance.
 - Do not cover the microphones with your hand etc.

■ Basic motion picture recording

- The unit should normally be held steady when recording.
- If you move the unit when recording, do so slowly, maintaining a constant speed.
- The zoom operation is useful for recording subjects you cannot get close to, but overuse of zoom in and zoom out can make the resulting motion picture less enjoyable to watch.

■ Recording Yourself

Rotate the LCD monitor towards the lens side.

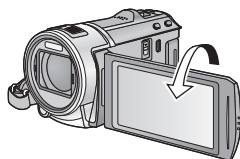

- The image is horizontally flipped as if you see a mirror image. (However the image recorded is the same as a normal recording.)
- Only some indications will appear on the screen. When  appears, return the direction of the LCD monitor to normal position and check the warning/alarm indication. (→ 140)





Selecting a media to record [HC-V700M]

The card and built-in memory can be selected separately to record motion pictures or still pictures.

- 1** Change the mode to  or .
- 2** Select the menu. (→ 30)

 : [MEDIA SELECT]

- 3** Touch the media to record motion pictures or still pictures.

- The media is selected separately to motion pictures or still pictures is highlighted in yellow.

- 4** Touch [ENTER].

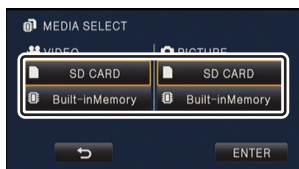



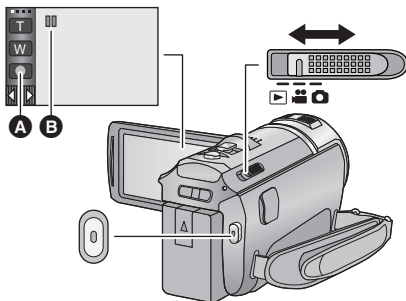

Recording motion pictures

- 1 Change the mode to .
- 2 Open the LCD monitor.
- 3 Press the recording start/stop button to start recording.



- A Recording button icon
- B When you begin recording,  changes to .

- Recording can also be started/stopped by touching the recording button icon. This icon functions in the same manner as the recording start/stop button.

- 4 Press the recording start/stop button again to pause recording.

■ Screen indications in the Motion Picture Recording Mode

	Recording mode
R 1h20m	Approximate remaining recordable time <ul style="list-style-type: none"> • When the remaining time is less than 1 minute, R 0h00m flashes red.
0h00m00s	Recording time elapsed <ul style="list-style-type: none"> • "h" is an abbreviation for hour, "m" for minute and "s" for second. • Each time the unit is put into recording pause, the counter display will be reset to 0h00m00s.



- Screen display will disappear when no touch operation is performed for a specific period of time. To display it again, touch the screen. (→ 31)
- It will be constantly displayed when the remaining recordable time becomes less than 30 minutes.

- To change the recording format, change the Recording Mode (→ 56) or press and hold the 1080/50p button. (→ 43)
- Still pictures can be recorded while recording the motion picture. (→ 24)
- The images recorded between pressing the recording start/stop button to start recording and pressing it again to pause recording become one scene.
When you record with the [REC MODE] set to [iFrame], the scenes longer than approximately 20 minutes will be automatically divided. (Recording will continue.)
- (Maximum recordable scenes of a single SD card or built-in memory)

Recording formats	[1080/50p]/[HA]/[HG]/[HX]/[HE]	[iFrame]
Recordable scenes	Approx. 3900	Approx. 89100
Different dates (→ 80)	Approx. 900	Approx. 900

- Maximum number of recordable scenes and maximum number of different dates will be less than above table when there are both iFrame scenes and still pictures recorded on an SD card or the built-in memory.
- While recording is in progress, the recording will not stop even if the LCD monitor is closed.
- Put the unit in Pause mode when connecting or disconnecting an external microphone with the MIC terminal.
- Please refer to page 155 about approximate recordable time.

About the compatibility of the recorded motion pictures

When motion picture is recorded in AVCHD Progressive format

- Only motion pictures recorded with the recording format set to AVCHD Progressive are supported by AVCHD Progressive compatible equipment.
- It is not always possible to play back motion pictures recorded with the recording format set to AVCHD Progressive on AVCHD Progressive compatible equipment. In such a case, play back on this unit instead.

When motion picture is recorded in AVCHD format

- Only motion pictures recorded with the recording format set to AVCHD are supported by AVCHD compatible equipment. Images cannot be played with equipment that does not support AVCHD (ordinary DVD recorders). Confirm that your equipment supports AVCHD by referring to the operating instructions.
- It is not always possible to play back motion pictures recorded with the recording format set to AVCHD on AVCHD compatible equipment. In such a case, play back on this unit instead.

When motion picture is recorded in iFrame format

- You can play back on a Mac (iMovie'11).
- It is not compatible with motion pictures recorded in AVCHD format.
- It is not always possible to play back motion pictures recorded with the recording format set to iFrame on iFrame compatible equipment. In such a case, play back on this unit instead.



Recording still pictures

- 1 Change the mode to .
- 2 Open the LCD monitor.
- 3 Press the button halfway.
(For Auto Focus only)

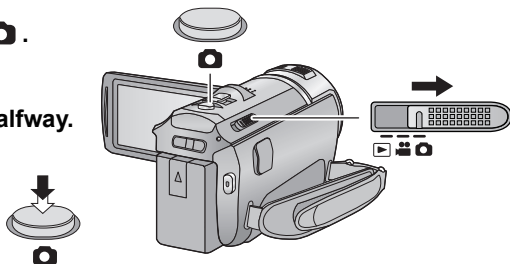

Focus indication:

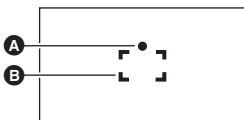







- A Focus indication:
 - (The white lamp flashes.): Focusing
 - (The green lamp lights up.): When in focus
 - No mark: When focusing is unsuccessful.
- B Focus area (area inside brackets)

- 4 Press the button fully.



- If you set the Optical Image Stabilizer function (→ 42) to 1 ([MODE1]), then the Image Stabilizer function will be more effective. (MEGA) (MEGA Optical Image Stabilizer) will be displayed when the button is pressed halfway.)
- In dark environments, the video light will turn on.
- Using a flash or tripod is recommended when recording still pictures in dark places because the shutter speed becomes slow.
- You can also take a picture just by touching the subject to focus. (Touch Shutter: → 46)
- To print a picture, save the picture to the SD card (→ 106) and print using a PC or a printer.

■ About the screen indications in Still Picture Recording

	Still picture operation indicator (→ 137)
R3000	Remaining number of still pictures (Flashes in red when [0] appears.)
	Size of still pictures (→ 65)
	MEGA optical image stabilizer (→ 22)
	Optical Image Stabilizer (→ 42)
AF*	AF assist lamp (→ 68)
	Flash (→ 50)
	Flash level (→ 50)
	Red-eye Reduction (→ 50)



- Screen display will disappear when no touch operation is performed for a specific period of time. To display it again, touch the screen.
- It will be constantly displayed when the remaining number of still pictures that can be recorded becomes 200 or less.

■ About the focus indication

- The focus indication indicates the status of the Auto Focus.
- The focus indication does not appear in Manual Focus Mode.
- The focus indication does not appear or has difficulty focusing in the following cases.
 - When close subjects and far subjects are included in the same scene
 - When the scene is dark
 - When there is a bright part in the scene
 - When the scene is filled with only horizontal lines

■ About the focusing area

When there is a contrasting object ahead or behind the subject in the focus area, the subject may not be focused. If so, move the contrasting object out of the focus area.

- Focus area is not displayed in the following conditions.
 - When the Intelligent Auto Mode (Portrait) is used
 - When AF/AE tracking is used
 - When the Extra Optical Zoom is used
 - When the unit determines that the AF assist lamp is necessary

Recording still pictures in Motion Picture Recording Mode

You can record still pictures even in Motion Picture Recording Mode.

◇ Change the mode to  .

Press the  button fully (press to the bottom) to take the picture.

- It is possible to record still pictures while recording motion pictures.
(Simultaneous recording)
- Remaining number of recordable pictures is displayed while still pictures are being recorded.



-
- Built-in flash, Red-eye Reduction, self-timer (→ 51) do not work.
 - While recording motion pictures or during the PRE-REC operation, image quality is different from ordinary still pictures so that motion picture recording takes preference over still picture recording.
 - If simultaneous recording is used while recording a motion picture, the recordable time remaining will shorten. If the unit is turned off or the mode switch operated, the recordable time remaining may lengthen.

Intelligent Auto Mode



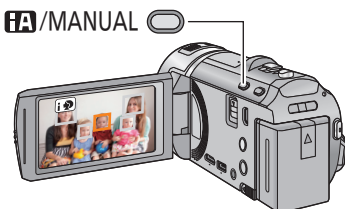





The following modes (appropriate for the condition) are set just by pointing the unit to what you want to record.



Intelligent auto/Manual button

Press this button to switch Intelligent Auto Mode/Manual Mode.

- Please refer to page 69 about Manual Mode.

Mode		Effect
	Portrait	Faces are detected and focused automatically, and the brightness is adjusted so it is recorded clearly.
	Scenery	The whole landscape will be recorded vividly without whiting out the background sky, which may be very bright.
 *1	Spotlight	Very bright object is recorded clearly.
 *1	Low light	It can record very clearly even in a dark room or twilight.
 *2	Night portrait	A subject and the background are recorded with near real-life brightness.
 *2	Night scenery	You can record night scenery vividly by slowing the shutter speed.
 *2	Macro	This allows recording at very close proximity to the object of recording.
 *1  *2	Normal	In modes other than those described above, the contrast is adjusted to give a clear picture.

*1 In Motion Picture Recording Mode only

*2 In Still Picture Recording Mode only

- Depending on the recording conditions, the unit may not enter the desired mode.
- In the Portrait, Spotlight, or Low Light Mode, the face will be surrounded by a white frame when detected. In the Portrait Mode, a subject that is bigger and close to centre of the screen will be surrounded by an orange frame. (→ 60)
- Using a tripod is recommended in Night Portrait and Night Scenery Mode.
- Faces cannot be detected depending on the recording conditions, such as when faces are of certain sizes or at certain tilts or when digital zoom is used.

■ Intelligent Auto Mode

When switching to Intelligent Auto Mode, the Auto White Balance and Auto Focus operate and automatically adjust the colour balance and focusing.

Depending on the brightness of the subject etc., the aperture and shutter speed are automatically adjusted for an optimum brightness.

- Colour balance and focus may not be adjusted automatically depending on light sources or scenes. If so, manually adjust these settings. (→ 70, 72)

Automatic White Balance

The illustration shows the range over which Automatic White Balance functions.

- 1) The effective range of Automatic White Balance adjustment on this unit
- 2) Blue sky
- 3) Cloudy sky (rain)
- 4) Sunlight
- 5) White fluorescent lamp
- 6) Halogen light bulb
- 7) Incandescent light bulb
- 8) Sunrise or sunset
- 9) Candlelight

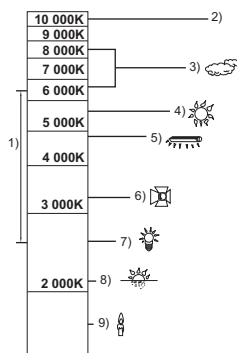

If the Automatic White Balance is not functioning normally, adjust the White Balance manually. (→ 70)

Auto Focus

The unit focuses automatically.

- Auto Focus does not work correctly in the following situations. Record pictures in the Manual Focus Mode. (→ 72)
 - Recording distant and close-up objects at the same time
 - Recording a subject behind dirty or dusty window
 - Recording a subject that is surrounded by objects with glossy surfaces or by highly reflective objects

Motion picture/Still picture playback

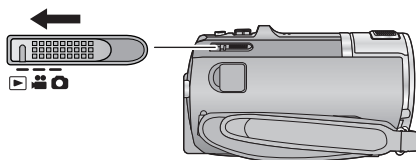

- 1 Change the mode to .
- 2 Touch the play mode select icon **A**. (→ 16)



- 3 **HC-V700**
Select the still picture **B** or the recording format of the motion picture **C** you wish to play back.



HC-V700M

- 3 Select the media type **D** and then select the still picture **B** or the recording format of the motion picture **C** you wish to play back.



- Touch [ENTER].
- The icon is displayed in the thumbnail display when the item for motion picture is touched.
(**AVCHD**, **1080/50p**, **1080/50i**, **Sbs 3D**, **iFrame** and **MP4**)
- **50p** is displayed in the 1080/50p scene and **3D** is displayed in the side-by-side scenes when [ALL AVCHD] is touched.

- 4 Touch the scene or the still picture to be played back.

- It will switch to the screen displaying and thumbnail scroll lever **E** when no operation is performed for approximately 5 seconds in the thumbnail display screen.
For details about deleting, refer to page 89.
- To display the next (previous) page:
 - Slide the thumbnail display upward (downward) while touching it.
 - Touch **▲** (up) / **▼** (down) of the thumbnail scroll lever.



5 Select the playback operation by touching the operation icon.

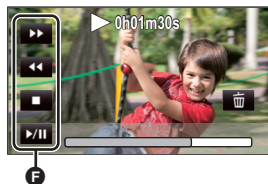

F Operation icon

- Operation icons and screen display will disappear when no touch operation is performed for a specific period of time. To display them again, touch the screen.
- It will be played back in 2D only or 3D only when slide show is played back connected to the 3D compatible TV. It will be played back in 2D if the still picture at the start of the slide show is 2D (3D still pictures are converted to 2D still pictures and played back), and it will be played back in 3D if it is 3D (2D still pictures are converted to 3D still pictures and played back).

Motion picture playback	Still picture playback
<p>▶/ : Playback/Pause</p> <p>◀◀: Rewind playback</p> <p>▶▶: Fast forward playback</p> <p>■: Stops the playback and shows the thumbnails.</p>	<p>▶/ : Slide show (playback of the still pictures in numerical order) start/pause.</p> <p>◀ : Plays back the previous picture.</p> <p> ▶: Plays back the next picture.</p> <p>■: Stops the playback and shows the thumbnails.</p>

■ Change the thumbnail display

While the thumbnail is displayed, the thumbnail display changes in the following order if the zoom lever is operated to side or side.

20 scenes ↔ 9 scenes ↔ 1 scene ↔ Highlight & Time Frame Index* (→ 78)

* Highlight & Time Frame Index can only set in Motion Picture Playback Mode.

- 9 scenes display returns if the unit is turned off or the mode is changed.
- By displaying in 1 scene or touching and holding the thumbnail in the 20 scenes or 9 scenes display, recording date and time are displayed when playing back motion pictures, and recording date and file number when playing back still pictures.

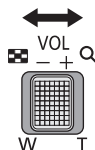

■ Speaker volume adjustment

Operate the volume lever to adjust the speaker volume during Motion Picture Playback Mode.

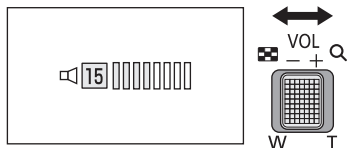

Towards “+”: Increases the volume

Towards “-”: Decreases the volume

-
- Sound will be heard only during normal playback.
 - If pause play is continued for approx. 5 minutes, the screen returns to the thumbnails.
 - The elapsed time for playback indication will be reset to 0h00m00s each scene.
 - When played back with [ALL AVCHD] selected, the screen may become black momentarily at the time the scene switches.

Motion picture compatibility

- This unit is based on AVCHD Progressive/AVCHD format/MPEG-4 AVC file format.

AVCHD Progressive format

- Video signal for the AVCHD Progressive that can be played back with this unit is 1920×1080/50p.
- This unit may degrade or not play back motion pictures recorded or created on other products, and other products may degrade or not play back motion pictures recorded on this unit, even if the products support AVCHD Progressive.

AVCHD format

- Video signals for the AVCHD that can be played back with this unit are 1920×1080/50i, 1920×1080/25p and 1440×1080/50i.
- This unit may degrade or not play back motion pictures recorded or created on other products, and other products may degrade or not play back motion pictures recorded on this unit, even if the products support AVCHD.

iFrame format

- Video signal for the iFrame that can be played back with this unit is 960×540/25p.
- Motion pictures recorded in AVCHD and iFrame are not compatible with each other.
- This unit may degrade or not play back motion pictures recorded or created on other products, and other products may degrade or not play back motion pictures recorded on this unit, even if the products support iFrame.

MP4 format

- Only the MP4 (640×360/25p) created on this unit can be played back.
- The other products may degrade or not play back motion pictures created on this unit, even if the products support MP4.

Still picture compatibility

- This unit is compliant with the unified standard DCF (Design rule for Camera File system) established by JEITA (Japan Electronics and Information Technology Industries Association).
- The file formats of still pictures supported by this unit are MPO and JPEG. (Not all MPO and JPEG formatted files will be played back.)
- This unit may degrade or not play back still pictures recorded or created on other products and other products may degrade or not play back still pictures recorded on this unit.

Using the menu screen

- Touch ◀ (left side)/ ▶ (right side) of  on the Touch Menu to display  . (→ 16)

1 Touch .



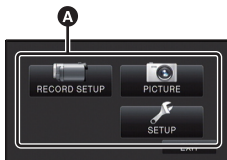

2 Touch the top menu .

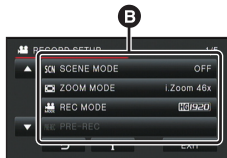

3 Touch the submenu .



- Next (previous) page is displayed by touching  /  .

4 Touch the desired item to enter the setting.



5 Touch [EXIT] to exit the menu setting.

■ About guide display

After touching  , touching the submenus and items will cause function descriptions and settings confirmation messages to appear.

- After the messages have been displayed, the guide display is cancelled.

Using the Setup Menu

- The items displayed differ depending on the position or settings of the mode switch. Select the menu.

[MENU] : [SETUP] → desired setting

[DISPLAY] [5 SECONDS]/[ON]

Set the display method for the screen information display.

[5 SECONDS]: Information is displayed on the screen for 5 seconds after starting the recording mode, starting to playback, or touching the screen.

[ON]: Constantly displayed.

[CLOCK SET]

Please refer to page 17.

[SET WORLD TIME]

It is possible to display and record the time at the travel destination by selecting your home region and the travel destination.

1 Touch [SET WORLD TIME].

- If the clock is not set, adjust the clock to the current time. (→ 17)
- When the [HOME] (your home region) is not set, the message appears. Touch [ENTER] and proceed to Step 3.

2 (Only when setting your home region)

Touch [HOME].

- Touch [ENTER].

3 (Only when setting your home region)

Touch ◀/▶ to select your home region and touch [ENTER].

- Touch [SUMMER TIME SET] to set daylight saving time. ⚙️ appears and the summer time setting is turned on; the time difference from GMT is set forward by one hour. Touch [SUMMER TIME SET] again to return to the normal time setting.





4 (Only when setting the region of your travel destination)

Touch [DESTINATION].

- Touch [ENTER].



- A** The current time
- B** The time difference from GMT (Greenwich Mean Time)

- When the home region is set for the first time, the screen for selecting home/travel destination appears after setting the home region successively. If the home region has already been set once, execute the menu operation for Step 1.
- 5 (Only when setting the region of your travel destination)
- Touch  /  to select your travel destination and touch [ENTER].
- Touch [SUMMER TIME SET] to set daylight saving time.  appears and the summer time setting is turned on. The travel destination time and time difference from the home region time are set forward by one hour. Touch [SUMMER TIME SET] again to return to the normal time setting.
 - Close the setting by touching [EXIT].  appears and the time of the travel destination is indicated.



- C The local time at the selected travel destination
- D The time difference between the travel destination and the home region

To return the display to the home setting

Set the home region using Step 1 to 3, and close the setting by touching [EXIT].

- If you cannot find your travel destination in the area shown on the screen, set it by using the time difference from your home region.

[DATE/TIME]

[DATE]/[D/T]/[OFF]

It is possible to change the date and time display mode.



[DATE FORMAT]

[Y/M/D]/[M/D/Y]/[D/M/Y]

It is possible to change the date format.

[ZOOM/REC DISPLAY]

[ON]/[OFF]

You can set the display method of the zoom button icons ( / ) and recording button icon ().

[ON]: Constantly displayed.

[OFF]: Icons will disappear after approx. 5 seconds without any touch operation.

[O.I.S. LOCK DISPLAY] [ON]/[OFF]

Set the display method for the O.I.S. lock icon ()

[ON]: Constantly displayed.

[OFF]: Icons will disappear after approx. 5 seconds without any touch operation.

[EXT. DISPLAY] [SIMPLE]/[DETAIL]/[OFF]

Please refer to page 99.

[ECONOMY (BATT)] [ON]/[OFF]

When about 5 minutes have passed without any operation, this unit automatically turns off to save battery life.

- This unit will not automatically turn off even if [ECONOMY (BATT)] is set to [ON] in following cases:
 - Using the AC adaptor*
 - Using the USB cable for PC, etc.
 - PRE-REC is used
 - During playback of the slide show



* When [ECONOMY (AC)] is activated, this unit automatically turns off.

[ECONOMY (AC)] [ON]/[OFF]

When about 30 minutes have passed without any operation while connecting AC adaptor with this unit, this unit automatically turns off.

- This unit will not automatically turn off even if [ECONOMY (AC)] is set to [ON] in following cases:
 - Using the USB cable for PC, etc.
 - PRE-REC is used
 - During playback of the slide show

[QUICK POWER ON] [ON]/[OFF]

The unit is put into recording pause approx. 1 second when the unit is turned on with the mode set to  or .

- Depending on the recording conditions, start time may be longer than 1 second.
- In the quick power on mode, the zoom magnification becomes approx. 1×.

This unit is put into recording pause approx. 0.6 seconds after the LCD monitor is reopened.

- **When in Quick Start Standby Mode about 70% of the power used in recording pause mode is being consumed, so the recording time will be reduced.**

- **[HC-V700]**

Quick Start will not work if there is no SD card inserted.

- **[HC-V700M]**

Quick Start will not work if the [SD CARD] is selected in the [MEDIA SELECT], even if there is no SD card inserted.

- **Change the mode to  or .**

1 Set [QUICK START] to [ON].

2 Close the LCD monitor.

The status indicator **A** flashes green and the unit goes into Quick Start standby mode.

- The lens cover does not close.

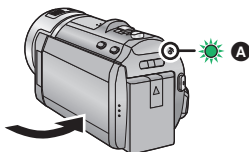

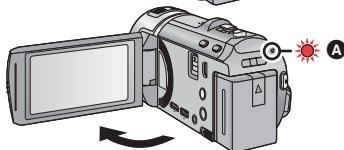

3 Open the LCD monitor.

The status indicator **A** lights red and the unit is put into recording pause.



- Quick Start standby mode is cancelled if
 - about 5 minutes elapsed
 - mode is set to 
- Depending on the recording conditions and menu settings, time for Quick Start may be longer than 0.6 seconds.
- It may take some time for Automatic White Balance to adjust.
- In the Quick Start Mode, the zoom magnification becomes approx. 1×.
- When it has gone into Quick Start Standby Mode automatically with the [ECONOMY (BATT)] (→ 33)/[ECONOMY (AC)] (→ 33), close the LCD monitor once and open it again.
- Turn the unit off using the power button.

Touch screen operation, starting and stopping of recording and unit on/off can be confirmed with this sound.

 (Volume low) /  (Volume high)







2 Beeps for 4 times

When an error occurs. Check the sentence displayed on the screen. (→ 140)

[SELECT OPERATION ICONS]

You can change the operation icons to display in the Touch Menu.

Register 3 favourite operation icons.

- The default settings are,  (Fade),  (PRE-REC) and  (Video Light) for Motion Picture Recording Mode, and  (Built-in flash),  (Self-timer) and  (Backlight Compensation) for Still Picture Recording Mode.

1 Touch [SELECT OPERATION ICONS].

2 Touch the operation icon you would like to change to cancel the setting.

3 Touch the operation icon to be set.

- Name of the function is displayed by touching and holding on the operation icon.
- To cancel, touch the operation icon again.

4 Touch [ENTER].





- For details about the function of each operation icon, refer to page 47.

[POWER LCD]

 /  /  /  / 

This makes it easier to view the LCD monitor in bright places including outdoors.

- These settings will not affect the images actually recorded.

 (Makes even brighter) /  (Makes brighter) /  (Normal) /  (Makes less bright) /  (Automatic adjustment)

- * It is not displayed in the Manual Mode or in the Playback Mode.

- When the AC adaptor is in use, the LCD monitor is set to  automatically.
- Recordable time with the battery is shortened when the LCD is made brighter.

[LCD SET]

It adjusts brightness and colour density on the LCD monitor.

- These settings will not affect the images actually recorded.

1 Touch [LCD SET].

2 Touch the desired setting item.

[BRIGHTNESS]: Brightness of the LCD monitor

[COLOUR]: Colour level of the LCD monitor

3 Touch / to adjust settings.

4 Touch [ENTER].

- Touch [EXIT] to exit the menu screen.

[AV MULTI]**[COMPONENT]/[AV OUT]**

Please refer to page 100.

[COMPONENT OUT]**[1080i]/[576i]**

Please refer to page 100.

[HDMI RESOLUTION]**[AUTO]/[1080p]/[1080i]/[576p]**

Please refer to page 100.

[VIERA Link]**[ON]/[OFF]**

Please refer to page 101.

[TV ASPECT]**[16:9]/[4:3]**

Please refer to page 99.

[3D PLAYBACK]**[AUTO]/[2D]**

Please refer to page 103.

[INITIAL SET]

Set to [YES] for changing the menu settings back to the default condition.

• Settings for [MEDIA SELECT]^{*}, [CLOCK SET] and [LANGUAGE] will not be changed.

* For users who have [\[HC-V700\]](#), this menu is not displayed.

[Auto Cursor Position]**[ON]/[OFF]**

The entered character is confirmed in approx. 1 second at the time of character input, and the cursor is moved to right.

It makes the input easy without moving the cursor when characters on the same key are to be entered again.

- Character input screen is displayed in following conditions:
 - When registering [FACE RECOG.] (→ 57)
 - When setting [TITLE SETUP] for the Highlight Playback (→ 85)

[NUMBER RESET]

Set the file number of the iFrame and still picture recorded next to 0001.

- Folder number is updated and file number will start from 0001. (→ 133)
- To reset the folder number, format the SD card and built-in memory, and then perform [NUMBER RESET].
- Please be aware that if a medium is formatted, then all the data recorded on the medium will be erased and cannot be restored. Back up important data on a PC, DVD disc etc. (→ 109, 122)

[FORMAT CARD]

Please be aware that if a medium is formatted, then all the data recorded on the medium will be erased and cannot be restored. Back up important data on a PC, DVD disc etc. (→ 109, 122)

- When formatting is complete, touch [EXIT] to exit the message screen.
 - Perform a physical formatting of the SD card when the SD card is to be disposed/ transferred. (→ 152)
-
- Do not turn this unit off or remove the SD card, while formatting. Do not expose the unit to vibrations or shock.

Use this unit to format media.

Do not format an SD card using any other equipment such as a PC. The card may not be used on this unit.

[FORMAT MEDIA]

Please be aware that if a medium is formatted, then all the data recorded on the medium will be erased and cannot be restored. Back up important data on a PC, DVD disc etc. (→ 109, 122)

1 Touch [FORMAT MEDIA].

2 Touch [SD CARD] or [Built-inMemory].

- When formatting is complete, touch [EXIT] to exit the message screen.
- Perform a physical formatting of the SD card when the SD card is to be disposed/ transferred. (→ 152)
- Perform a physical formatting of the built-in memory when this unit is to be disposed/ transferred. (→ 149)

-
- Do not turn this unit off or remove the SD card, while formatting. Do not expose the unit to vibrations or shock.

Use this unit to format media.

Formatting built-in memory is only available with this unit.

Do not format an SD card using any other equipment such as a PC. The card may not be used on this unit.

[CARD STATUS]

The used space and remaining recordable time of the SD card can be checked.

- When the mode switch is set to  , remaining recordable time for the selected recording mode is displayed.
 - Touch [EXIT] to close the indication.
-

- The SD card requires some space to store information and manage system files, so the actual usable space is slightly less than the indicated value. The usable space is generally calculated as 1 GB=1,000,000,000 bytes. The capacities of this unit, PCs and software are expressed as 1 GB=1,024×1,024×1,024=1,073,741,824 bytes. Therefore, the indicated value of the capacity appears to be smaller.

[MEDIA STATUS]

The used space and remaining recordable time of the SD card and built-in memory can be checked.



- Touching [CHANGE MEDIA] switches the unit between the display for the SD card and the display for the built-in memory.
 - When the mode switch is set to  , remaining recordable time for the selected recording mode is displayed.
 - Touch [EXIT] to close the indication.
-

- The SD card or built-in memory requires some space to store information and manage system files, so the actual usable space is slightly less than the indicated value. The usable SD card/built-in memory space is generally calculated as 1 GB=1,000,000,000 bytes. The capacities of this unit, PCs and software are expressed as 1 GB=1,024×1,024×1,024=1,073,741,824 bytes. Therefore, the indicated value of the capacity appears to be smaller.

[DEMO MODE]

[ON]/[OFF]

This item is used to start the unit demonstration.

(Only when the mode is at the  or  position)

If [DEMO MODE] is switched to [ON] and you touch [EXIT] when there is no SD card inserted and while this unit is connected to the AC adaptor, the demonstration automatically starts.

If any operation takes place, the demonstration is cancelled. However if no operations take place for approx. 10 minutes, the demonstration automatically starts again. To stop the demonstration, set [DEMO MODE] to [OFF] or insert an SD card.

[O.I.S. DEMO]

This item is used to start the Optical Image Stabilizer demo.

(Only when the mode is at the  position)

Touch [O.I.S. DEMO], the demonstration automatically starts.

When you touch [EXIT], the demonstration will be cancelled.

[LANGUAGE]

You can select the language on the screen display and the menu screen.

Using the zoom

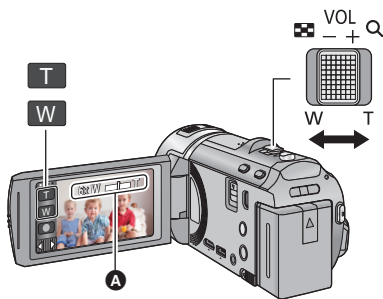

Zoom lever/Zoom button icons

T side:

Close-up recording (zoom in)

W side:

Wide-angle recording (zoom out)

A Zoom bar

- Maximum zoom ratio for recording motion pictures can be set with [ZOOM MODE]. (→ 55)
- You can also perform zoom operation by simply touching the LCD monitor. (Touch Zoom: → 44)

■ About the zoom bar

The zoom bar is displayed during the zoom operation.

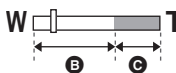

B Optical Zoom

C Motion Picture Recording Mode: i.Zoom/Digital zoom (Blue)

Still Picture Recording Mode: Extra Optical Zoom (Blue)

■ About the zoom speed

The zoom speed will be faster in the order of zoom lever, zoom button icons, and then touch zoom.

- The zoom speed varies depending on the range over which the zoom lever is moved.
- The zoom operation using the zoom button icons or touch zoom will be performed at a constant speed respectively.

Zoom ratio during the Still Picture Recording Mode



The zoom ratio can be expanded up to 50× without degrading the picture quality for the Still Picture Recording Mode. (Extra Optical Zoom)

- Extra optical zoom ratio varies depending on the setting of [PICTURE SIZE] and [ASPECT RATIO]. (→ 65, 66)
-

- If you take your finger off the zoom lever during zoom operation, the operation sound may be recorded. When returning the zoom lever to the original position, move it quietly.
- When the zoom magnification is at its maximum, the subjects are focused at about 1.5 m or more.
- When the zoom magnification is 1×, this unit can focus on a subject approx. 3 cm away from the lens.

Image Stabilizer Function

Use the image stabilizer to reduce the effects of shake during recording.

This unit is equipped with Hybrid Optical Image Stabilizer.

Hybrid Optical Image Stabilizer is a hybrid of optical and electrical image stabilizer.

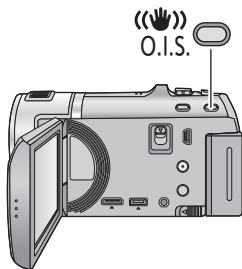



Optical image stabilizer button

Press the button to turn optical image stabilizer on/off.



(Motion Picture Recording Mode)

 /  →  (setting cancelled)

- When [HYBRID O.I.S.] is [ON],  is displayed. When [OFF],  is displayed.
- When recording with a tripod in Motion Picture Recording Mode, we recommend that you set the image stabilizer off.

(Still Picture Recording Mode)

₁ / ₂ →  (setting cancelled)

- When [O.I.S.] is [MODE1], ₁ is displayed. When [O.I.S.] is [MODE2], ₂ is displayed.

■ Changing Image Stabilizer Mode

(Motion Picture Recording Mode)

MENU : [RECORD SETUP] → [HYBRID O.I.S.] → [ON] or [OFF]

When set to [ON], you can further improve image stabilization for recording while walking, or holding the unit and recording a distant subject with zoom.

- This function's default setting is [ON].

(Still Picture Recording Mode)

MENU : [RECORD SETUP] → [O.I.S.] → [MODE1] or [MODE2]

[MODE1]: The function works all the time.

[MODE2]: The function works when the  button is pressed. We recommend using this mode when you are recording yourself or recording with a tripod in Still Picture Recording Mode.

- Please refer to page 46 for details about the Optical Image Stabilizer Lock.



1080/50p recording

This is a recording mode that can record in 1080/50p (1920×1080/50 progressive), which is the highest picture quality for this unit.

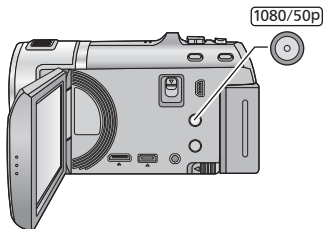

1080/50p button

To set to 1080/50p recording mode, press and hold the button until **1080/50p** is displayed.

- To return to normal recording mode, press and hold the button until **1080/50p** disappears.

It is also possible to set from the menu.

MENU : [RECORD SETUP] → [REC MODE] → [1080/50p]

- Please refer to page 155 about approximate recordable time.

Recording with the Touch Function

You can record using convenient functions just by the easy operation of touching the screen.

1 Touch ◀ (left side)/ ▶ (right side) of  on the Touch Menu to display Touch Function icons. (→ 16)







2 Touch the Touch Function icon.

(e.g. AF/AE tracking)

- To cancel, touch the Touch Function icon again. (Optical Image Stabilizer Lock is cancelled by releasing the finger touching .)



Touch function icons

	Touch Zoom
	AF/AE tracking
	Optical Image Stabilizer Lock* ¹
	Touch Shutter* ²

*¹ In Motion Picture Recording Mode only

*² In Still Picture Recording Mode only



- An icon is displayed in the **A** position when the Touch Function icon is set.



Touch Zoom



Zoom operation can be performed by touching on the touch zoom bar.

- Touch zoom function is useful for making fine adjustments to the zoom magnification.

1 Touch .

- Touch zoom bar appears.

2 Touch and hold the touch zoom bar.

- It will zoom to the touched position.
- It will zoom in when T side is touched, and zoom out when W side is touched.
- It is also possible to perform zoom operation by touching and sliding the touch zoom bar toward the T side or the W side.



- B** Touch zoom bar
- C** Zoom magnification position

- Please refer to page 40 for details about the zoom speed.





It is possible to set the focus and exposure to the subject specified on the touch screen.

The focus and exposure will keep following the subject automatically even if it moves. (Dynamic tracking)

1 Touch

- When [FACE RECOG.] (→ 57) is [ON] and a registered face is detected, the target is automatically locked.

2 Touch the object and lock the target.

- When you touch the head of the object, the target frame on the head gets locked and tracking starts.
- Touch the object to be changed again when you want to change the target.
- When the Intelligent Auto Mode is selected, the setting becomes  (Normal) and touched object is tracked. Selection becomes  (Portrait) when target frame is locked on a face. (It may turn to  (Normal) even if the target is locked on the face when a spotlight is shining or with a dark scene.)



A Target frame

3 Start recording.

■ About target frame

- When target lock fails, the target frame blinks in red and then disappears. Touch a characteristic part (colour etc.) on the object to lock onto it again.
- When the  button is pressed halfway in Still Picture Recording Mode, the focus is set to the object that is locked. The target frame turns green when it focuses, and the target cannot be changed.

-
- This function cannot be used in Manual Mode. When Manual Mode is set in Still Picture Recording Mode, it can only be used with some settings in Scene Mode.
 - It may track different objects or may not lock the target depending on the recording conditions such as the following:
 - When the object is too large or too small
 - When colour of the object is similar to the background
 - When the scene is dark
 - When the target is locked in Still Picture Recording Mode, the screen may become dark or the AF assist lamp may be performed. (→ 68)
 - AF/AE tracking will be cancelled in the following cases.
 - When the mode is changed
 - When the unit is turned off
 - When the Scene Mode is set
 - Switch to Intelligent Auto Mode/Manual Mode
 - Switch to recording of yourself





Optical Image Stabilizer Lock



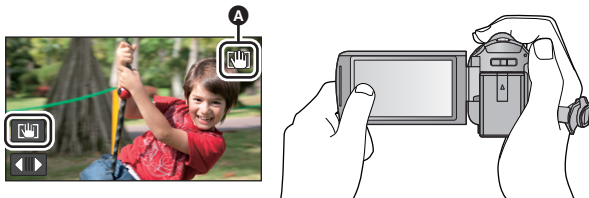

In Motion Picture Recording Mode, you can further improve optical image stabilization by touching and holding . With this function, you can further reduce the effects of the shake that tends to occur when using zoom.



- 1 Press the **Optical Image Stabilizer** button to turn the image stabilizer on.
- 2 Touch and hold .

- Icon is displayed in **A** while you are touching and holding .
- Optical Image Stabilizer Lock is released when you remove your finger from the icon.

■ To make the display of disappear

Display of  will not disappear even when no operation is performed for specific time with the default setting. To make the display of  disappear, change the setting of the [O.I.S. LOCK DISPLAY].

[MENU] : [SETUP] → [O.I.S. LOCK DISPLAY] → desired setting

[ON]: Constantly display.

[OFF]: The icon will disappear after approx. 5 seconds without any touch operation.

- Stabilization may not be possible under strong shaking conditions.
- To record while moving the unit quickly, release Optical Image Stabilizer Lock.



Touch Shutter



It is possible to focus and record a still picture of a subject that is touched.

- 1 Touch .
 - 2 Touch the subject.
- Focus area is displayed at the touched position, and a still picture is recorded.



- Depending on the recording conditions or recognition of the touched position, it may not be possible to record the intended picture.
- This will not operate for recording yourself.

Recording functions of operation icons

Select the operation icons to add different effects to the images to be recorded.

1 Touch ◀ (left side)/▶ (right side) of  on the Touch Menu to display the operation icons. (→ 16)







2 Touch an operation icon.







(e.g. PRE-REC)



- Select the operation icon again to cancel the function. Refer to the respective pages for cancelling the following functions.
 - Smile Shot (→ 49)
 - Built-in flash (→ 50)
 - Self-timer (→ 51)
 - Guidelines (→ 52)
 - Video light (→ 53)
- The icon is displayed in **A** when the operation icon is set. (PRE-REC or Self-timer icon is displayed in **B**.)

Operation icons

	Fade ^{*1}
	Intelligent Contrast Control ^{*1}
	PRE-REC ^{*1}
	Smile Shot ^{*1}
	Built-in flash ^{*2}
	Red-eye Reduction ^{*2}
	Self-timer ^{*2}

	Intelligent Exposure ^{*2}
	Backlight Compensation
	Tele Macro
	Guidelines
	Colour Night View ^{*1}
	Video light

*1 Not displayed in Still Picture Recording Mode.

*2 Not displayed in Motion Picture Recording Mode.

- The operation icons that are displayed in the Touch Menu can be changed. ([SELECT OPERATION ICONS] → 35)
- If you turn off the unit or change the mode to  , PRE-REC, Backlight compensation, Colour Night View, Self-timer and Tele Macro functions are cancelled.
- If you turn off the unit, the Fade function is cancelled.
- It is possible to set from the menu.

Fade

When you start recording, the image/audio gradually appears. (Fade in)

When you pause recording, the image/audio gradually disappears. (Fade out)

- The Fade setting is cancelled when the recording stops.

■ To select the colour for fade in/out

 : [RECORD SETUP] → [FADE COLOUR] → [WHITE] or [BLACK]

(Fade in)



(Fade out)



-
- The thumbnails of scenes recorded using fade in become black (or white).

Intelligent Contrast Control

This brightens parts that are in shadow and difficult to see and suppresses white saturation in bright parts at the same time. Both bright and dark parts can be recorded clearly.

-
- If there are extremely dark or bright parts or the brightness is insufficient, the effect may not be clear.

PRE-REC

This prevents you from missing a shot.

This allows recording of the pictures and sound to start approximately 3 seconds before the recording start/stop button is pressed.

-  appears on the screen.

- Aim the unit at the subject beforehand.
- There is no beep sound.

- PRE-REC is cancelled in the following cases.
 - If you change the mode
 - **HC-V700**
 - If you remove the SD card
 - **HC-V700M**
 - If you remove the SD card while [MEDIA SELECT] is set to [VIDEO/SD CARD]
 - If you touch **MENU**
 - If you press the 1080/50p button
 - If you turn the unit off
 - If you start recording
 - After 3 hours have passed
- After setting PRE-REC, if recording starts in less than 3 seconds, motion pictures taken 3 seconds before pressing the recording start/stop button cannot be recorded.
- Images displayed on the thumbnail in Playback Mode will differ from the motion pictures displayed at the start of playback.



Smile Shot



When a smiling face is detected during motion picture recording, the unit automatically records a still picture.

The icon changes each time it is touched.

([ON]) → ([FACE RECOG.]) → [OFF]



The unit records a still picture on detecting a smiling face.





Still pictures are only recorded when the face of a person registered using Face Recognition (→ 57) is detected.

[OFF]:

Cancel the setting.

- During Smile Shot recording, the face detected as a smiling face is surrounded by a green frame and / are red.
- Smile Shot recording will not work in the following cases. (/ will flash)
 - **HC-V700**
 - When there is no SD card inserted
 - **HC-V700M**
 - When it is set to [PICTURE/SD CARD] in [MEDIA SELECT], and there is no SD card inserted
 - When it is set to Manual Focus
 - When [FACE RECOG.] is set to [OFF], or no one is registered (In ([FACE RECOG.]) only)

- Depending on the recording conditions (type of smile, camera shake, etc.), the face of the subject may not be detected correctly.
- The number of recording pixels are $\boxed{5.8\text{M}}$ (3200×1800) or $\boxed{2.1\text{M}}$ (1920×1080). (→ 65)
- When still pictures that have been recorded using the Smile Shot are displayed as thumbnails, the  appears.
- When the AF/AE tracking function is target locking a face of the subject, still pictures are only recorded if a smiling face is detected on the locked subject. When the Smile Shot function is set to  ([FACE RECOG.]), it will record only if a face of a subject registered with [FACE RECOG.] is locked as a target.



Built-in flash



When the  button is pressed, the flash is activated and the picture will be recorded. Use the Built-in flash in order to record still pictures in dark places.

Each time the icon is selected, the indication changes by one setting in the following order:

 ([ON]) →  A ([AUTO]) →  ([OFF])

- The unit automatically determines if the flash is necessary even when it has been set to  by detecting the ambient brightness. (If it determines that the flash is necessary, the  indication lights up in red.)



■ To adjust the brightness of the flash

 : [PICTURE] → [FLASH LEVEL] → desired setting

 +: Much brighter

 ± 0: Normal

 -: Less bright

- If the  indication etc. flashes when the  button is pressed halfway, the flash is not activated.
- Do not use this unit with Filter kit (optional) or conversion lens (optional) attached.
- The available range of the flash is approx. 1 m to 2.5 m in dark places.
- Using the flash fixes a shutter speed to 1/500 or slower.

Red-eye Reduction



Reduces the phenomena where human eyes become red from flashes.

- The flash is activated 2 times.
- The red-eye phenomenon tends to appear in certain recording conditions and more with some people than with others.
- When faces are detected in the Intelligent Auto Mode, the Red-eye Reduction is set to on.



Self-timer



This is for recording still pictures using the timer.

Each time the icon is selected, the indication changes by one setting in the following order:
☺10 (Records after 10 seconds) → ☺2 (Records after 2 seconds) → setting cancelled

- When you press the button, ☺10 or ☺2 flashes for the set period before a still picture is recorded. After recording, the Self-timer is cancelled.
- In Auto Focus Mode, if the button is pressed halfway once and then fully, the lens focuses on the subject when the button is pressed halfway. If the button is pressed fully all at once, the lens focuses on the subject just before recording.

To stop the timer midway through

Touch [CANCEL].

-
- Setting the Self-timer to ☺2 is a good way to prevent image shake when the button is pressed while using a tripod etc.



Intelligent Exposure



This brightens dark areas so the image can be recorded clearly.

-
- If there are extremely dark parts or the brightness is insufficient, the effect may not be clear.



Backlight Compensation



This makes the image brighter to prevent darkening of a backlit subject.



Tele Macro



A more impressive image can be obtained by focusing on the object only in close-up and shading off the background.

- The unit can focus on the subject at a distance of approx. 60 cm.
- When the Tele Macro is set with the zoom magnification less than 26× in Motion Picture Recording Mode, it will automatically be set to 26×.
- When the aspect ratio is [4:3], [3:2] during the still picture recording mode and tele macro is set with the zoom magnification less than 21×, the zoom magnification will automatically be set to 21×. When the aspect ratio is [16:9], the zoom magnification will be 26×.

- The Tele Macro function is cancelled automatically when the zoom magnification becomes lower than 26× in Motion Picture Recording Mode.
- Tele Macro function is cancelled automatically when the zoom magnification becomes lower than the size below in Still Picture Recording Mode:
 - Less than 21× (when the aspect ratio is [4:3] or [3:2])
 - Less than 26× (when the aspect ratio is [16:9])



Guidelines



You can check if the image is level while recording or playing back motion pictures and still pictures. The function can also be used to estimate the balance of the composition.

It will switch every time the icon is touched.

→ → → Setting cancelled

- The guidelines do not appear on the images actually recorded.

■ Displaying Guidelines at playback

- Change the mode to and touch the play mode select icon. Then, select the AVCHD scene, or set to [iFrame] or [MP4]. (→ 27)

: [VIDEO SETUP] → [GUIDE LINES] → desired setting

- To cancel the Guideline function during playback, set to [OFF].
- It cannot be set while in Still Picture Playback Mode.



Colour Night View



This function allows you to record colour images in very low light situations.
(Minimum required illumination: approx. 1 lx)

- Recorded scene is seen as if frames were missed.
- If set in a bright place, the screen may become washed out for a while.
- Bright dots that are usually invisible may be seen, but this is not a malfunction.
- Using a tripod is recommended.
- In darker areas, Auto Focus may focus a bit slower. This is normal.



Video light



It is possible to record with illumination even in dark places.

Each time the icon is selected, the indication changes by one setting in the following order.

([ON]) → ([AUTO]) → ([OFF])

- : Always on.
- : Turns on/off automatically according to brightness of the surroundings.
- : Cancel the setting.

- When set to ([AUTO]), the video light turns on in Low Light Mode in Intelligent Auto Mode.
- When the video light is in use, the recordable time when using the battery is shortened.
- The (approximate) available range of the video light is approximately up to 1.2 m.
- Using the Colour night view function at the same time will make conditions even brighter.
- When you take a picture in a dark place in still picture recording mode with [AF ASSIST LAMP] set to [AUTO] (→ 68), and the video light set to ([AUTO]) or ([OFF]), the lamp is turned on to make it easier to focus.
- Set the video light to ([OFF]) at places where using a light is prohibited.













Recording functions of menus

[SCENE MODE]



When you record images in different situations, this mode automatically sets optimum shutter speeds and apertures.

[MENU] : [RECORD SETUP] → [SCENE MODE] → desired setting

[OFF]:	Cancel the setting
 Sports:	To make fast moving scenes less shaky with slow playback and pause of playback
 Portrait:	To make people stand out against the background
 Soft skin:	To makes skin colours appear softer for a more attractive appearance
 Spotlight:	Improved quality when subject is brightly illuminated.
 Snow:	Improved image quality when shooting in snowy locations.
 Beach:	To make blue in the sea or sky vibrant
 Sunset:	To make red in the sunrise or sunset vibrant
 Scenery:	For spatial scenery
 Fireworks:	To capture the fireworks in the night sky beautifully
 Night scenery:	To capture the evening or night scenery beautifully
 Low light:	For dark scenes, such as at dusk (In Motion Picture Recording Mode only)
 Night portrait:	To capture a person and the background brightly (In Still Picture Recording Mode only)

- **(Sports/Portrait/Soft skin/Spotlight/Snow/Beach/Sunset/Scenery)**
 - The shutter speed is 1/6 or more in Still Picture Recording Mode.
- **(Sunset/Low light)**
 - The shutter speed is 1/25 or more in Motion Picture Recording Mode.
- **(Sunset/Scenery/Fireworks/Night scenery)**
 - Image may get blurry when close object is recorded.

- **(Sports)**
 - During normal playback, the image movement may not look smooth.
 - Colour and screen brightness may change under indoor lighting.
 - If the brightness is insufficient, the Sports Mode does not function. The  display flashes.
- **(Portrait)**
 - Colour and screen brightness may change under indoor lighting.
- **(Soft skin)**
 - If the background or anything else in the scene has colours similar to the skin colour, they will also be smoothed.
 - If the brightness is insufficient, the effect may not be clear.
 - If you record a person in the distance, the face may not be recorded clearly. In this case, cancel Soft Skin Mode or zoom in on the face (close-up) to record.
- **(Fireworks)**
 - The shutter speed is 1/25.
 - Image may get washed out when recorded in bright surrounding.
- **(Night scenery/Night portrait)**
 - The shutter speed is 1/2 or more in Still Picture Recording Mode.
 - Using a tripod is recommended.
- **(Night portrait)**
 - The flash is set to [ON].

[ZOOM MODE]

Set the maximum zoom ratio for the Motion Picture Recording Mode.

 : [RECORD SETUP] → [ZOOM MODE] → **desired setting**

[i.Zoom OFF]:	Up to 26×
[i.Zoom 46×]:	This zoom function allows you to maintain high-definition picture quality. (Up to 46×)
[D.Zoom 60×]:	Digital zoom (Up to 60×)
[D.Zoom 1500×]:	Digital zoom (Up to 1500×)

- The larger the digital zoom magnification, the more the image quality is degraded.

- This function cannot be used in Still Picture Recording Mode.

[REC MODE]



Switch the picture quality and recording format of the motion pictures to record.

MENU : [RECORD SETUP] → [REC MODE] → desired setting

[HA]/[HG]/[HX]/[HE]*1: Set the recording mode to 1080/50i.

[1080/50p]*2: Set the recording mode to 1080/50p.

[iFrame]*3: Set the recording mode to iFrame.

*1 Recording will have higher quality in the order of [HA], [HG], [HX] and [HE].

*2 It can record with highest quality image in this unit.

*3 [iFrame] is a format suitable for Mac (iMovie'11). It is recommended for when using a Mac.

● Recordable time using the battery (→ 11)

- This function's default setting is [HG] mode.
- Please refer to page 155 about approximate recordable time.
- When the unit is moved a lot or moved quickly, or when a fast-moving subject is recorded (particularly when recording in [HE] mode), mosaic-type noise may appear at playback.

HC-V700M

[RELAY REC]



It is possible to continuously record motion picture to an SD card when there is no space available in the built-in memory. (It allows you to record only to SD card from built-in memory.)

- Set [MEDIA SELECT] to [Built-inMemory].
- Set [REC MODE] to [HA], [HG], [HX], [HE] or [1080/50p].
- Insert an SD card.

MENU : [RECORD SETUP] → [RELAY REC] → [ON]

- ⇨ is displayed on the screen. ⇨ will disappear when space in the built-in memory is gone and the recording to the SD card starts.
- Relay Recording can only be performed once.
- **Combine the scenes that were relay-recorded using the [RELAY SCENE COMBINE] into the SD card. (→ 95, 107)**
- Once you have performed [RELAY SCENE COMBINE], you can use the Relay Recording function again. If the [RELAY REC] is set to [ON] without performing the [RELAY SCENE COMBINE], a message is displayed. You will be able to perform Relay Recording by touching [YES], but you will not be able to perform the [RELAY SCENE COMBINE] after that.

- Still pictures are recorded to the SD card after Relay Recording.
-  is displayed on the thumbnail display during the playback of the scene that was relay-recorded on the built-in memory.

[FACE RECOG.]



Face Recognition is a function for finding faces that resemble faces which have already been registered and automatically prioritising focus and exposure for those faces. This function makes it possible to keep the face of your loved ones in focus even when they are at the back or on the end of a line in a group picture.

 : [RECORD SETUP] → [FACE RECOG.] → desired setting

[ON]: The Face Recognition function is available.

[OFF]: Cancel the setting.

[SET]: Face Recognition registration/editing/cancellation

■ Registering a face for Face Recognition

 : [RECORD SETUP] → [FACE RECOG.] → [SET] → [SAVE]

- Up to a maximum of 6 people can be registered.

1 Align the person's face with the guide.

- Take a picture of the person's face from the front, ensuring that their hair does not hide the outline of their face, their eyes or their eyebrows.

2 Touch [REC] or press the button fully.

- Touch [ENTER].
- It may not be possible to register a face depending on the recording conditions. In this case, try recording the face again.

3 Enter the person's name.

- Touch the text entry icon in the centre of the screen and enter the name.
- After entering the name, touch [Enter].

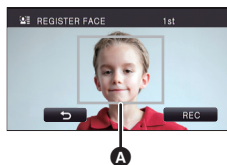

A Guide



B Text entry icon

Entering text

- The characters can be conveniently input without moving the cursor when the [Auto Cursor Position] is set to [ON]. (→ 36)

Icon	Description of operation
[A] etc.	Enters a character.
◀ / ▶	Moves the cursor to left or right.
[A/a]	Switches between [A]/[a] (alphabet) and [&/1] (symbols/numbers).
↵	Enters a space.
[Delete]	Deletes a character. Deletes the previous character if the cursor is in an empty space.
[Enter]	Ends text entry.

- A maximum of 9 characters can be entered.

4 Touch [ENTER] to end registration.

- Touch [EXIT].

■ Changing the information of a registered person

1 Select the menu.

[MENU] : [RECORD SETUP] → [FACE RECOG.] → [SET] → [EDIT]

2 Touch the desired item to enter the setting.

- Up to 3 face shots can be registered. To additionally register or to change/delete the registered face shots, touch  or the face shot.
- If you register several face shots of the same person (up to 3 face shots can be registered), each with a different facial expression or different background, it is more likely that Face Recognition will be successful.

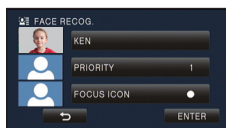

Change name:

Touch the part displaying the registered name, and change the name.

[PRIORITY]:

Focus and exposure will be set in priority according to the registration order setting from the first person. Target will be locked according to the registration order setting from the first person when AF/AE tracking is active.

- To change the registration order, select the person you wish to change.

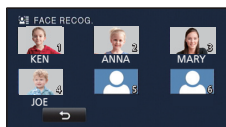

[FOCUS ICON]:

This changes the focus indication (→ 22) icon that appears during still picture recording. (Only displayed when Face Recognition is in use.)

- Touch the icon you wish to have displayed.

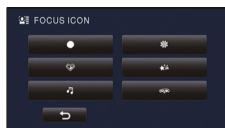

3 Touch [ENTER].

■ Cancelling a registered person

1 Select the menu.

[MENU] : [RECORD SETUP] → [FACE RECOG.] → [SET] → [DELETE] or [DELETE ALL]

- Touching [DELETE ALL] cancels all the registered people.

2 (When [DELETE] is selected)

Touch the person to cancel.

- When touched, the person is selected and  is displayed. To cancel the selected person, touch again.
- Touch [ENTER].

- Since Face Recognition searches for faces that resemble the registered faces, there is no guarantee of positive recognition.
- It may not be possible to correctly recognise a person who has been registered due to differences in facial expression and environment.
- Perform the registration again if recognition becomes unstable in cases such as when facial features change with age.

[NAME DISPLAY]



When a registered person is detected by Face Recognition during recording, the name registered for that person is displayed.

[MENU] : [RECORD SETUP] → [NAME DISPLAY] → desired number

[3]/[2]/[1]/[OFF]

- Displayed name will disappear after a while.
- It is displayed according to the registration order setting from the first person.
- This function is not displayed during recording of yourself or Playback Mode.

[FACE FRAMING]



Detected faces appear with frames.

: [RECORD SETUP] → [FACE FRAMING] → desired setting

[PRIMARY]:

Only the prioritised face framing is displayed.

[ALL]:

All face detection framings are displayed.

[OFF]:

Cancel the setting.



- Up to 15 frames are indicated. Larger faces and faces nearer to the centre of the screen take preference over others. When [FACE RECOG.] is [ON], registered people are given priority.

■ Prioritised face framing

Prioritised face framing is displayed as orange frames. Focus and adjustment of brightness will be performed against the prioritised face framing.

- Prioritised face framing is only displayed with Portrait Mode in the Intelligent Auto Mode.
- The white frame is for face detection only.
- Focus will be set to prioritised face framing when the button is pressed halfway when recording still pictures. Prioritised face framing will turn to green when the focus is set.

[AUTO SLOW SHTR (2D)]



You can record bright pictures even in dark places by slowing the shutter speed.

- **Switch to Manual Mode. (→ 69)**

: [RECORD SETUP] → [AUTO SLOW SHTR (2D)] → [ON]

- The shutter speed is set to 1/25 or more depending on the surrounding brightness.
- This function cannot be used when using the 3D Conversion Lens (optional).
- This function cannot be used in Still Picture Recording Mode.
- When the shutter speed becomes 1/25, the screen may be seen as if frames are missed and afterimages may appear.

[AUTO SLOW SHTR (3D)]



This auto slow shutter function is only used with the 3D Conversion Lens (optional).

- **Switch to Manual Mode. (→ 69)**

 : [RECORD SETUP] → [AUTO SLOW SHTR (3D)] → [ON]

- For details, refer to [AUTO SLOW SHTR (2D)].
- This function's default setting is [ON].
- When a 3D Conversion Lens is used, the recording scene will become darker. We recommend setting this function to [ON].

[AGS]



If the unit continues to be tilted upside down from the normal horizontal position while recording motion pictures, it is automatically put into recording pause.

 : [RECORD SETUP] → [AGS] → [ON]

- The AGS function may activate and cause the unit to pause the recording if you are recording a subject right above or right below you.

[Digital Cinema Colour]



Recording motion pictures with more vivid colours, using x.v.Colour™ technology.

- **Switch to Manual Mode. (→ 69)**
- **Set [REC MODE] to [HA], [HG], [HX], [HE] or [1080/50p]. (→ 56)**

 : [RECORD SETUP] → [Digital Cinema Colour] → [ON]

- For more realistic colours, use an HDMI mini cable (optional) with a TV that supports the x.v.Colour™.
- **When motion pictures recorded while this function is turned [ON] are played back with a TV not compatible with x.v.Colour™, colours may not be reproduced properly.**
- It is recommended to record with the setting set to [OFF] when playing back the video on an equipment other than the ones compatible with the x.v.Colour™.
- x.v.Colour™ is a name for devices that are compatible with the xvYCC format, an international standard for expanded colour in motion pictures, and that follow the rules for signal transmission.

[SHOOTING GUIDE]



Message is displayed when this unit is moved rapidly.

 : [RECORD SETUP] → [SHOOTING GUIDE] → [ON]

When "CAMERA PANNING IS TOO FAST." appears, move the unit slowly while recording.

- Message will not appear while pausing the recording. (Message will appear even if it is pausing the recording if [DEMO MODE] is set to [ON].)

[WIND NOISE CANCELLER]



This will reduce the wind noise coming into the built-in microphones while maintaining the realism.

- **Switch to Manual Mode. (→ 69)**

 : [RECORD SETUP] → [WIND NOISE CANCELLER] → [ON]

- This function's default setting is [ON].
- When switching to Intelligent Auto Mode, [WIND NOISE CANCELLER] is set to [ON], and the setting cannot be changed.
- You may not see the full effect depending on the recording conditions.

[ZOOM MIC]



Directivity of the microphone is interlocked with the zoom operation. Sounds near the front of the unit are recorded more clearly if you zoom in (close-up) and surrounding sounds are recorded more realistically if you zoom out (wide angle).

 : [RECORD SETUP] → [ZOOM MIC] → [ON]



When recording, the input level from the built-in microphones and the external microphone terminal can be adjusted.

1 Select the menu.

MENU : [RECORD SETUP] → [MIC LEVEL] → desired setting

[AUTO]: AGC is activated, and the recording level is adjusted automatically.

[SET+ **AGC]/[SET]:** The desired recording level can be set.

2 (When [SET+ **AGC**]/[SET] is selected)

Touch **◀ / **▶** to adjust.**

- Touch **AGC** to activate/disactivate AGC. When AGC is activated, the icon is surrounded by yellow and the amount of sound distortion can be reduced. When AGC is deactivated, natural recording can be performed.
- Adjust the microphone input level so that the last 2 bars of the gain value are not red. (Otherwise, the sound is distorted.) Select a lower setting for microphone input level.



- A** Left
- B** Right
- C** Microphone input level

3 Touch [ENTER] to set the microphone input level and then touch [EXIT].

- □□□■ ■ ■ ■ ■ (Microphone input level meter) appears on the screen.

- When [ZOOM MIC] is [ON], the volume will be different depending on the zoom rate.
- The microphone input level meter shows the larger of the inputs from the 2 built-in microphones.
- You cannot record with the audio completely muted.

Adjust the quality of the image while recording.

Adjust by outputting to a TV while adjusting the quality of the image.

- **This setting is retained when you change between Motion Picture Recording Mode and Still Picture Recording Mode.**

- **Switch to Manual Mode. (→ 69)**

1 Select the menu.

 : [RECORD SETUP] → [PICTURE ADJUST]

2 Touch the desired setting items.

[SHARPNESS]:	Sharpness of the edge
[COLOUR]:	Depth of the colour of the image
[EXPOSURE]:	Brightness of the image
[WB ADJUST]:	Picture colour balance

3 Touch  /  to adjust settings.

4 Touch [ENTER].

- Touch [EXIT] to complete the settings.







-  appears on the screen.

The higher the number of pixels, the higher the clarity of the picture when printing.

MENU : [PICTURE] → [PICTURE SIZE] → desired setting

- The number of recording pixels that can be set changes depending on selected screen aspect ratio. (→ 66)

Picture size and Maximum zoom ratio



Picture size		Aspect ratio	Extra optical zoom (→ 41)
	2848×2136	4:3	—*
	1760×1320		23×
	640×480		50×
	3024×2016	3:2	—*
	1872×1248		22.9×
	3200×1800	16:9	26×
	1920×1080		28.1×



* Extra optical zoom cannot be used. The maximum zoom magnification is 21×

Picture size in Motion Picture Recording Mode

- Change the mode to  .

MENU : [PICTURE] → [PICTURE SIZE] → desired setting

Picture size		Aspect ratio
	3200×1800	16:9
	1920×1080	

- This function's default settings are  in Still Picture Recording Mode and  in Motion Picture Recording Mode.
- Please refer to page 156 about the number of recordable pictures.
- The recording will become longer depending on the recording pixels.



This allows you to select the aspect ratio of the pictures to suit printing or the playback method.

MENU : **[PICTURE]** → **[ASPECT RATIO]** → **desired setting**

[4:3]: Aspect ratio of 4:3 television

[3:2]: Aspect ratio of conventional film camera or prints (such as L-size print)

[16:9]: Aspect ratio of high-definition television, etc.

- This function's default setting is [4:3].
- When the aspect ratio is set to [4:3] or [3:2], black bands may appear on the left and right of the screen.
- The edges of still pictures recorded on this unit with a [16:9] aspect ratio may be cut at printing. Check the printer or photo studio before printing.



Recording is done continuously at the rate of 50 still pictures per second.
Use this function to record an object with fast movement.

1 Select the menu.

[MENU] : **[PICTURE]** → **[HI-SPEED BURST]** → **[ON]**

[ON]: 180 still pictures are recorded continuously at the rate of 50 per second.
The picture size is **[2.1M]** (1920×1080).

[OFF]: Cancel the setting.

2 Press the button.

- flashes in red during recording.
- First press the button halfway, then press it fully to set the focus and record. It will automatically focus if you press fully once, so it is convenient when recording objects moving back and forth.

3 Touch [Record] or [Delete].

[Record]: Pictures are stored.

[Delete]: All pictures are deleted.

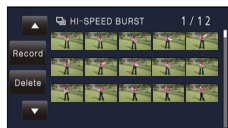

4 (When [Record] is selected in Step 3) Touch [REC ALL] or [SELECT].

[REC ALL]: All pictures are stored.

[SELECT]: Pictures are stored by specifying range.

5 (When [SELECT] is selected in Step 4) Touch the range of pictures that will be stored.

- Previous (Next) page is displayed by touching / .
- * Only select the picture for start point if only 1 picture is to be stored.
- A confirmation message is displayed when [Enter] is touched after selecting the start point and finish point. Touch [YES] to store the pictures.

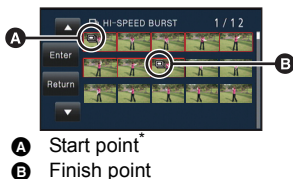

-
- If you turn off the unit or change the mode, this function is cancelled.
 - The maximum number of times you can record on a media is 15.
(In the case of SD cards it is the maximum number of recordable scenes per card.)
 - Colour balance and brightness on the screen may change with some light sources such as fluorescent lamps.
 - Image quality is different from ordinary still picture recording.

[AF ASSIST LAMP]



The video light is turned on to make it easier to focus when you are recording in dark places where it is hard to focus.

- **Switch to Manual Mode.** (→ 69)

: [PICTURE] → [AF ASSIST LAMP] → [AUTO]

- Set the video light to ([AUTO]) or ([OFF]). (→ 53)

-
- When switching to Intelligent Auto Mode, the setting is fixed to [AUTO] and cannot be changed.

[SHTR SOUND]



You can add a shutter sound when recording still pictures.

: [PICTURE] → [SHTR SOUND] → **desired setting**

: Volume low

: Volume high

[OFF]: Cancel the setting.

-
- No shutter sound is emitted in Motion Picture Recording Mode.

Manual recording

- The Manual Focus, White Balance, Shutter Speed, Brightness (Iris and Gain) settings are retained when you change between Motion Picture Recording Mode and Still Picture Recording Mode.

Press the **iA/MANUAL** button to switch to Manual Mode.

- **MNL** appears on the screen.

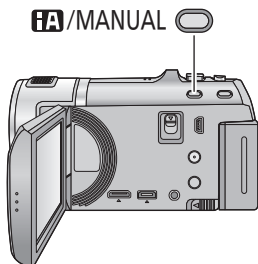

- A** manual icons

FOCUS	Focus (→ 72)
WB	White Balance (→ 70)
SHTR	Manual Shutter Speed (→ 71)
IRIS	Iris Adjustment (→ 71)

White Balance



Automatic White Balance function may not reproduce natural colours depending on the scenes or lighting conditions. If so, you can adjust the White Balance manually.

- Press the **iA/MANUAL** button to switch to Manual Mode. (→ 69)

1 Touch **[WB]**.

2 Touch / to select White Balance Mode.

- Select the optimal mode by confirming the colour on the screen.
- Touch **[WB]** to select the mode.



Icon	Mode/Recording conditions
	Auto White Balance adjustment
	Sunny mode: Outdoors, under a clear sky
	Cloudy mode: Outdoors, under cloudy sky
	Indoor mode 1: Incandescent light, video lights like in the studio, etc.
	Indoor mode 2: Colour fluorescent lamps, sodium lamps in gymnasiums etc.
	Manual adjustment mode: <ul style="list-style-type: none">• Mercury-vapor lamps, sodium lamps, some fluorescent lights• Lights used for wedding receptions at hotels, stage spotlights in theaters• Sunrise, sunset, etc.

- To return to auto setting, set to **AWB** or press the **iA/MANUAL** button again.

■ To set the White Balance manually

1 Select , fill the screen with a white subject.

2 Touch and set the blinking .

- When the screen turns black instantly and the display stops flashing and then lights constantly, the setting is complete.
- If the display continues flashing, the White Balance cannot be set. In this case, use other White Balance modes.



- When the display flashes, the Manual White Balance previously adjusted is stored. Whenever recording conditions change, re-set the White Balance.
- When setting both the White Balance and the iris/gain, set the white balance first.
- **AWB** is not displayed on the screen when **AWB** is being set.

Manual shutter speed/iris adjustment



Shutter Speed:

Adjust it when recording fast-moving subjects.

Iris:

Adjust it when the screen is too bright or too dark.

- Press the **iA/MANUAL** button to switch to Manual Mode. (→ 69)

1 Touch [SHTR] or [IRIS].

2 Touch / to adjust settings.

- Touch [SHTR]/[IRIS] to end the adjustment.

: Shutter speed:

1/50 to 1/8000

- If [AUTO SLOW SHTR (2D)] is set to [ON], the shutter speed will be set between 1/25 and 1/8000.
- The shutter speed closer to 1/8000 is faster.
- The shutter speed will be set between 1/2 and 1/2000 in Still Picture Recording Mode.

: Iris/Gain value:

CLOSE ↔ (F16 to F2.0) ↔ OPEN ↔ (0dB to 18dB)

- Value closer to CLOSE darken the image.
- Value closer to 18dB brighten the image.
- When the iris value is adjusted to brighter than OPEN, it changes to the gain value.
- To return to auto setting, press the **iA/MANUAL** button again.

-
- When setting both the shutter speed and the iris/gain value, set the shutter speed and then set the iris/gain value.

Manual shutter speed adjustment

- When the shutter speed is set lower than 1/12 in the Still Picture Recording Mode, using a tripod is recommended. Also, White Balance cannot be set. The shutter speed will be set to 1/25 when the unit is turned on again or when the Quick Start is performed.
- You may see a band of light around an object that is shining very bright, or highly reflective.
- During normal playback, image movement may not look smooth.
- If you record an extremely bright object or record under indoor lighting, colour and screen brightness may change or a horizontal line may appear on the screen. In this case, record in the Intelligent Auto Mode or set the shutter speed to 1/100 in areas where the power supply frequency is 50 Hz, or 1/125 in areas of 60 Hz.
- Brightness of the image displayed on the LCD monitor may be different from brightness of the image actually recorded during the still picture recording mode. Confirm the image on the playback screen after recording.

Manual iris/gain adjustment

- If the gain value is increased, the noise on the screen increases.
- Depending on the zoom magnification, there are iris values that are not displayed.

Manual Focus adjustment



If auto focusing is difficult due to the conditions, then use Manual Focus.

- Press the **i/MANUAL** button to switch to Manual Mode. (→ 69)

1 (When MF assist function is used)

Select the menu.

MENU : [RECORD SETUP] → [MF ASSIST] → [ON]

- Touch to display the Manual icon.

2 Touch [FOCUS].

3 Touch [MF] to change to Manual Focus.

- MF appears on the screen.

4 Adjust the focus by touching $\text{MF}^+ / \text{MF}^-$.

MF^+ : To focus on a close subject

MF^- : To focus on a faraway subject



The in-focus area is displayed in blue. The normal screen returns approximately 2 seconds after you finish bringing the subject into focus.

A Part displayed in blue

- Touch [FOCUS] to end the adjustment.
- When [MF ASSIST] is [OFF], the blue area is not displayed.
- To restore Auto Focus, touch [AF] in Step 3 or press the **i/MANUAL** button again.

-
- The blue display does not appear on the images actually recorded.

Recording 3D image

With the 3D Conversion Lens (optional) attached, you can record life-like and powerful 3D image. To view 3D image, a television that supports 3D is required.

To attach the 3D Conversion Lens to this unit, a step up ring supplied with the 3D Conversion Lens is required.

3D image





The image is an illustration.

- In the unit, the recordable 3D images are side-by-side format (2-screen structure).
- Since the 3D image is recorded in side-by-side format, the recorded 3D image is not of high definition picture quality.

■ Recording 3D image

For details on how to attach and how to adjust the attachment position of the 3D Conversion Lens, please read the operating instructions for the 3D Conversion Lens.

When using for the first time, be sure to adjust the 3D Conversion Lens attachment position.

- Turn off the unit.
- Change the mode to  or .

1 Attach the step up ring to the 3D Conversion Lens.

- Attach it by sliding the lock lever of the 3D Conversion Lens to the LOCK position.
- Attach the Lens front cap supplied with the 3D Conversion Lens.

2 Attach the 3D Conversion Lens to the unit.

- Tighten the attachment screw of the step up ring by rotating to LOCK.
- Attach the 3D Conversion Lens securely so it will not tilt or move.

3 Turn on the unit.

- Turn on with the unit in a horizontal state.
- The 3D Conversion Lens adjustment mode screen will appear automatically after performing the initial setting.
- If the 3D Conversion Lens adjustment mode screen does not appear automatically, set from the menu.
 ([SETUP] → [3D CONV. LENS SETUP])
- If the unit is turned on with the USB cable still connected, the USB connection will take priority.

4 Adjust the lens attachment part following the instructions on the screen.

5 Touch [EXIT] to end the adjustment.

- When re-attaching the 3D Conversion Lens or after an impact etc., it is recommended that you perform the adjustment again.



6 (When recording motion pictures)

Press the recording start/stop button to start recording. (→ 20)

- Start recording after removing the Lens front cap.

(When recording still pictures)

Press the  button to record still pictures. (→ 22)

-  appears on the screen.
- It is possible to record still pictures while recording motion pictures. (Simultaneous recording)
- The number of recording pixels are  (1920×1080). (→ 65)

To ensure that the 3D image can be safely viewed, pay attention to the following points when recording.

- Where possible, record with the unit in a horizontal state.
- Do not get too close to the subject. (record from a distance of at least 1.2 m.)
- When moving the unit as you record, move it slowly.
- Try to hold the unit as steady as possible when recording while riding in a vehicle or walking.

-
- Use of a tripod is recommended for recording with a stable picture.
 - [ECONOMY (BATT)]/[ECONOMY (AC)] will not work while you adjust the 3D Conversion Lens attachment position.
 - When the 3D Conversion Lens is attached, the auto slow shutter setting is [AUTO SLOW SHTR (3D)]. The default setting of [AUTO SLOW SHTR (3D)] is [ON]. (→ 61)
 - While 3D recording if moving the unit fast, the message is more likely to appear.
 - The LCD monitor on this unit will not display in 3D.
 - If the unit is turned on in the shade, etc., the screen may appear to be blue. In such a case, removing the lens cap will return the screen to normal.

■ Functions that cannot be used during 3D recording

When recording with the 3D Conversion Lens, you cannot use certain functions.

Functions not available during 3D recording

(Button/lever operations)

- Zoom in/out function^{*1}
- Hybrid Optical Image Stabilizer^{*2}
- Intelligent Auto Mode (Night portrait and Macro)
- 1080/50p recording^{*3}
- Manual Focus

(Motion picture recording function)

- iFrame ([REC MODE])
- Smile Shot
- Video light
- Tele Macro
- Face Recognition
- Zoom Microphone

(Setup menu)

- Quick power on
- Quick Start
- Initial set

(Still picture recording function)

- Picture size
- Aspect ratio
- Built-in flash
- Flash level
- Red-eye Reduction
- Video light
- Night portrait in Scene Mode
- AF Assist Lamp

*1 The zoom position is fixed, and the zoom operation is disabled.

*2 The Optical Image Stabilizer (👉) and Optical Image Stabilizer Lock (👉) can be used.

























*3 The 1080/50p recording mode is cancelled, and the video is recorded with 1080/50i picture quality.

Playback Operations

Motion picture playback using operation icon



For details on the basic playback operations, refer to page 27.

Playback operation	Playback display	Operating steps
Fast forward/ rewind playback	During Playback    	<p>Touch  during playback to fast forward. (Touch  to rewind.)</p> <ul style="list-style-type: none"> • The fast forward/rewind speed increases if you touch / again. (The display on the screen changes from  to .) • Normal playback is restored when you touch .
Skip playback (to the start of a scene)		<p>Touch the LCD monitor and slide from right to left (from left to right) during playback.</p>
Slow-motion Playback	During Pause    	<p>With the playback paused, continue touching . ( is for slow rewind playback)</p> <p>Playback is slow while touching.</p> <ul style="list-style-type: none"> • Normal playback is restored when you touch . • When Slow-motion pictures are played back in reverse, they will be shown continuously at approximately 2/3rd the speed of normal playback (intervals of 0.5 seconds). • Slow-motion Playback of the scenes in iFrame or the scenes saved as MP4 will be shown in intervals of 1 second.
Frame-by-frame playback The motion picture is advanced one frame at a time.	   	<p>With the playback paused, touch .</p> <p>(Touch  to advance the frames one at a time in the reverse direction.)</p> <ul style="list-style-type: none"> • Normal playback is restored when you touch . • When the frames are advanced one at a time in the reverse direction, they will be shown in intervals of 0.5 seconds. • Frame-by-frame playback of the scenes in iFrame or the scenes saved as MP4 will be shown in intervals of 1 second.

Playback operation	Playback display	Operating steps
Direct playback	<p data-bbox="322 190 493 215">During Playback</p> 	<p data-bbox="536 147 943 198">Touch the direct playback bar or slide it while touching.</p> <ul data-bbox="536 205 919 331" style="list-style-type: none"> <li data-bbox="536 205 919 278">● The playback pauses temporarily and skips to the position touched or slid to while touching. <li data-bbox="536 285 919 331">● Playback will start by releasing your touching or sliding finger.

Creating still picture from motion picture



A single frame from the recorded motion picture can be saved as a still picture.

3D still pictures will be saved for the scenes recorded in 3D, and 2D still pictures will be saved for the scenes recorded in 2D.

(**2.1M**) (1920×1080) still pictures will be recorded for the AVCHD scenes and iFrame scenes, and (**0.2M**) (640×360) still pictures will be recorded for the MP4 scenes.)

Press the  button fully at the location to be saved as a still picture during playback.

- It is convenient to use Pause, Slow-motion Playback and Frame-by-frame Playback.
- Date the motion picture was recorded will be registered as date of the still picture.
- Quality will be different from the normal still picture.

Highlight & Time Frame Index



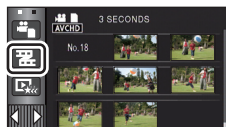

An image of one scene is displayed as a thumbnail at set search condition. Scene can be played back from any midway point of the scene you wish to see.

- Operate the zoom lever to  side and change over the thumbnail display to Highlight & Time Frame Index. (→ 28)



1 Touch .



- To display the next (previous) page:
 - Slide the thumbnail display upward (downward) while touching it.
 - Touch  (up) /  (down) on the thumbnail scroll lever. (→ 27)

2 Touch the desired search condition.

[3 SECONDS]/[6 SECONDS]/[12 SECONDS]/[MINUTES]/[FACE]*/[HIGHLIGHT]*

- * This cannot be set while playing back the scenes in iFrame or the scenes saved as MP4.
- When select [FACE], it will select the portion for which Face Recognition was performed from the scenes judged to be clearly recorded. This will then be displayed as a thumbnail.
- A portion judged to be clearly recorded will be detected and displayed in thumbnail if you select [HIGHLIGHT].



3 (When [MINUTES] is selected)

Touch  /  to set the time.

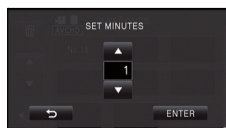
- It can be set up to a maximum of 60 minutes.
- Touch [ENTER].



4 Touch the thumbnail to be played back.

- Next (Previous) thumbnail can be displayed by touching  / .

Repeat Playback



Playback of the first scene starts after playback of the last scene finishes.

 : [VIDEO SETUP] → [REPEAT PLAY] → [ON]

The  indication appears on the full screen views.

- All the scenes are played back repeatedly. (When playing back motion pictures by date, all the scenes on the selected date are played back repeatedly.)

Resuming the previous playback



If playback of a scene was stopped halfway, the playback can be resumed from where it was stopped.

[MENU] : [VIDEO SETUP] → [RESUME PLAY] → [ON]

If playback of a motion picture is stopped,  appears on the thumbnail view of the stopped scene.

- The memorised resume position is cleared if you turn off the unit or change the mode. (The setting of [RESUME PLAY] does not change.)

Zooming in on a still picture during playback (Playback zoom)



You can zoom in by touching a still picture during playback.

1 Touch and hold the part you wish to zoom in on during still picture playback.

- It will display enlarged in order of normal display ($\times 1$) \rightarrow $\times 2$ \rightarrow $\times 4$. Touch and hold the screen to zoom in from the normal display $\times 1$ to $\times 2$. Touch the screen to zoom in from $\times 2$ to $\times 4$.
- The still picture is zoomed in on, centring on the part you touched.

2 Move to the zoomed in position by touching / / / or slide while touching the screen.

- The location of the zoom displays for about 1 second when zooming in (zooming out) or moving the displayed location.
- The more picture is enlarged, the more its quality deteriorates.

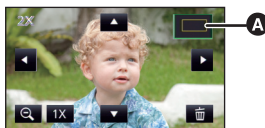

- A** Displayed location of the zoom

Zooming out from the zoomed still picture

Touch  to zoom out. ($\times 4$ \rightarrow $\times 2$ \rightarrow $\times 1$)

- Touch  to return to normal playback ($\times 1$).

- You can also perform zoom operations using the zoom lever.
- Playback zoom cannot be performed for the still pictures recorded in 3D. It will perform the playback zoom after switching to 2D playback when the zoom operation is performed.

Various playback functions

Playing back motion pictures/still pictures by date



The scenes or the still pictures recorded on the same day can be played back in succession.

1 Touch the date select icon. (→ 16)

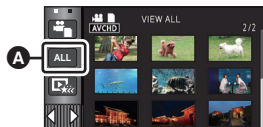



A Date select icon

2 Touch the playback date.

The scenes or the still pictures recorded on the date selected are displayed as thumbnails.

3 Touch the scene or the still picture to be played back.

- Playing back of all the scenes or the still pictures returns if the unit is turned off or the mode is changed.
- Even if AVCHD scenes are recorded on the same day, they are grouped separately when the number of scenes exceeds 99. -1, -2... is added after the recording date displayed on the screen.
- Even if AVCHD scenes are recorded on the same day, they are grouped separately whenever the 1080/50p recording, 1080/50i recording, or side-by-side recording are switched. -1, -2 ... are added after the date displayed on the date list.
- Even if iFrame scenes are recorded on the same day, they are grouped separately in the following cases. -1, -2... is added after the recording date displayed on the screen.
 - When the number of scenes exceeds 99
 - When [NUMBER RESET] is performed
- Even if still pictures are recorded on the same day, they are grouped separately in the following cases.
 - When the number of still pictures exceeds 999
 - When pictures are recorded in Hi-Speed Burst Shooting Mode ( is indicated after the date in the list by date).
 - When [NUMBER RESET] is performed
-  is displayed after the date in the list by date for the still pictures created from the motion picture. (→ 77)

Highlight Playback



Part that was recognised as clearly recorded is extracted from a long recording, and it can be played back in a short time with effects and music added. It can be saved as a single scene. It is also possible to create an original Highlight Playback by checking your favourite scenes and setting up to extract those scenes.

- **Highlight Playback is not possible for the scenes in iFrame or the scenes saved as MP4.**

1 Touch . (→ 16)

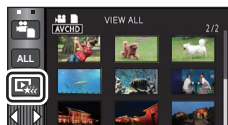

2 Touch the desired effect.

[POP]:	Recommended for enjoyable situations such as party scene.
[NATURAL]:	Recommended for scenery.
[CLASSICAL]:	Recommended for slow moving scene.
[DYNAMIC]:	Recommended for fast moving scene such as sports scene.
[CUSTOM]:	Set the combination of the effect and the music. (→ 82)

- The scenes matching the effect will be extracted and displayed in the thumbnail view.
- Effects such as fade, slow-motion, still (pause), or digest playback are inserted.
- It will be played back with the date of last recording. To change the settings, refer to page 83.

3 Touch in the thumbnail view.

- To change the settings, refer to page 83.

4 Select the playback operation. (→ 27, 76)

- When the playback is finished or stopped, the screen to select [SAVE] (→ 86), [SELECT AGAIN] or [EXIT] is displayed. Touch the desired item.

- Playing back of all the scenes returns if the unit is turned off or the mode is changed.
- Slow-motion Playback and Frame-by-frame Playback are not possible.

Setting up the custom effect

It is possible to enjoy the Highlight Playback with your favourite effect by setting up the combination of an image effect and music.

1 Touch [CUSTOM].

2 Touch [EFFECT SETUP] or [MUSIC SELECT].

3 (When [EFFECT SETUP] is selected)

Touch the desired effect.

- When [EFFECT SETUP] is changed, [MUSIC SELECT] will be set the same as [EFFECT SETUP]. (To set [EFFECT SETUP] and [MUSIC SELECT] to different settings, change [MUSIC SELECT] after setting [EFFECT SETUP].)

(When [MUSIC SELECT] is selected)

Touch the desired sound.

- When [EFFECT SETUP] is set to [NONE], you will be able to select [NO MUSIC]. When [NO MUSIC] is selected, the audio recorded at the time of shooting is played back.
- To adjust the volume of music during playback or audio testing, operate the volume lever. (→ 28)

4 Touch [ENTER].

To test the music audio

Touch [START].

- Touch the other music option to change the music to be tested.
- When you touch [STOP], the music playback stops.

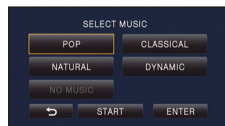
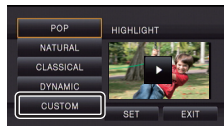

Playing back with the settings changed

Touch [SET] to select the item to change.

[SCENE SETUP]: Select the scene or date to be played back.

[FAVOURITE SCENE SETUP]: Set up the favourite scenes. (→ 84)

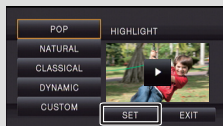

[FAVOURITE SCENE PLAY]: Set up if the favourite scenes are to be included in the Highlight Playback or not. (→ 84)

[PRIORITY SETUP]: Select the target to give priority to play back. (→ 85)

[PLAYBACK TIME]: Select the time to play back. (→ 85)

[TITLE SETUP]: Select the title sheet to be displayed at the beginning, and enter the title. (→ 85)

■ Scene setting

1 (Only when Highlight Playback is started from [ALL AVCHD])

Touch the recording format of the scene to be played back.

[1080/50p]/[1080/50i]/[SbS 3D]

2 Touch [SELECT DATE] or [SELECT SCENES].

3 (When [SELECT DATE] is selected)

Touch the date to be played back.

- A maximum of 7 days can be selected.
- When touched, the date is selected and surrounded by red. Touch the date again to cancel the operation.



(When [SELECT SCENES] is selected)

Touch the scenes to be played back.

- Up to 99 scenes can be selected in succession.
- When touched, the scene is selected and ✓ is displayed. Touch the scene again to cancel the operation.

4 Touch [Enter]/[ENTER].

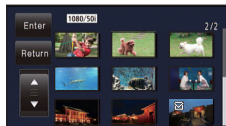

■ Checking the favourite scenes

1 Touch the scenes to be played back.

2 Touch [Add] and add the favourite part.

- Approximately 4 seconds before and after touching [Add] will be added as favourite.
- Number of favourite scenes that can be added are 1 to 14. (Number of scenes that can be added differs depending on the scenes selected.)
- Favourite check display √ (A) is displayed in orange, and favourite check display B is displayed on the slide bar.
- To cancel the favourite, play back to the position checked as favourite, and touch [Cancel].
- It is convenient to use Slow-motion Playback and Frame-by-frame Playback. (→ 76)

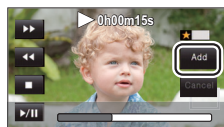

3 Touch [Stop] and stop the playback.

- It will return to the thumbnail display screen and ★ is displayed on the scenes added as favourite scenes.

-
- All the scenes checked as favourite may not be played back depending on the playback time setting. (→ 85)

To clear the favourite scenes from the thumbnail display

1 Touch [Reset].

2 Touch [RESET ALL] or [RESET SELECTED].

- The check on all the favourite scenes will be cleared when [RESET ALL] is selected.

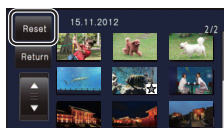

3 (When [RESET SELECTED] is selected in step 2)

Touch the scene to be cleared.

4 Touch [YES].

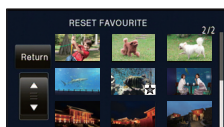

■ Playing back the favourite scenes

Touch [ON] or [OFF].

[ON]: Include the scenes added in the [FAVOURITE SCENE SETUP] into the Highlight Playback.

[OFF]: Do not include the scenes added in the [FAVOURITE SCENE SETUP] into the Highlight Playback.

■ Priority settings

1 Touch [FACE] or [FACE RECOG].

- If you touch [FACE], any detected face, including the face of person registered for Face Recognition, is given priority on playback.

2 (When [FACE RECOG.] is selected)

Touch a face to specify.

- You can specify up to 6 faces, which are to be played back in priority.
- When touched, the registered face is selected and surrounded by red. Touch the registered face again to cancel the operation.
- Touch [ENTER]. When a single face is specified, the name registered for that face is displayed. When multiple faces are specified, the number of faces is displayed.

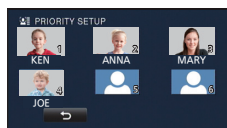

■ Playback time setting

Touch the playback time.

- The playback time of [AUTO] is a maximum of approx. 5 minutes.
- Playback time may become shorter than the setting, or it may not even be played back if the part recognised as clearly recorded is short.

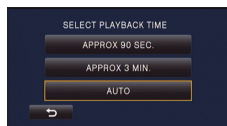

■ Setting up the title

1 Touch [◀] / [▶] to select your favorite title sheet.

[NONE]/[PICTURE 1]/[PICTURE 2]/[PICTURE 3]/[PICTURE 4]

- Title and date will not be displayed when [NONE] is selected.

2 Touch [TITLE].

3 Enter the title.

- Input method is same operation as for the face recognition. (→ 57)

- Touch [Enter] after entering the title.
- A maximum of 18 characters can be entered.

4 Touch [ENTER] to end registration.

- The date of the first scene of the Highlight Playback will be displayed as the date.



- The entered title will be cleared when the unit is turned off or the Highlight Playback is finished.

Saving the Highlight Playback

The scenes put together as a Highlight Playback can be saved as a single scene. The scenes recorded on the SD card can be saved on the SD card.

HC-V700M

The scenes recorded on the built-in memory can be saved on the built-in memory.

- 1 **Stop the playback of the Highlight Playback or wait until the Highlight playback is finished.**
- 2 **Touch [SAVE].**
- 3 **Select the format to save.**

[QUALITY (AVCHD)]:	It will be saved in high definition image quality.
[COMPATIBILITY (MP4)]:	It will be saved in image quality (640×360/25p) appropriate for playing back on a PC or uploading to Internet.

- When [QUALITY (AVCHD)] is selected, scenes recorded in 1080/50p are converted to 1080/50i (picture quality [HA] of [REC MODE]) and saved.
- It will be saved in [HA] picture quality when [1080/50i] is selected in [SCENE SETUP] and scene with different [REC MODE] ([HA]/[HG]/[HX]/[HE]) is selected.

4 **Touch [YES].**

- Playback operation is not possible while playing back the scenes to be saved.

5 (When saved on the SD card)

Touch [EXIT].

HC-V700M

(When saved in the built-in memory)

Touch [COPY] or [EXIT].

- The Highlight Playback saved in the built-in memory can be copied to the SD card. To copy to the SD card, select [COPY].
 - Operate according to the message and touch [EXIT] at the end.
-
-  is displayed on the thumbnail of the scenes saved by the Highlight Playback.

Changing the playback settings and playing back the slide show



1 Touch . (→ 16)

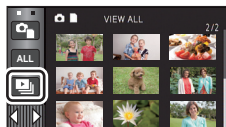

2 (Only when you would like to change the settings)

Touch [SET] to select the item to change.

[DATE SETUP]:	Select the date to be played back.
[PLAYBACK SETUP]:	Select to play back in 3D (2D still pictures are converted to 3D still pictures and played back) or play back in 2D (3D still pictures are converted to 2D still pictures and played back).
[SLIDES INTERVAL]:	Select the interval between still pictures at playback.
[EFFECT SETUP]:	Select the effect for playback.
[MUSIC SELECT]:	Select the music to be played on playback.

3 (When [DATE SETUP] is selected)

Touch the playback date.

(When [PLAYBACK SETUP] is selected)

Touch [3D (NO EFFECT)] or [2D].

(When [SLIDES INTERVAL] is selected)

Touch the interval of playback for the slide show.

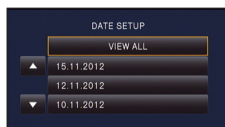

[SHORT]:	Approx. 1 second
[NORMAL]:	Approx. 5 seconds
[LONG]:	Approx. 15 seconds

(When [EFFECT SETUP] is selected)

Touch the desired effect.

- When [EFFECT SETUP] is changed, [MUSIC SELECT] will be set the same as [EFFECT SETUP]. (To set [EFFECT SETUP] and [MUSIC SELECT] to different settings, change [MUSIC SELECT] after setting [EFFECT SETUP].)
- [SLIDES INTERVAL] cannot be set, when [EFFECT SETUP] is set.



(When [MUSIC SELECT] is selected)

Touch the desired sound.

- To adjust the volume of music during playback of the slide show or audio testing, operate the volume lever. (→ 28)
- Touch [ENTER].

(To test the music audio)

Touch [START] and start the audio testing.

- Touch the other music option to change the music to be tested.
- When you touch [STOP], the music playback stops.

4 Touch [START].

5 Select the playback operation. (→ 27)

- When the playback is finished or stopped, the screen to select [REPLAY], [SELECT AGAIN] or [EXIT] is displayed. Touch the desired item.

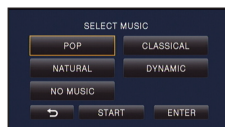

Deleting scenes/still pictures

Deleted scenes/still pictures cannot be restored, so perform appropriate confirmation of the contents before proceeding with deletion.

◇ Change the mode to  .

■ To delete the scene or still picture being played back

Touch  while scenes or still pictures to be deleted are being played back.



■ To delete scenes or still pictures from the thumbnail display

- Switch to the thumbnail display of the scenes or still pictures to delete. (→ 27)
- The Touch Menu will disappear after approximately 5 seconds, and  is displayed.

1 Touch  . (→ 27)

- When the thumbnail display is 1 scene display or Highlight & Time Frame Index, the scene or still picture being displayed is deleted.

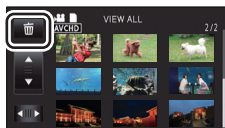

2 Touch [ALL SCENES], [MULTI] or [SINGLE].

- All the scenes or still pictures displayed as thumbnails will be deleted by selecting [ALL SCENES].
(In case of playing back scenes or still pictures by date, all the scenes or still pictures on the selected date will be deleted.)
- Protected scenes/still pictures cannot be deleted.

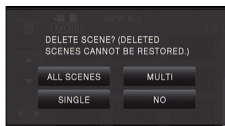

3 (When [MULTI] is selected in Step 2)

Touch the scene/still picture to be deleted.

- When touched, the scene/still picture is selected and the  indication appears on the thumbnail. Touch the scene/still picture again to cancel the operation.
- Up to 99 scenes can be selected to be deleted.

(When [SINGLE] is selected in Step 2)

Touch the scene/still picture to be deleted.

- Touched scene or still picture is deleted.

4 (When [MULTI] is selected in Step 2)

Touch [Delete].

- To continuously delete other scenes/still pictures, repeat Steps 3-4.



When you stop deleting halfway:

Touch [CANCEL] while deleting.

- The scenes or still pictures that have already been deleted when the deletion is cancelled cannot be restored.

To complete editing:

Touch [Return].

-
- You can also delete scenes by touching , selecting [EDIT SCENE] → [DELETE] → [ALL SCENES], [MULTI] or [SINGLE].
 - You can also delete still pictures by touching , selecting [PHOTO SETUP] → [DELETE] → [ALL SCENES], [MULTI] or [SINGLE].
 - During Highlight Playback or Disc Playback when connected to a DVD burner (optional), scenes/still pictures cannot be deleted.
 - Scenes that cannot be played back (the thumbnails are displayed as ) cannot be deleted.
 - In case of [ALL SCENES], the deletion may take time if there are many scenes or still pictures.
 - If you delete scenes recorded on other products or still pictures conforming to DCF standard with this unit, all the data related to the scenes/still pictures may be deleted.
 - When still pictures recorded on an SD card by other products are deleted, a still picture (other than JPEG) that cannot be played back on this unit, may be erased.

Deleting part of a scene (AVCHD)



Unnecessary part of an AVCHD scene can be deleted.

The deleted scenes cannot be restored.

- Change the mode to  and touch the play mode select icon. Then, select the AVCHD scene. (→ 27)

1 Select the menu.

MENU : [EDIT SCENE] → [SECTION DELETE]

2 Touch the scene with a part to delete.

3 Set the section to delete by touching and sliding the top and bottom section selection buttons .

- It is convenient to use Slow-motion Playback and Frame-by-frame Playback. (→ 76)

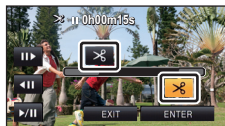

4 Touch [ENTER].

5 Confirm (play back) the scene after editing by touching [YES].

- A confirmation message appears when [NO] is touched. Proceed to Step 7.

6 Stop the playback.

- A confirmation message appears.

7 Touch [ENTER].

- Repeat steps 2-7 to continuously delete parts from other scenes.

-
- Deleting of part cannot be performed when there are 99 scenes in a single date.
 - It may not be possible to delete part of a scene with a short recording time.
 - The scene will be divided into two scenes when middle part of a scene is deleted.
 - The relay information is deleted when part of a scene that was relay recorded is deleted, making it impossible to perform the Relay scene combining. (→ 95)

Dividing a scene (AVCHD)



It is possible to divide an AVCHD scene.

Any unwanted parts in the scene can be deleted after dividing.

- Change the mode to  and touch the play mode select icon. Then, select the AVCHD scene. (→ 27)

1 Select the menu.

MENU : [EDIT SCENE] → [DIVIDE] → [SET]

2 Touch the scene to be divided.

3 Touch to set the dividing point.

- It is convenient to use Slow-motion Playback and Frame-by-frame Playback. (→ 76)
- Touch [YES] to continue dividing the same scene. To continue dividing other scenes, touch [NO] and repeat Steps 2-3.



4 Touch [Return] to complete dividing.

- Unwanted parts can be deleted. (→ 89)

To delete all the divided points

MENU : [EDIT SCENE] → [DIVIDE] → [CANCEL ALL]

- The scenes that were deleted after division cannot be recovered.

- You cannot divide a scene if you are playing back a disc with a DVD burner (optional) connected, or if the number of scenes of a given date would exceed 99 scenes.
- It may not be possible to divide scenes with a short recording time.
- Data that has been recorded or edited on another device cannot be divided and the divided points cannot be deleted.
- If personal information in the divided scenes is deleted, the personal information is deleted when the divided scenes are cancelled.

Dividing a scene to partially delete (iFrame/MP4)



Divide the iFrame scene or the scene saved as MP4, and delete unnecessary parts. This divides the recorded scenes in two and deletes the front half or back half.

The scenes deleted by dividing cannot be restored.

- Change the mode to  and touch the play mode select icon. Then, set to [iFrame] or [MP4]. (→ 27)

1 Select the menu.

 : [EDIT SCENE] → [SPLIT&DELETE]

2 Touch the scene to be divided.

3 Touch to set the dividing point.

- It is convenient to use Slow-motion Playback and Frame-by-frame Playback. (→ 76)
- Set the dividing point so there will be 2 seconds or more for the part for deletion, and 3 seconds or more for the part to be kept.

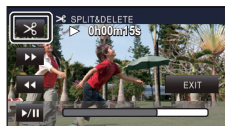

4 Touch the part for deletion.

5 Touch [YES] and confirm (play back) the part for deletion.

- A confirmation message appears when [NO] is touched. Proceed to Step 7.

6 Stop the playback.

- A confirmation message appears.

7 Touch [YES].

- To continue dividing and deleting other scenes, repeat Steps 2-7.

To complete editing

Touch [Return].

-
- It may not be possible to divide scenes with a short recording time.
 - The actual division may slightly slip off the previously designated dividing point.

Deleting personal information







Deletes Face Recognition information from scenes in which faces were recognised.

- Change the mode to  and touch the play mode select icon. Then, select the AVCHD scene. (→ 27)
- Face Recognition information is not recorded in the scenes recorded in iFrame or the scenes saved as MP4.

1 Select the menu.

 : [VIDEO SETUP] → [DELETE PERSONAL INFO]

2 Touch the desired scenes with personal information to be deleted.

-  appears at scenes for which faces were recognised.  will change to  (red) when touched. Touch the  (red) again to cancel the operation.
- Up to 99 scenes can be selected in succession.

3 Touch [Delete].

- To continuously delete other personal information, repeat Steps 2-3.
- Touch [Return] to complete the settings.

When you stop deleting halfway

Touch [CANCEL] while deleting personal information.

- The personal information that has already been deleted when the deletion is cancelled cannot be restored.

-
- During Disc Playback when connected to a DVD burner (optional), personal information cannot be deleted.

Protecting scenes/still pictures



Scenes/still pictures can be protected so that they are not deleted by mistake.

(Even if you protect some scenes/still pictures, formatting the media will delete them.)

- Change the mode to  .

1 Select the menu.

 : [VIDEO SETUP] or [PHOTO SETUP] → [SCENE PROTECT]

2 Touch the scene/still picture to be protected.

- When touched, the scene/still picture is selected and the  indication appears on the thumbnail. Touch the scene/still picture again to cancel the operation.
- Touch [Return] to complete the settings.

-
- When the Disc Playback is selected while a DVD burner (optional) is connected, scenes/still pictures cannot be protected.

Relay scene combining [HC-V700M]



You can combine the relayed scene (→ 56) in the built-in memory and the continued scene in the SD card to be one into the SD card.

Relay-recorded scene

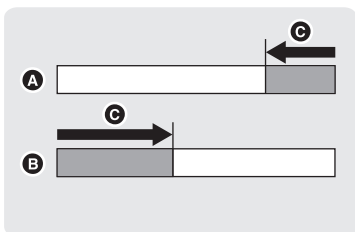

Relay scene combining

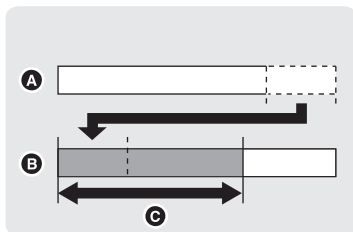

- A** Built-in memory
- B** SD card
- C** Range of Relay Recording

- Change the mode to and touch the play mode select icon. Then, select the AVCHD scene. (→ 27)

1 Insert the SD card that was used for Relay Recording.

2 Select the menu.

MENU : [EDIT SCENE] → [RELAY SCENE COMBINE]

3 When the confirmation message appears, touch [YES].

- Scene in the built-in memory will be deleted. (Protected scenes in the built-in memory are not deleted.)

4 Touch [EXIT] when the relay scene combining complete message is displayed.

- The thumbnail view of the SD card is indicated.
- Relay Recording information will be deleted when the relay scenes are combined, and Relay Recording will be possible again.
- When the relayed scenes in the built-in memory or SD card are deleted, combining of the relayed scenes will not be possible.

To cancel relay information

 : [EDIT SCENE] → [RELAY INFO CANCEL]

- When the relay information is cancelled, combining of the relayed scenes will not be possible anymore.

Combining of the relay scene cannot be performed if the available space on the SD card is less than the volume of the relayed scene in the built-in memory. It is recommended to combine the relay scene using a DVD burner or the HD Writer AE 4.0.

- When the Disc Playback is selected while a DVD burner (optional) is connected, you cannot combine relay scenes or cancel relay information.
- The personal information of the relayed scene in the built-in memory or SD card is deleted, the personal information of the combined relay scene is deleted.

Watching Video/Pictures on your TV



Confirm the terminals on your TV and use a cable compatible with the terminals. Image quality may vary with the connected terminals.

- A** High quality
- 1** HDMI terminal
- 2** Component terminal
- 3** Video terminal

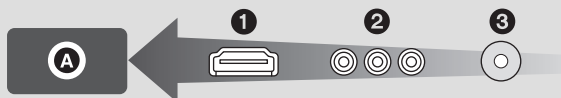

- Use the AV multi cable (supplied) or HDMI mini cable (optional) and check the output settings. (→ 100)
- HDMI is the interface for digital devices. If you connect this unit to a HDMI compatible high definition TV and then play back the recorded high definition images, you can enjoy them in high resolution with high quality sound.

1 Connect this unit to a TV.

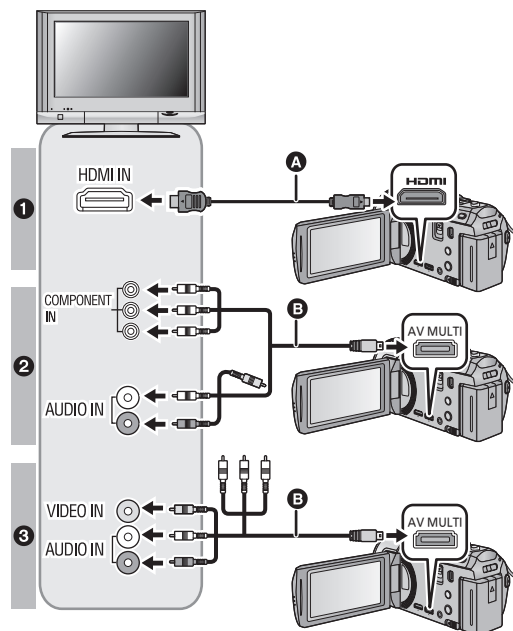

- A** HDMI mini cable (optional)
- Be sure to connect to the HDMI terminal.
- B** AV multi cable (supplied)

Picture quality

- 1** High definition images when connecting to HDMI terminal
- 2** High definition images when connecting to component terminal compatible with 1080i
Standard images when connecting to component terminal compatible with 576i
- 3** Standard images when connecting to video terminal

- Check that the plugs are inserted as far as they go.
- Always use a genuine Panasonic HDMI mini cable (RP-CDHM15, RP-CDHM30: optional).
- Do not use any other AV multi cables except the supplied one.
- When connecting to the component terminal of the TV, the yellow plug of the AV multi cable is not required.
- When connecting to the AV terminal of the TV, do not connect the component terminal plug of the AV multi cable. Image may not display when the component terminal plug is connected simultaneously.

2 Select the video input on the TV.

- Example:
Select the [HDMI] channel with a HDMI mini cable.
Select the [Component] or [Video 2] channel with an AV multi cable.
(The name of the channel may differ depending on the connected TV.)
- Check the input setting (input switch) and the audio input setting on the TV. (For more information, please read the operating instructions for the TV.)

3 Change the mode to to play back.

Cables	Reference items
A HDMI mini cable (optional)	<ul style="list-style-type: none"> • Connecting with a HDMI mini cable (→ 100) • Playback using VIERA Link (→ 101)
B AV multi cable (supplied)	<ul style="list-style-type: none"> • Connecting with the AV multi cable (→ 100)



- When the AV multi cable is connected to this unit, the setup screen of the AV multi destination is displayed on the screen of this unit. Touch either [COMPONENT] or [AV OUT] in accordance with the terminal connecting to the TV. (→ 100)
- If the HDMI mini cable and AV multi cable are connected at the same time, output will be prioritised in order of the HDMI mini cable, AV multi cable.

■ **To watch images on a regular TV (4:3) or when both sides of the images do not appear on the screen**

Change the menu setting to display the images correctly. (Check the TV setting.)

MENU : [SETUP] → [TV ASPECT] → [4:3]

Example of images with a [16:9] aspect ratio on a regular TV (4:3)

[TV ASPECT] setting	
[16:9]	[4:3]
	

- If a wide-screen TV is connected, adjust the aspect setting on the TV. (Refer to the operating instructions of the TV for details.)

■ **To display the on-screen information on the TV**

When the menu setting is changed, the information displayed on the screen (operation icon and time code etc.) can be displayed/not displayed on the TV.

MENU : [SETUP] → [EXT. DISPLAY] → **desired setting**

[SIMPLE]*:	Information partially displayed
[DETAIL]:	All information displayed
[OFF]:	Not displayed

- * This setting is only available in recording mode.

Refer to the following support site for information about the Panasonic TVs that you can directly insert an SD card into the SD card slot on the TV and then play it back.
<http://panasonic.net/>

- It may not be possible to play back scenes on the TV depending on the recording mode.
- For details on how to play back, please read the operating instructions for the TV.

Connecting with a HDMI mini cable

Select the desired method of HDMI output.

MENU : [SETUP] → [HDMI RESOLUTION] → [AUTO]/[1080p]/[1080i]/[576p]

- [AUTO] determines the output resolution automatically based on information from the connected TV.
If the images are not output on the TV when the setting is [AUTO], switch to the method [1080p], [1080i] or [576p] which enables the images to be displayed on your TV. (Please read the operating instructions for the TV.)
- Image will not display on TV for a few seconds in the following cases.
 - When the 1080/50p recording mode is turned on/off during Motion Picture Recording Mode
 - When you touch the play mode select icon to select [1080/50p] and then touch [ENTER] during Playback Mode
 - When the play mode selection is set to  in the Playback Mode, and it is switched between the 3D still picture and the 2D still picture
 - When the 1080/50p, 1080/50i, or side-by-side scenes are switched.

Connecting with the AV multi cable

Select the desired setting of AV multi connector output.

MENU : [SETUP] → [AV MULTI] → desired setting

[COMPONENT]: When connecting to the component terminal

[AV OUT]: When connecting to the video terminal

Changing the component output setting

MENU : [SETUP] → [COMPONENT OUT] → desired setting

[1080i]: When connecting to the component terminal on the TV compatible with 1080i. (Playback is in high definition quality.)

[576i]: When connecting to the component terminal on the TV compatible with 576i. (Playback is in standard quality.)

- Set [VIDEO LIGHT] to [OFF] when recording with the TV connected to the component terminal to confirm the recording. (→ 53)

Playback using VIERA Link



What is the VIERA Link (HDAVI Control™)?

- This function allows you to use your remote control for the Panasonic TV for easy operations when this unit has been connected to a VIERA Link compatible device using a HDMI mini cable (optional) for automatic linked operations. (Not all operations are possible.)
- VIERA Link is a unique Panasonic function built on a HDMI control function using the standard HDMI CEC (Consumer Electronics Control) specification. Linked operations with HDMI CEC compatible devices made by other companies are not guaranteed. When using devices made by other companies that are compatible with VIERA Link, refer to the operating instructions for the respective devices.
- This unit is compatible with VIERA Link Ver.5. VIERA Link Ver.5 is the newest Panasonic version and is also compatible with existing Panasonic VIERA Link devices. (As of Nov. 2011)

◇ Change the mode to .

1 Select the menu.

: [SETUP] → [VIERA Link] → [ON]

- If you are not using VIERA Link, set to [OFF].

2 Connect this unit to a Panasonic TV compatible with VIERA Link with a HDMI mini cable.

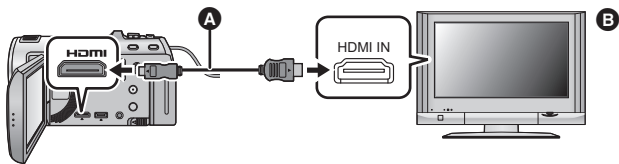

- A** HDMI mini cable (optional)
- B** Panasonic TV compatible with VIERA Link
- It is recommended to connect this unit to an HDMI terminal other than the HDMI1 if there are 2 or more HDMI input terminals on the TV.
- VIERA Link must be activated on the connected TV. (Read the operating instructions of the TV for how to set etc.)
- Always use a genuine Panasonic HDMI mini cable (RP-CDHM15, RP-CDHM30: optional).

3 Operate with the remote control for the TV.

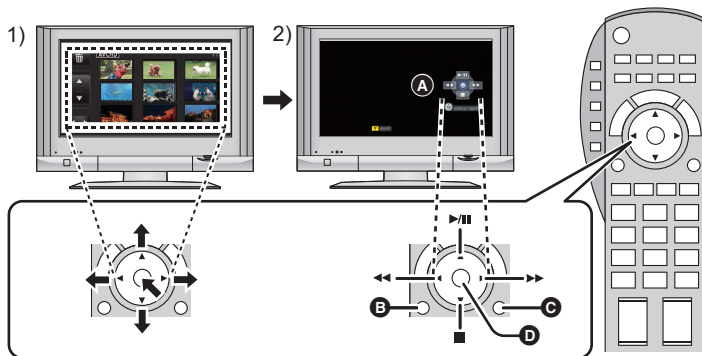

- 1) Press the button up, down, left or right to select a scene or still picture to be played back, and then press the button in the centre to set it.
- 2) Activate the operation icons that are displayed on TV screen with the remote control for the TV.

A Operation icons

B Display operation icons

C Cancel operation icons

D Display/Cancel operation icons

• The following operations are available by pressing the colour buttons on the remote control.

– Green: Switching the number of scenes/still pictures in thumbnail display
(9 thumbnails → 20 thumbnails → 9 thumbnails...)

Zoom in on still picture

– Yellow: Deleting scenes/still pictures

– Red: Zoom out from still picture/Adjusting 3D effect of the 3D image

■ Other linked operations

Turning the unit off:

If you use the remote control for the TV to turn off the power, this unit also turns off.

Automatic input switching:

If you connect with a HDMI mini cable and then turn on this unit, the input channel on the TV automatically switches to this unit's screen. If the TV's power is in standby status, it will turn on automatically (if [Set] has been selected for the TV's [Power on link] setting).

• Depending on the HDMI terminal on the TV, the input channel may not switch automatically. In this case, use the remote control for the TV to switch the input channel.



- If you are unsure whether or not the TV and AV amplifier you are using are compatible with VIERA Link, read the operating instructions for the devices.
- Available linked operations between this unit and a Panasonic TV is different depending on the types of Panasonic TVs even if they are compatible with VIERA Link. Refer to the operating instructions of the TV for the operations that support on the TV.
- Operation is not possible with a cable that is not based on the HDMI standard.

Advanced (Playback)

3D image playback



Connect the unit to a 3D compatible television and play back scene/still picture recorded in 3D to enjoy life-like and powerful 3D image.

- ◇ **Change the mode to  and touch the play mode select icon. Then, select the AVCHD scene or set to  . (→ 27)**



1 Select the menu.

MENU : [SETUP] → [3D PLAYBACK] → [AUTO]

- [AUTO]:** The scene/still picture recorded in 3D is played back in accordance with the settings on the TV.
- [2D]:** The scene/still picture recorded in 3D is played back in 2D irrespective of the settings on the TV.

2 Connect the unit to 3D compatible television using the HDMI mini cable (optional) or the AV multi cable (supplied). (→ 97)

3 Play back scenes or still picture recorded in 3D.

-  is displayed in the thumbnail display at playback for the scenes recorded in 3D.
-  is displayed in the still pictures recorded in 3D.
- Playback switches between 3D image and 2D image automatically.
- If your television does not switch to a 3D image, make the necessary settings on the TV. (For further details, please read the operating instructions for the TV.)

- **Set to [2D] when using a television that is not 3D compatible.**
- **If you feel tired, uncomfortable or otherwise strange when viewing scenes recorded in 3D, set to [2D].**



- You cannot play back 3D image on the LCD monitor of the unit. When you play back scenes recorded in 3D on the LCD monitor, they will be played back in 2D.
- You can also play back scenes recorded in 3D by date. Even if scenes are recorded on the same day, the unit will display the date separately when switching between 2D and 3D recordings. (→ 80)
- When you play back scenes successively, a black screen will appear for a few seconds between scenes recorded in 3D and scenes recorded in 2D.
- When you select a 3D thumbnail, it may take a few seconds for playback to start. After playback, the thumbnail display may take a few seconds to reappear.
- It will play back in 2 screens when connected to the TV not compatible with 3D using an AV multi cable (supplied).
- Depending on the 3D-compatible television used, switching to 3D mode may be slow and you may not be able to watch the first scene. In this case, use the pause button.
- When viewing 3D image, your eyes may become tired if you are too close to the television screen.

Advanced (Playback)

Converting and playing back 2D images as 3D



You can connect this unit to 3D compatible TV, convert the scene/still picture recorded in 2D (conventional image) to 3D and play back.

- ◇ **Change the mode to  and touch the play mode select icon. Then, select the AVCHD scene or set to . (→ 27)**

MENU : [VIDEO SETUP] or [PHOTO SETUP] → [CONV. 2D TO 3D] → [ON]

[ON]: Convert and play back the images recorded in 2D as 3D images. (3D scenes are played back as 3D.)

[OFF]: Recorded images are played back as it was recorded.

Setting with the Touch Menu

1 Touch 2D+3D.

- This is not displayed when playing back the iFrame or scenes saved as MP4.

2 Play back the scene or the still picture by touching it.

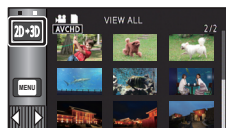

-
- Setting for the [3D PLAYBACK] is not possible when [CONV. 2D TO 3D] is set to [ON].
 - [CONV. 2D TO 3D] setting takes priority regardless of the [3D PLAYBACK] setting.
 - Highlight Playback cannot be converted to 3D image.
 - Scenes/still pictures converted to 3D images cannot be saved as 3D images.

■ Adjusting 3D effect of the 3D image

It is possible to adjust the disparity of the scenes and still pictures playing back in 3D for better view.

1 Play back scenes or still pictures recorded in 3D.

2 Touch .

- Playback disparity adjustment bar is displayed while displaying in 3D.



3 Touch / to adjust settings.

- Playback disparity adjustment bar will disappear after approx. 5 seconds without any touch operation.

-
- The setting is cancelled in following cases:
 - If you stop playback
 - If you turn the unit off
 - If you change the mode

- **Stop the operation when you feel fatigue, discomfort, or otherwise strange while playing back or adjusting.**

Copying between SD card and Built-in Memory [HC-V700M]



Motion pictures or still pictures recorded with this unit can be copied between an SD card inserted in this unit and a built-in memory.

■ Check the used space of the copy destination

It is possible to check the used space of the SD card or built-in memory by [MEDIA STATUS]. (→ 38)

- By displaying in 1 scene or touching and holding the thumbnail in the 20 scenes or 9 scenes display, recording date and time can be checked when playing back motion pictures, and recording date and file number when playing back still pictures.
- Depending on the media condition, some remaining capacity of the SD card or built-in memory may not be used.
- If the remaining capacity on a single SD card is not enough, you can copy to multiple SD cards following the instruction on the screen. In this case, the last scene copied to an SD card is automatically divided to fit the space on the SD card.
- If you divide the scenes (→ 92), and copy by scene selection, it is possible to copy matching the remaining capacity of the media, or only the necessary parts.

Copying











- If there is little or no remaining capacity in the SD card, a confirmation message asking to copy after deleting all data on the SD card is displayed. Be aware that deleted data cannot be restored.
- Refer to page 108 for approximate time for copying.

1 Change the mode to .

- Use a sufficiently charged battery or the AC adaptor.



2 Select the menu.

 : [COPY]

[ → ]	When copying from the SD card to the built-in memory
[ → ]	When copying from the built-in memory to the SD card
[ →  CONVERT FORMAT]	This will convert the recording format and copy from the built-in memory to the SD card.
[AVCHD  →  MP4]	This will convert the scene recorded in AVCHD on the built-in memory to MP4 (640×360/25p) and copy to the SD card.
[1080/50p  →  1080/50i]	This will convert the scene recorded in 1080/50p on the built-in memory to 1080/50i and copy to the SD card.

- When there are relay-recorded scenes in the built-in memory, a message appears on the screen. Touch [YES] and copy after combining relay-recorded scenes to the SD card. (→ 95)

3 Touch desired items following the screen display.

- It will return to the previous step by touching .
- (When [SELECT SCENES] is selected)
When touched, the scene/still picture is selected and the  indication appears on the thumbnail. Touch the scene/still picture again to cancel the operation.
- (When [SELECT DATE] is selected)
When touched, the date is selected and surrounded by red. Touch the date again to cancel the operation.
- Up to 99 scenes/still pictures or 99 dates can be set in succession.
- If 2 or more SD cards are necessary to copy, change the card following the instructions on the screen.

4 Touch [EXIT] when the copy complete message is displayed.

- The thumbnail view of the copy destination is indicated.

When you stop copying halfway

Touch [CANCEL] while copying.

Approximate time for copying

When copying a recorded motion picture of full 4 GB size:

Approx. 5 minutes to 15 minutes

When performing [1080/50p →] on a recorded 1080/50p motion picture of full 4 GB size:

Approx. 20 minutes to 30 minutes

When performing [AVCHD →] on a recorded AVCHD (HA) motion picture of full 4 GB size:

Approx. 30 minutes to 40 minutes

To copy approx. 600 MB still pictures (Picture size):

Approx. 3 minutes to 5 minutes

If you will delete the motion pictures or still pictures after copying is complete, be sure to play back the motion pictures or still pictures to check that they have been copied to correctly before deleting.

- When the Disc Playback is selected while a DVD burner (optional) is connected, menus are not displayed.
- Depending on the following conditions, the time it takes for copying may be longer.
 - The number of recorded scenes is large.
 - The temperature of the unit is high.
- If some motion pictures or still pictures have already been recorded to the copy destination, then the same date may be assigned or images may not display by date when the list by date is selected.
- When converting and copying the scenes recorded in AVCHD to MP4 scene, the scene exceeding approximately 20 minutes is automatically divided.
- Motion pictures that have been recorded on another device may not be copied. Data recorded on a PC with HD Writer AE 4.0, etc. cannot be copied.
- The settings for the copied motion picture and still pictures will be cleared if the protected motion pictures or still pictures are copied.
- The order in which the scenes or still pictures were copied cannot be changed.

Connecting a DVD burner to copy to/ play back a disc



Motion pictures or still pictures recorded with this unit can be copied to a DVD disc by connecting a DVD burner (optional) to this unit using a USB Connection Cable (supplied with DVD burner). The copied DVD disc can also be played back.

- Please read the operating instructions of the DVD burner for how to use it.
- 1080/50p scenes can be copied after converting to 1080/50i picture quality or conventional normal picture quality.
- iFrame and MP4 scenes cannot be copied to disc. Copy to PC to make a backup. (→ 122)

Preparing for copying/playing back

We recommend using Panasonic DVD burner VW-BN01.

■ About discs that can be used for copying

Disc type	DVD-RAM	DVD-RW / +RW	DVD-R / DVD-R DL / +R / +R DL
Copy* ¹	○	○	○
Additional copy* ²	○	—	—
Format* ³	○	○	—

*1 Use a new disc. You can additionally copy only to a DVD-RAM. When you copy to DVD-RW, DVD-R, DVD-R DL, +RW, +R or +R DL, the disc is automatically finalised to allow playback on other devices and additional copying will not be possible.

*2 Only DVD-RAM copied with the DVD burner can additionally copy.

*3 Connect this unit and a DVD burner before formatting. If you format a used disc, you can copy on that disc. Please be aware that if a disc is formatted, then all the data recorded on the disc will be erased. (→ 115)

- We recommend using the discs that have been recommended in the operating instructions of the DVD burner. Refer to the operating instructions of the DVD burner for details about recommended discs, disc handling etc.

1 Connect the AC adaptor (supplied with DVD burner) to the DVD burner.

- You cannot supply power to the DVD burner from this unit.

2 Connect this unit to the AC adaptor and change the mode to .

3 Connect this unit to the DVD burner with the USB Connection Cable (supplied with DVD burner).

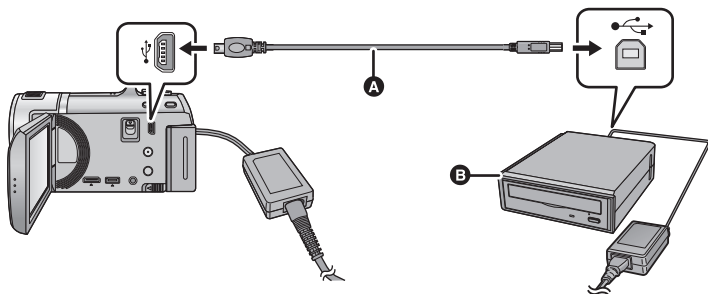

- A** USB Connection Cable (supplied with DVD burner)

- B** DVD burner (optional)

- Insert the plugs as far as they will go.

4 Insert the disc in the DVD burner.

- Insert the DVD disc with the recording side down when using the DVD burner.

5 Touch the desired item.

[BURN DISC]:

Refer to page 111 for how to copy discs.

[PLAY DISC]:

Refer to page 114 for how to play back the copied discs.



To terminate the connection with the DVD burner

Touch [EXIT].

- Disconnect the USB Connection Cable from this unit.



Copying to discs

- You cannot copy from multiple SD cards to 1 disc. (You can additionally copy only to a DVD-RAM.)
- You cannot copy motion pictures together with still pictures or motion pictures in a different picture quality (AVCHD picture quality and conventional normal picture quality) to the same disc.
- iFrame and MP4 scenes cannot be copied to disc. Copy to PC to make a backup. (→ 122)
- For copying a 3D image, refer to page 120.
- **HC-V700M**
When copying a scene in the built-in memory to the disc that includes a scene that was relay-recorded, the continued scene that is on the SD card will be copied together to the disc.

1 Connect this unit to the DVD burner to prepare for copying. (→ 109)

2 Touch [BURN DISC].

3 Touch the desired items following the instructions on the screen.

- It will return to the previous step by touching .
- (When [SELECT SCENES] is selected)
When touched, the scene/still picture is selected and the  indication appears on the thumbnail. Touch the scene/still picture again to cancel the operation.
- (When [SELECT DATE] is selected)
When touched, the date is selected and surrounded by red. Touch the date again to cancel the operation.
- Up to 99 scenes/99 dates can be selected in succession.

4 Touch [START].

- When 2 or more discs are necessary for copying, follow the on-screen instructions to switch discs.
- You may need more discs than displayed number of discs when you are copying additionally to a used DVD-RAM.
- Eject the disc after copying is completed.
- When the copied disc is played back on another device and the list of scenes is displayed, they are ordered by date.
- To create same disc again, touch [YES] and repeat step 4.

■ About recording formats when copying motion pictures

[High Definition]:

The scenes recorded in 1080/50p by this unit will be copied after converting to 1080/50i picture quality.

- When copying scenes recorded in 1080/50p, select the recording picture quality ([HA]/[HG]/[HX]/[HE]).

The scenes recorded in 1080/50i format will be copied as high definition picture quality as recorded.

[Standard] ([XP]/[SP]):

Images are converted into the original standard picture quality and then copied.

- Since [XP] has a higher picture quality compared to [SP], the data capacity becomes large so that you may need more discs for copying than [SP].

Before you delete the data on the media after copying is complete, be sure to play back the discs to check that they have been copied to correctly. (→ 114)

Important Notice

- When connecting an optional DVD burner and this unit for copying a disc, do not insert a disc with recorded motion pictures in high definition picture quality into devices that do not support the AVCHD format. In some cases the disc may get stuck in the device. The disc will not play back on devices that do not support the AVCHD format.
- When inserting a disc containing recorded motion/still pictures into other devices, a message prompting you to format the disc may be displayed. Do not format the disc, since deleted data cannot be restored later.

Approximate time for copying to a disc

To copy motion pictures to the full capacity of a disc

Disc type	Copy time		
	[High Definition]	[Standard] ([XP])	[Standard] ([SP])
DVD-RAM	Approx. 50 min to 1 h 20 min	Approx. 1 h to 1 h 30 min	Approx. 2 h to 3 h
DVD-RW ⁺ / +RW ⁺	Approx. 35 min to 1 h 15 min		
DVD-R ⁺ /+R ⁺	Approx. 15 min to 45 min		

* Even if the data capacity to be copied is small, the time it takes for copying may be about the same as the time shown in the table.

- When copying motion pictures in standard picture quality to a disc, the recordable time of [Standard] ([XP]) is approx. 1 hour and that of [Standard] ([SP]) is approx. 2 hours.

To copy approx. 600 MB still pictures (Picture size )

Disc type	Copy time
DVD-RAM/DVD-RW/DVD-R/+RW/+R	Approx. 10 min to 30 min

To copy approx. 30 minutes of motion pictures recorded in 1080/50p converted to [High Definition]/[Standard]

Disc type	Copy time
DVD-RAM/DVD-RW/DVD-R/+RW/+R	Approx. 30 min to 1 h 15 min

- Copy time of DVD-R DL/+R DL is approximately 2 to 3 times that of DVD-R/+R.
- Depending on the following conditions or discs, the time it takes for copying may be longer than the above times. Wait until the end of copying is displayed.
 - When the number of recorded scenes is large
 - When the temperature of the DVD burner has become high

-
- **The disc that was copied to can be played back by connecting this unit and a DVD burner.**
 - Do not turn off this unit or the DVD burner or disconnect the USB Connection Cable while copying. Also, do not shake this unit or the DVD burner.
 - It is impossible to stop copying halfway.
 - The order in which the scenes were copied cannot be changed.
 - Data that has been recorded on another device may not be copied.
 - When 2 or more discs are necessary for copying, the last scene copied to a disc is automatically divided to fit the space on the disc.
 - Copying may complete with more or less than the number of discs displayed when dividing of scenes was performed automatically etc.
 - For discs being copied using [Standard] ([XP])/[Standard] ([SP]), you cannot select Highlight Playback and [HIGHLIGHT] or [FACE] of Highlight & Time Frame Index.
 - The remaining copy time displayed while copying is the approximate time for a single disc.

Playing back the copied disc

- **Only discs that have been copied by connecting this unit to the DVD burner or created with HD Writer AE 4.0 can be played back.**

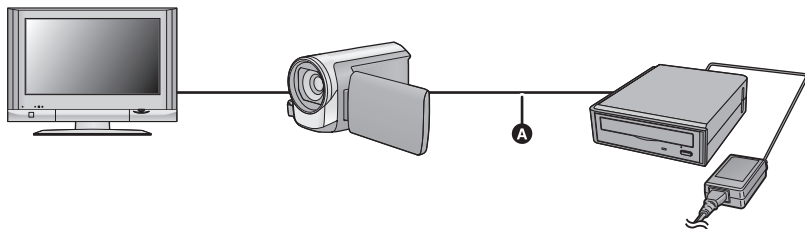

- **A** USB Connection Cable (supplied with DVD burner)

1 Connect this unit to the DVD burner to prepare for playback. (→ 109)

- When playing back on a TV, connect this unit to the TV. (→ 97)

2 Touch the scene or still picture to be played back and then play it back.

- The playback operation is performed the same as when playing back motion pictures or still pictures. (→ 27, 76)
- It will return to Step 5 on page 110 when  is selected in the thumbnail screen.

-
- It is also possible to switch the media to play back by touching the play mode select icon. When the DVD burner is connected, the disc icon can be selected from the displayed media types. (The still picture or the motion picture can be selected on the same screen.)

Managing the copied disc

- Connect this unit to the DVD burner and then touch [PLAY DISC]. (→ 110)

■ Formatting discs

This is for initialising DVD-RAM, DVD-RW and +RW discs.

Please be aware that if a disc is formatted, then all the data recorded on the disc will be erased. Back up important data on a PC etc.

 : [DISC SETUP] → [FORMAT DISC]

- When formatting is complete, touch [EXIT] to exit the message screen.
-

- Connect this unit and the DVD burner to format discs.

You may no longer be able to use the discs if you format them on another device such as a PC etc.

■ Auto protect

You can protect (write protect) a DVD-RAM disc when copying motion pictures in high definition picture quality or DVD-RW disc when copying motion pictures in high definition picture quality or still pictures to the disc.

1 Select the menu.

 : [DISC SETUP] → [AUTO PROTECT] → [ON]

- If a disc that you copied to is inserted in another device without protecting it, a message may be displayed prompting you to format the disc. We recommend setting [AUTO PROTECT] to [ON] in order to prevent accidental deletion.

2 Copy to the disc. (→ 111)

- After copying, the disc is write protected.

To release the disc protection

 : [DISC SETUP] → [CANCEL PROTECT]

- Touch [EXIT] and close the message screen after the auto protection is released.

■ Displaying disc information

Information such as the type of recorded disc, the number of recorded scenes and whether or not the disc is finalised is displayed.



 : [DISC SETUP] → [DISC STATUS]

- Touch [EXIT] to exit the information screen.

Dubbing with a Blu-ray disc recorder, video device, etc.

■ Check before dubbing

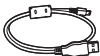
Check the equipment used for dubbing.

Equipment used for dubbing	Dubbing picture quality	To dub
Equipment with SD card slot	High-definition picture quality*	Insert the SD card directly (→ 117) 
Equipment with USB terminal	High-definition picture quality*	Connect with supplied USB cable (→ 117) 
Equipment without SD card slot or USB terminal	Standard picture quality This can be played back on equipment not compatible with high-definition (AVCHD), so is convenient if you are dubbing for distribution.	Connect with supplied AV multi cable (→ 119) 

* Some equipment may not be compatible with high-definition (AVCHD) picture quality. In such a case, connect with the AV multi cable and dub with standard picture quality. (→ 119)

- For the positions of the SD card slot, USB terminal, or terminal for connecting the AV multi cable, refer to the operating instructions of the equipment used.
- The iFrame and MP4 scenes cannot be dubbed by inserting the SD cards or by connecting with the USB cable. To dub iFrame and MP4 scenes, refer to page 119.



You can dub using a Panasonic Blu-ray disc recorder or high-definition (AVCHD) compatible DVD recorder.

- Depending on the recorders or the media to be copied to, you may not be able to copy in high-definition (AVCHD) picture quality. For further details, see the operating instructions of your recorder.
- Note that the equipment described may not be available in certain countries and regions.

About dubbing of scenes recorded in 1080/50p

The scenes recorded in 1080/50p recording mode can only be dubbed to a Blu-ray disc using the AVCHD Progressive compatible devices. The scenes recorded in 1080/50p recording mode are not displayed when connected to the product that is not compatible with AVCHD Progressive.

■ To dub using equipment with an SD card slot

You can dub by directly inserting an SD card.

● HC-V700M

To copy scenes or still pictures from the built-in memory to an SD card, see page 106.

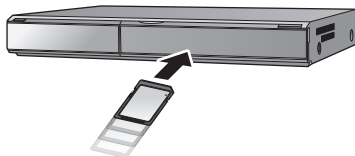

■ To dub using equipment with a USB terminal

You can dub by connecting a USB cable.

- Use the AC adaptor to free you from worrying about the battery running down.
- Turn on the unit (This function is available in all modes).

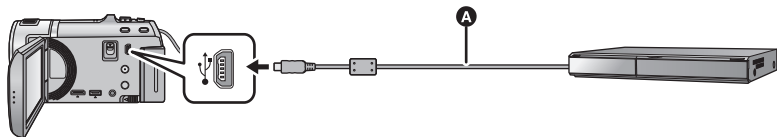

● A USB cable (supplied)

- Insert the plugs as far as they will go.

1 Connect the unit to the Blu-ray disc recorder or high-definition (AVCHD) compatible DVD recorder.

- The USB function selection screen will appear on the screen of the unit.

2 Touch [RECORDER] on the screen of this unit.

- When you select an option other than [RECORDER], reconnect the USB cable.
- **HC-V700**

When using the battery, the LCD monitor turns off after about 5 seconds. Touch the screen to turn the LCD monitor on.

3 **HC-V700M**

Touch the media you wish to dub.



- When using the battery, the LCD monitor turns off after about 5 seconds. Touch the screen to turn the LCD monitor on.

4 Dubbing through operations on the Blu-ray disc recorder or high-definition (AVCHD) compatible DVD recorder.

HC-V700M

Do not touch [CHANGE MEDIA] on the screen of the unit during dubbing.

About the screen indication of the unit

- When the unit is accessing the SD card, card access icon () appears on the unit screen or the access lamp is on.
- **HC-V700M**
When the unit is accessing the built-in memory, built-in memory access icon () appears on the unit screen or the access lamp is on.
- Be careful not to disconnect the USB cable, AC adaptor or battery while the unit is accessing the media, as this may result in the loss of recorded content.

-
- Do not use any other USB cables except the supplied one. (Operation is not guaranteed with any other USB cables.)
 - When this unit is connected to a Panasonic Blu-ray disc recorder or a DVD recorder using a USB cable while the unit is turned on, power is also supplied from the connected equipment to this unit.
 - For details on dubbing and playback methods, read the operating instructions of the Blu-ray disc recorder or DVD recorder.
 - When you connect the unit to a Blu-ray disc recorder, a dubbing operations screen may appear on the television connected to the Blu-ray disc recorder. In this case as well, perform the operations of Steps 1 to 4.
 - You cannot change the mode of the unit or turn off the unit while it is connected to a Blu-ray disc recorder or DVD recorder. Disconnect the USB cable before performing either of these operations.
 - If the battery runs down during dubbing, a message will appear. Operate the Blu-ray disc recorder to cancel the dubbing.



■ Dubbing using equipment without an SD card slot or a USB terminal, or using a video device

You can dub by connecting an AV multi cable.

- **Images are dubbed in standard quality.**
- Use the AC adaptor to free you from worrying about the battery running down.

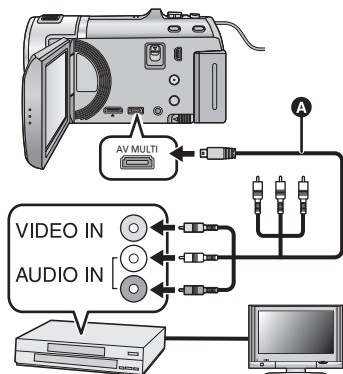

Change the video input on the video device and TV that this unit is connected to.

- The channel set will differ depending on the terminal to which the unit is connected.
 - See the operating instructions of the video device for details.
 - Insert the plugs as far as they will go.
 - Do not use any other AV multi cables except the supplied one.
- A** AV multi cable (supplied)

- Change the mode to .

1 Connect this unit to a video device and start playback on this unit.

2 Start recording on the connected device.

- To stop recording (dubbing), stop playback on this unit after stopping recording on the recorder.

-
- If the date and time display and function indication are not wanted, cancel them before dubbing. (→ 32, 99)
 - For setting when connecting the AV multi cable, refer to page 100.

If the dubbed images are played back on a wide-screen TV, the images may be stretched vertically.

In this case, refer to the operating instruction for the device you are connecting to or read the operating instructions of the wide-screen TV and set the aspect ratio to 16:9.

3D image storage



You can store 3D image with a DVD burner, video device or a PC.

Copying with a DVD burner

- Please refer to page 109 for details about copying with a DVD burner.

■ Copying unaltered as 3D image

Recording format: [High Definition]

The scenes recorded in 3D using the unit can be copied and stored in unaltered form as 3D video. The video is recorded unaltered in side-by-side format.

■ Copying after conversion to 2D image

Recording format: [Standard] ([XP]/[SP])

Scenes recorded in 3D are converted to 2D motion picture before being copied and stored. In this case, 3D motion picture cannot be stored in unaltered form.

- Recording quality cannot be selected for copying still pictures.

Dubbing with a Blu-ray disc recorder, video device, etc.

■ Dubbing in high-definition picture quality (Dubbing directly from inserted SD card/Dubbing with a USB cable)

- Please refer to page 116 for details about dubbing in high-definition picture quality

When dubbing with high-definition (AVCHD) picture quality, you can store 3D motion picture. The video is recorded unaltered in side-by-side format.

- If the dubbed motion picture does not change to 3D motion picture, make the necessary settings on the TV. (For further details, please read the operating instructions for the TV.)
- It may not be possible to copy 3D still pictures (MPO format) depending on the recorder being used.

■ Dubbing in standard picture quality

- Please refer to page 119 for details about dubbing in standard picture quality.

Copying unaltered as 3D motion picture

When [3D PLAYBACK] is [AUTO], the 3D motion picture is recorded in side-by-side format.

: [SETUP] → [3D PLAYBACK] → [AUTO]

- If the dubbed motion picture does not change to 3D motion picture, make the necessary settings on the TV. (For further details, please read the operating instructions for the TV.)

Copying after conversion to 2D motion picture

Set [3D PLAYBACK] to [2D].

MENU : [SETUP] → [3D PLAYBACK] → [2D]

- Set [CONV. 2D TO 3D] to [OFF]. (→ 104)

Copying between SD card and built-in memory [HC-V700M]

- Please refer to page 106 for details about copying between SD card and built-in memory.

■ Copying scenes recorded in 3D

MENU : [COPY] → [ → ] or [ → ]

- You can copy scenes recorded in 3D between the SD card and the built-in memory.
 - Select [VIDEO] → [SELECT SCENES] or [SELECT DATE] → [SbS 3D].
 - When selecting scenes, select ones marked with **3D** on the thumbnail display.
 - When selecting by date, select a date marked with **3D** from the list of dates.

Using HD Writer AE 4.0

- Please refer to page 122 for details about copying with HD Writer AE 4.0. When you use HD Writer AE 4.0 to handle scenes recorded in 3D, the following operations are possible.

- Copying data to a PC
(Scenes recorded in 3D will be copied unaltered as 3D motion picture.)
- Copying in Blu-ray disc/AVCHD format
(Scenes recorded in 3D will be copied unaltered as 3D motion picture.)
- Copying in DVD-Video format
(Scenes recorded in 3D will be converted to 2D motion picture when copied.)
- Editing
- Online sharing
(Convert the scenes recorded in 3D to 2D motion picture when uploading.)
- Playing back on a PC

Using a Mac

- Scenes recorded in 3D are not supported by iMovie'11.

What you can do with a PC

HD Writer AE 4.0

You can copy the motion/still picture data to the HDD of PCs or write to media like Blu-ray discs, DVD discs or SD cards using HD Writer AE 4.0, the software installed in the supplied CD-ROM.

Refer to the operating instructions of HD Writer AE 4.0 (PDF file) for details on how to use it.

■ Smart Wizard

The Smart Wizard Screen is automatically displayed when you connect this unit to a PC with HD Writer AE 4.0 installed. (→ 131)



Copy to PC:

You can copy motion/still picture data to the HDD of PCs.

Copy to disc:

You can copy to disc in high definition picture quality or conventional standard picture quality (MPEG2 format).

- Select the function you wish to use and follow the on-screen instructions for easy copying.

What can be done with the HD Writer AE 4.0	Data type
Copying data to a PC	Motion picture and still picture
Copying in Blu-ray disc/AVCHD format: <ul style="list-style-type: none"> ● The scenes recorded in 1080/50p can be copied as 1080/50p. (Important Notice → 124) ● The scenes recorded in iFrame or the scenes saved as MP4 cannot be copied in Blu-ray disc or in AVCHD format. 	
Copying in DVD-Video format: <ul style="list-style-type: none"> ● Converted to conventional standard quality (MPEG2 format). 	Motion picture
Editing: Editing motion picture data copied on an HDD of a PC <ul style="list-style-type: none"> ● Dividing, Trimming, Still picture, Title, Effect, Transition, BGM, Delete partially ● Converting the motion picture data to MPEG2 ● Converting part of motion picture into still picture 	
Online sharing: You can upload motion pictures on the Internet and share them with your family and friends.	
Playing back on a PC: Play back the motion picture data in high definition picture quality on a PC.	Motion picture and still picture
Formatting discs: Depending on the type of disc that you use, formatting is necessary.	Motion picture

- It is possible to play back still pictures on a PC using an image viewer standard to Windows or commercially available image browsing software, and copy still pictures to a PC using Windows Explorer.
- Please refer to page 135 for details about using a Mac.

Important Notice

- When using an SDXC Memory Card, check the following support site.
<http://panasonic.net/avc/sdcard/information/SDXC.html>
- Do not insert a disc recorded in AVCHD format with HD Writer AE 4.0 in a device that does not support the AVCHD format. In some cases the disc may get stuck in the device. The disc will not play back on devices that do not support the AVCHD format.
- To play back a Blu-ray disc to which you have copied scenes recorded in 1080/50p, equipment is required that supports AVCHD Progressive.
- When inserting a disc containing recorded motion pictures into other devices, a message prompting you to format the disc may be displayed. Do not format the disc, since deleted data cannot be restored later.

- Data cannot be written into the SD card from a PC via this unit.
- **HC-V700M**
It is impossible to write data to the built-in memory on this unit from a PC.
- Motion pictures that have been recorded on another device cannot be written to the software supplied with this unit. To write motion picture data recorded with the Panasonic High Definition Video Camera sold previously, use the HD Writer supplied with the unit.
- When motion picture data is written to and read from the SD card, correct operation of the unit cannot be guaranteed if software other than that supplied with the unit is used.
- Do not start the software supplied with this unit and other software at the same time. Close any other software if you start the software supplied with this unit and close the software supplied with this unit if you start any other software.

■ About Conversion Assist Function

When you want to convert the recording quality and write to media, the "Conversion Assist Function", which is a linking function between this unit and the HD Writer AE 4.0, is activated by connecting this unit to the PC with the USB cable. When the "Conversion Assist Function" is used, it is possible to write to media faster than when operating only on PC.

- Please refer to page 131 about the connection of this unit and a PC.
- Refer to the operating instructions of the software for details. (→ 134)

End User License Agreement

Before opening the CD-ROM package, please read the following.

You ("Licensee") are granted a license for the Software defined in this End User License Agreement ("Agreement") on condition that you agree to the terms and conditions of this Agreement.

Article 1 License

Licensee is granted the right to use the software, including the information recorded or described on the CD-ROM, instruction manuals, and any other media provided to Licensee (collectively "Software"), but all applicable rights to patents, copyrights, trademarks and trade secrets in the Software are not transferred to Licensee.

Article 2 Use by a Third Party

Licensee may not use, copy, modify, transfer, rent, lease, lend or allow any third party, whether free of charge or not, to use, copy or modify the Software, except as expressly provided for in this Agreement.

Article 3 Restrictions on Copying the Software

Licensee may make a single copy of the Software in whole or a part solely for back-up purpose.

Article 4 Computer

Licensee may use the Software only on one computer, and may not use it on more than one computer. Further, Licensee may not use the Software for commercial software hosting services.

Article 5 Reverse Engineering, Decompiling or Disassembly

Licensee may not reverse engineer, decompile, or disassemble the Software, except to the extent either of them is permitted under law or regulation of the country where Licensee resides. Panasonic, or its distributors will not be responsible for any defects in the Software or damage to Licensee caused by Licensee's reverse engineering, decompiling, or disassembly of the Software.

Article 6 Indemnification

The Software is provided "AS-IS" without warranty of any kind, either expressed or implied, including, but not limited to, warranties of non-infringement, merchantability and/or fitness for a particular purpose. Further, Panasonic does not warrant that the operation of the Software will be uninterrupted or error free. Panasonic or any of its distributors will not be liable for any damage suffered by Licensee arising from or in connection with Licensee's use of the Software.

Article 7 Export Control

Licensee agrees not to export or re-export to any country the Software in any form without the appropriate export licenses under regulations of the country where Licensee resides, if necessary.

Article 8 Termination of License

The right granted to Licensee hereunder will be automatically terminated if Licensee contravenes any of the terms and conditions of this Agreement. In this event, Licensee must destroy the Software and related documentation together with all the copies thereof at Licensee's own expense.

Article 9 With regard to MICROSOFT SQL SERVER COMPACT 3.5 produced by Microsoft Corporation

(1) Licensee shall use the MICROSOFT SQL SERVER COMPACT 3.5 only when included in the Software, and shall not use the MICROSOFT SQL SERVER COMPACT 3.5 in any other configuration or method. Licensee shall not publish the MICROSOFT SQL SERVER COMPACT 3.5 or work around any technical limitations in the MICROSOFT SQL SERVER COMPACT 3.5.

(2) Licensee shall not use, copy, distribute, regrant for use or otherwise handle the Software in any way beyond the range of use granted under Article 9 (1), and shall not conduct operations such as reverse engineering, decompilation, disassembling, etc. of the MICROSOFT SQL SERVER COMPACT 3.5.

(3) All rights, including copyright, patent rights etc. relating to the MICROSOFT SQL SERVER COMPACT 3.5 shall belong to Microsoft Corporation. Licensee shall not claim any rights related to the MICROSOFT SQL SERVER COMPACT 3.5 whatsoever.

Operating environment

- Even if the system requirements mentioned in these operating instructions are fulfilled, some PCs cannot be used.
- A CD-ROM drive is necessary to install the supplied software applications. (A compatible Blu-ray disc/DVD writer drive and media are necessary for writing to a Blu-ray disc/DVD.)
- Operation is not guaranteed in the following cases.
 - When 2 or more USB devices are connected to a PC, or when devices are connected through USB hubs or by using extension cables.
 - Operation on an upgraded OS.
 - Operation on an OS other than the one pre-installed.
- This software is not compatible with Microsoft Windows 3.1, Windows 95, Windows 98, Windows 98SE, Windows Me, Windows NT and Windows 2000.

■ Operating environment for HD Writer AE 4.0

PC	IBM PC/AT compatible PC
OS	Windows 7 (32 bit/64 bit) Starter/Home Basic/Home Premium/Professional/Ultimate (SP1) Windows Vista (32 bit) Home Basic/Home Premium/Business/Ultimate (SP2) Windows XP (32 bit) (SP3)
CPU	Intel Pentium 4 2.8 GHz or higher (including compatible CPU) <ul style="list-style-type: none"> ● Intel Core 2 Duo 2.16 GHz or higher or AMD Athlon 64 X2 Dual-Core 5200+ or higher is recommended when using playback function or MPEG2 output function. ● Intel Core 2 Quad 2.6 GHz or higher is recommended when using the editing or Continuous Photo Playback function. ● Intel Core i7 2.8 GHz or higher is recommended when playing back or using the editing function for 1080/50p
RAM	Windows 7: 1 GB or more (32 bit)/2 GB or more (64 bit) Windows Vista: 1 GB or more Windows XP: 512 MB or more (1 GB or more recommended)
Display	High Colour (16 bit) or more (32 bit or more recommended) Desktop resolution of 1024×768 pixels or more (1920×1080 pixels or more recommended) Windows 7/Windows Vista: DirectX 9.0c compatible video card (DirectX 10 recommended) Windows XP: DirectX 9.0c compatible video card Compatible with DirectDraw overlay PCI Express™ ×16 compatible recommended Video memory of 256 MB or more recommended

Free hard disk drive space	Ultra DMA — 100 or more 450 MB or more (for installing the software) <ul style="list-style-type: none"> When writing to a DVD/Blu-ray disc/SD, more than double the amount of free space as the disc being created is necessary.
Sound	DirectSound Support
Interface	USB port [Hi-Speed USB (USB 2.0)]
Other requirements	Mouse or equivalent pointing device Internet connection

■ When using the 3D watching function

OS	Windows 7 (32 bit/64 bit) Home Premium/Professional/Ultimate or SP1
CPU	Intel Core 2 Quad 2.8 GHz or higher is recommended.
Display	3D VISION-Ready Display
Graphics Card	3D VISION Compatible NVIDIA Graphics Card*
3D glasses	NVIDIA 3D VISION Kit*

* Make sure that you are using the latest version of a video card driver.

- Supplied CD-ROM is available for Windows only.
- Input is not supported in languages other than English, German, French, Simplified Chinese and Russian.
- Operation cannot be guaranteed on all Blu-ray disc/DVD drives.
- Operation is not guaranteed on Microsoft Windows Vista Enterprise, Windows XP Media Center Edition, Tablet PC Edition and Windows 7 Enterprise.
- This software is not compatible with a multi-boot environment.
- This software is not compatible with a multi-monitor environment.
- If using Windows XP, an administrative account user only can use this software. If using Windows Vista/Windows 7, administrative account and standard account users only can use this software. (An administrative account user should install and uninstall this software.)

■ To use the HD Writer AE 4.0

You will need a high performance PC depending on the functions to be used. It may not properly play back or properly operate depending on the environment of the PC used. Refer to the operating environment and notes.

- Operation during the playback may become slow if the CPU or memory is not fulfilling the requirements of the operating environment.
- Always use the most current driver for the video card.
- Always make sure there is enough capacity on the HDD in the PC. It may become inoperable or the operation may stop suddenly if the capacity gets low.

■ Operating environment for the card reader function (mass storage)

PC	IBM PC/AT compatible PC
OS	Windows 7 (32 bit/64 bit) or SP1 Windows Vista (32 bit) (SP2) Windows XP (32 bit) (SP3)
CPU	Windows 7/Windows Vista: 1 GHz or higher 32-bit (×86) or 64-bit (×64) processor (including compatible CPU) Windows XP: Intel Pentium III 450 MHz or higher or Intel Celeron 400 MHz or higher
RAM	Windows 7: 1 GB or more (32 bit)/2 GB or more (64 bit) Windows Vista Home Basic: 512 MB or more Windows Vista Home Premium/Business/Ultimate/Enterprise: 1 GB or more Windows XP: 512 MB or more (1 GB or more recommended)
Interface	USB port
Other requirements	Mouse or equivalent pointing device

- The USB equipment operates with the driver installed as standard in the OS.

Installation

When installing the software, log on to your computer as the Administrator or with a user name with equivalent authorization. (If you do not have authorization to do this, consult your manager.)

- Before starting the installation, close all applications that are running.
- Do not perform any other operations on your PC while the software is being installed.
- Explanation of operations and screens is based on Windows 7.

1 Insert the CD-ROM into the PC.

- The following screen is displayed automatically. Click [Run setup.exe] → [Yes].
- If Windows 7 is in use, or the following screen is not displayed automatically, select [Start] → [Computer] (or double-click on [Computer] on the desktop), and then double-click [Panasonic].

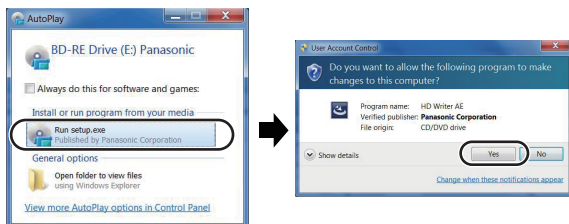

2 Click [Yes].

- Operate following the instruction on the screen.
- If the country or region cannot be selected, select [PAL Area].

The PC must be rebooted for the application to work.

■ Uninstalling HD Writer AE 4.0

Follow the steps below to uninstall all software applications that you no longer require.

1 Select [Start] → [Control Panel] → [Uninstall a program].

2 Select [HD Writer AE 4.0], then click [Uninstall].

- Proceed with the uninstallation by following the on-screen instructions.
- After uninstalling the software, be sure to reboot the PC.

Connecting to a PC

- Connect this unit to the PC after the software applications are installed.
- Remove the supplied CD-ROM from your PC.

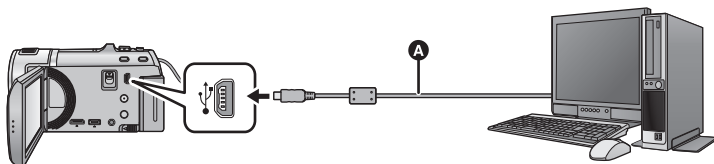

- A** USB cable (supplied)
- Insert the plugs as far as they will go.

1 Connect this unit to the AC adaptor.

- Use the AC adaptor to free you from worrying about the battery running down.
- Connect with the AC adaptor when using the Conversion Assist Function.

2 Turn on the unit.

- This function is available in all modes.

3 Connect this unit to a PC.

- The USB function selection screen will appear.

4 Touch [PC] on the screen of this unit.

- The Smart Wizard Screen is automatically displayed when HD Writer AE 4.0 is installed.
- This unit is automatically recognised as an external drive of the PC. (→ 133)
- When you select an option other than [PC], reconnect the USB cable.
- When using the battery, the LCD monitor turns off after about 5 seconds. Touch the screen to turn the LCD monitor on.



-
- Do not use any other USB cables except the supplied one. (Operation is not guaranteed with any other USB cables.)
 - When this unit is connected to a PC using a USB cable while the unit is turned on, power is also supplied from the PC to this unit.
 - When performing reading/writing between a PC and an SD card, be aware that some SD card slots built into PCs and some SD card readers are not compatible with the SDHC Memory Card or SDXC Memory Card.
 - When using an SDXC Memory Card, check the following support site.
<http://panasonic.net/avc/sdcard/information/SDXC.html>

■ To disconnect USB cable safely

Select the  icon in task tray displayed on the PC, and then click [Eject Panasonic Camcorder].

- Depending on your PC's settings, this icon may not be displayed.

About the screen indication of the unit

- Do not disconnect the USB cable, battery, or AC adaptor while the access lamp is on or card access icon () appears on the unit screen.
- **HC-V700M**
Do not disconnect the USB cable, battery, or AC adaptor while the access lamp is on or built-in memory access icon () appears on the unit screen.
- If the screen does not change when the unit is operated while connected to a PC, disconnect the battery and/or AC adaptor, wait approximately 1 minute, reconnect the battery and/or AC adaptor, wait approximately 1 minute again, and then turn the unit back on. (Data may be destroyed when above operation is performed while accessing the SD card or built-in memory.)

■ Charging the battery by connecting it to different devices

When using the battery, if you turn off the unit and connect it to a PC, Panasonic Blu-ray disc recorder or Panasonic DVD recorder, the battery will charge.

- **When connecting this unit to a PC for the first time, make sure to connect this unit to the PC with this unit turned on.**
- Insert the USB cable securely all the way. It will not operate properly if it is not inserted all the way.
- Do not use any other USB cables except the supplied one. (Operation is not guaranteed with any other USB cables.)
- Be sure to connect the unit directly to the PC, Blu-ray disc recorder or DVD recorder.
- During charging, the status indicator flashes.
- You cannot charge when the status indicator flashes rapidly, or when it does not light at all. Charge using the AC adaptor. (→ 10)
- It will take 2 or 3 times longer to charge compared to when using the AC adaptor.
- If the status indicator flashes at a particularly fast or slow rate, refer to page 150.

About the PC display

When the unit is connected to a PC, it is recognised as an external drive.

- Removable disk (Example:  CAM_SD (F:)) is displayed in [Computer].

We recommend using HD Writer AE 4.0 to copy motion picture data.

Using Windows Explorer or other programmes on the PC to copy, move or rename files and folders recorded with this unit will result in them being unusable with HD Writer AE 4.0.

It is impossible to write data to the built-in memory or SD card on the unit from a PC.

Example folder structure of an SD card:

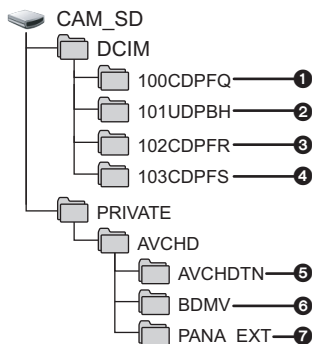

HC-V700M

Example folder structure of built-in memory:

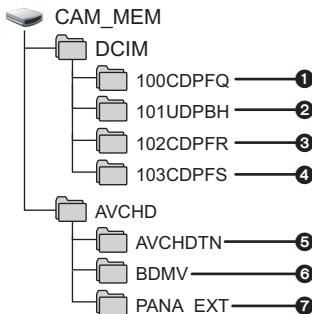

The following data will be recorded.

- ① **MPO/JPEG format still pictures (up to 999 still pictures can be recorded. ([S1000001.MPO], [S1000001.JPG], etc.))**
- ② **iFrame/MP4 format motion picture files ([S1000001.MP4] etc.)**
- ③ **JPEG format still pictures recorded in Hi-Speed Burst Shooting Mode**
- ④ **MPO/JPEG format still pictures created from the motion picture**
- ⑤ **The motion picture thumbnails**
- ⑥ **AVCHD format motion picture files ([00000.MTS] etc.)**
- ⑦ **For management**

■ Copying your still pictures to your PC

Card reader function (mass storage)

Still pictures recorded with this unit can be copied to the PC with Explorer or other programmes.

- 1 **Double click the folder that contains the still pictures. ([DCIM] → [100CDPFQ] etc.)**
- 2 **Drag and drop the still pictures onto the destination folder (on the PC's HDD).**

- Do not delete the SD card's folders. Doing so may make the SD card unusable in this unit.
- When data not supported by this unit has been recorded on a PC, it will not be recognised by this unit.
- Always use this unit to format SD cards.

Starting HD Writer AE 4.0

- To use the software, log on as an Administrator or as user name for standard user account (only for Windows 7/Windows Vista).
The software cannot be used with the user name for a guest account.

(On the PC)

Select [Start] → [All Programs] → [Panasonic] → [HD Writer AE 4.0] → [HD Writer AE].

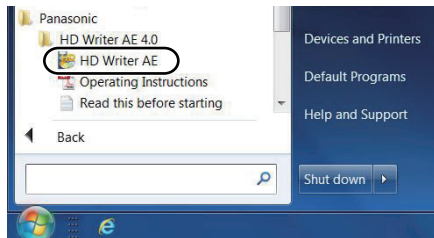



- For details on how to use the software applications, read the PDF operating instructions of the software.

Reading the operating instructions of the software applications

- You will need Adobe Acrobat Reader 5.0 or later or Adobe Reader 7.0 or later to read the PDF operating instructions.

Select [Start] → [All Programs] → [Panasonic] → [HD Writer AE 4.0] → [Operating Instructions].

If using Mac

- HD Writer AE 4.0 is not available for Mac.
- iMovie'11 supported. For details about iMovie'11, please contact Apple Inc.
- iMovie'11 is not compatible with 1080/50p. 1080/50p scenes cannot be imported to a Mac.
 - For users who have [HC-V700], it cannot acquire the scenes recorded in 1080/50p. Record in normal recording mode when importing to Mac.
 - For users who have [HC-V700M], convert the scene with [1080/50p]   before importing. (→ 106)

■ Operating environment

PC	Mac
OS	Mac OS X 10.7.2
CPU	Intel Core 2 Duo or better
RAM	2 GB or more
Interface	USB port
Other requirements	Mouse or equivalent pointing device

- Even if the system requirements mentioned in these operating instructions are fulfilled, some PCs cannot be used.
- The USB equipment operates with the driver installed as standard in the OS.
- Supplied CD-ROM is available for Windows only.

■ Copying still pictures on PC

1 Connect this unit to a PC via the supplied USB cable.

- The USB function selection screen will appear.

2 Touch [PC] on the screen of this unit.

- This unit is automatically recognised as an external drive of Mac.
- When you select an option other than [PC], reconnect the USB cable.
- When using the battery, the LCD monitor turns off after about 5 seconds. Touch the screen to turn the LCD monitor on.

3 Double-click [CAM_SD] displayed on the desktop.

- For users who have [HC-V700M], [CAM_SD] and [CAM_MEM] are displayed on the desktop.
- Files are stored in [100CDPFQ] or [102CDPFR] folder etc. in the [DCIM] folder.

4 Using a drag-and-drop operation, move the pictures you want to acquire or the folder storing those pictures to any different folder on the PC.

■ To disconnect USB cable safely

Drag [CAM_SD] disk icon to the [Trash], and then disconnect the USB cable.

- For users who have **HC-V700M**, [CAM_SD] and [CAM_MEM] are displayed on the desktop.
-

- The still picture of MPO format is not compatible with Mac.

Indications

* **HC-V700M** only

■ Recording indications

Motion Picture Recording Mode

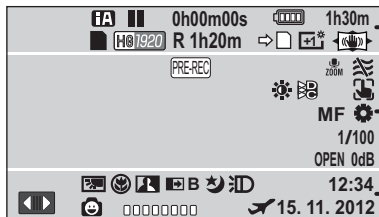

Still Picture Recording Mode

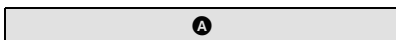
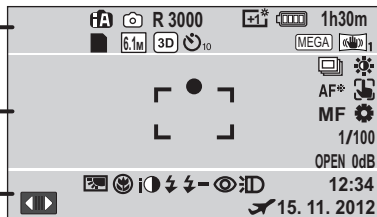

Intelligent Auto Mode (→ 25)

MNL Manual Mode (→ 69)

Scene Mode (→ 54)

3D 3D recording (→ 74)

●/II (Red) Recording

II (Green) Recording pause

0h00m00s Elapsed recording time (→ 20)

("h" is an abbreviation for hour, "m" for minute and "s" for second.)

Remaining battery power (→ 11)

1h30m Remaining battery time (→ 11)

Built-in memory recording possible status*

(White) Card recording possible status

 (Green) Recognising the card

1080/50p / HA1920 / H01920 / HX1920 / HE1920 /

i Frame / Sbs 3D

Motion Picture Recording Mode (→ 56)

R 1h20m Remaining time for motion picture recording (→ 20)

Relay Recording (→ 56)*

A* / **+2*** / **+1*** / **-1***

Power LCD (→ 35)



Image Stabilizer (→ 42, 75)/Optical Image Stabilizer Lock (→ 46, 75)

(White) Still picture recording icon

 (Red) Recording still picture

R3000 Remaining number of still pictures (→ 23)

























6.1m / 2.3m / 0.3m / 6.1m / 2.3m / 5.8m / 2.1m / 0.2m























Number of recording pixels for still pictures (→ 23, 65, 67, 77)

In Playback Mode, the picture size is not displayed for still pictures recorded with other products that have different picture sizes from the sizes shown above.

10/2 Self-Timer Recording (→ 51)

MEGA MEGA OIS (→ 22)

B	
	PRE-REC (→ 48)
	Zoom Microphone (→ 62)
	Wind Noise Canceller (→ 62)
	Picture Adjustment (→ 64)
	Digital Cinema Colour (→ 61)
	AF/AE tracking (→ 45)
	Touch Zoom (→ 44)
	Touch Shutter (→ 46)
MF	Manual Focus (→ 72)
      	White Balance (→ 70)
1/100	Shutter Speed (→ 71)
OPEN/F2.0	Iris value (→ 71)
0dB	Gain value (→ 71)
 (White) /  (Green) /      	Focus indication (→ 22)
	High-Speed Burst Shooting (→ 67)
AF*	AF assist lamp (→ 68)

C	
	Display Touch Menu (→ 16)
	Backlight Compensation (→ 51)
	Tele Macro (→ 52)
	Intelligent Contrast Control (→ 48)
□□□□□□□□	Microphone Level (→ 63)
   	Video Light (→ 53)
 	Smile Shot (→ 49)
 W /  B	Fade (White), Fade (Black) (→ 48)
	Colour Night View function (→ 53)
	Intelligent Exposure (→ 51)
  A / 	Flash (→ 50)
  	Flash Level (→ 50)
	Red-eye Reduction (→ 50)
	World time setting (→ 31)
15. 11. 2012	Date indication (→ 17)
12:34	Time indication (→ 17)

■ Playback indications



Display during playback (→ 27, 76)

0h00m00s Playback Time (→ 27)

No.10 Scene Number

Repeat Playback (→ 78)

Resume Playback (→ 79)

100-0001 Still picture folder/file name

Protected motion pictures/
still pictures (→ 94)

AVCHD / 1080/50p / 1080/50i / Sbs 3D / i Frame /
MP4

Play mode selection display (→ 27)

Relay-recorded scene
(→ 56)*

Still picture recorded using
Smile Shot (→ 49)

Scenes saved with Highlight
Playback (→ 86)

Scenes that are face
recognised (→ 94)

Scenes recorded in 3D
(→ 103)

■ Indication of connection to other devices

Accessing the card (→ 118,
132)

Accessing the built-in memory
(→ 118, 132)*

■ Confirmatory indications

-- (Time display) The built-in battery is low.
(→ 17)

Warning for recording of
yourself (→ 18)

SD card is not inserted or is
non-compatible.

■ Confirmatory indications when a DVD burner is connected

Disc Playback (→ 114)

Scene copied in [Standard]
([XP])

Scene copied in [Standard]
([SP])

Disc type (→ 109)

Messages

Major confirmation/error messages to be indicated on the screen in text.

* **HC-V700M** only

PERIODICALLY MAKE BACK UP OF DATA IN BUILT-IN MEMORY.*

We recommend backing up important recorded motion pictures and still pictures periodically to a PC, DVD disc etc. to protect it. (→ 109, 122) This message does not indicate that there is a problem with this unit.

CHECK CARD.

This card is not compatible or it cannot be recognised by the unit.
If this message appears even though motion pictures and still pictures are recorded on an SD card, the card may be unstable. Reinsert the SD card, then turn the unit off and then on again.

THIS BATTERY CANNOT BE USED.



- Use a battery that is compatible with this unit. (→ 9)
If using a Panasonic battery compatible with this unit, remove the battery and then insert it again. If the message appears even after repeating this several times, this unit needs repair. Detach the power and consult the dealer who you purchased this unit from. Do not attempt to repair it by yourself.
- You are attempting to connect an AC adaptor not compatible with this unit. Use the supplied AC adaptor. (→ 10)

PLEASE CHECK EXTERNAL DRIVE OR DISC.

A disc that cannot be used when connecting the unit to the DVD burner has been inserted, or the DVD burner is not recognised properly. Connect the USB Connection Cable again and insert a disc to copy the data. (→ 109)

About recovery



If faulty management information is found, the messages may appear and a repair is performed. (Repairing may take time depending on the error.)

-  is displayed when abnormal management information is detected when the scenes are displayed in thumbnail. **To perform the repair, touch the scene with  in the thumbnail, and start the playback.**
-

- Use a sufficiently charged battery or the AC adaptor.
- Depending on the condition of the data, it may not be possible to completely repair the data.
- If recovery fails, it will not be possible to play back scenes recorded before the unit turned off.
- When data recorded on another device is recovered, it may not be possible to play back the data on this unit or the other device.
- If recovery fails, turn the unit off and on again after waiting awhile. If recovery fails repeatedly, format a media on the unit. Please be aware that if a media is formatted, then all the data recorded on the media will be erased.
- If the thumbnail information is recovered, displaying the thumbnails may become slower.

Troubleshooting

■ It is not a malfunction in following cases

<p>A clicking sound is heard when the unit is shaken.</p>	<ul style="list-style-type: none"> ● This is the sound of the lens moving and is not a defect. This sound will no longer be heard when the unit is turned on and change the mode to  or .
<p>Object seems to be warped.</p>	<ul style="list-style-type: none"> ● Object seems to be warped slightly when the object moves across the image very fast, but this is because the unit is using MOS for the image sensor. This is not a malfunction.
<p>White round spots like soap bubbles appear on the recorded picture.</p>	<ul style="list-style-type: none"> ● If you take a picture with the flash in a dark place or indoors, white round spots may appear on the picture caused by the flash reflecting of particles of dust in the air. This is not a malfunction. A characteristic of this is that the number of round spots and their position differ in every picture. 

Power

Problem	Check points
<p>This unit cannot be turned on.</p> <p>This unit does not stay on long enough.</p> <p>Battery runs down quickly.</p>	<ul style="list-style-type: none"> ● Charge the battery again to ensure it is sufficiently charged. (→ 10) ● In cold places, the battery using time becomes shorter. ● The battery has a limited life. If the operating time is still too short even after the battery is fully charged, the battery has worn out and needs to be replaced.
<p>This unit is turned off automatically.</p>	<ul style="list-style-type: none"> ● If the unit turns off when you turn off the power to the TV using the TV remote control, the VIERA Link is at work. If you are not using the VIERA Link, set [VIERA Link] to [OFF]. (→ 101) ● When this unit is connected to a DVD burner to copy or play back images (a disc is being accessed), the unit turns off automatically if the USB Connection Cable is removed.



Power

Problem	Check points
This unit cannot be operated though it is turned on. This unit does not operate normally.	<ul style="list-style-type: none">● Remove the battery or AC adaptor, wait about 1 minute and then reconnect the battery or AC adaptor. Then about 1 minute later, turn on the unit again. (Conducting the above operation while the media is being accessed may damage the data on the media.)● If normal operation is still not restored, detach the power connected, and consult the dealer who you purchased this unit from.
“ERROR OCCURRED. PLEASE TURN UNIT OFF, THEN TURN ON AGAIN.” is displayed.	<ul style="list-style-type: none">● The unit has automatically detected an error. Restart the unit by turning off and on.● The unit will be turned off in about 1 minute if the unit is not turned off and on.● Repair is needed if it is repeatedly displayed even if it is restarted. Detach the power connected, and consult the dealer who you purchased this unit from. Do not attempt to repair the unit by yourself.



Indication

Problem	Check points
Remaining battery indication is not displayed properly.	<ul style="list-style-type: none">● The remaining battery capacity indication is an approximation. If the remaining battery capacity indication is not displayed correctly, fully charge the battery, discharge it and then charge it again.

Recording

Problem	Check points
The unit arbitrarily stops recording.	<ul style="list-style-type: none"> ● Use an SD card that can be used for motion picture recording. (→ 12) ● The recordable time may have shortened due to the deterioration of the data writing speed or repeated recording and deletion. Using the unit, format the SD card or built-in memory. (→ 37) ● If [AGS] is [ON], record in the normal horizontal position or set [AGS] to [OFF]. (→ 61)
Auto Focus function does not work.	<ul style="list-style-type: none"> ● Switch to Intelligent Auto Mode. ● If you are trying to record a scene which is hard to bring into focus in Auto Focus Mode, use the Manual Focus Mode to adjust the focus. (→ 26, 72)
Colour balance of images is strange when recording in a place such as a gymnasium.	<ul style="list-style-type: none"> ● In a place with multiple light sources, such as a gymnasium or a hall, set the White Balance setting to  (Indoor mode 2). If you cannot record clearly with the  (Indoor mode 2), set it to  (Manual adjustment mode). (→ 70)
<p>Colour or brightness of the image changes, or you may see horizontal bars in the image.</p> <p>The LCD monitor flickers indoors.</p>	<ul style="list-style-type: none"> ● Colour or brightness of the image may change, or you may see horizontal bars in the image when the object is recorded under fluorescent light, mercury light or sodium light, etc., but this is not a malfunction. ● In Motion Picture Recording Mode, record in Intelligent Auto Mode or set the shutter speed to 1/100 in areas where the power supply frequency is 50 Hz, or 1/125 in areas of 60 Hz. ● In Still Picture Recording Mode, this will not affect the recorded image.

Playback

Problem	Check points
Scenes/still pictures cannot be played back.	<ul style="list-style-type: none"> ● Any scenes/still pictures where the thumbnails are displayed as  cannot be played back.
Scenes cannot be deleted.	<ul style="list-style-type: none"> ● Release the protect setting. (→ 94) ● Any scenes/still pictures where the thumbnails are displayed as  cannot be deleted. If the scenes/still pictures are unnecessary, format the media to erase the data. (→ 37) Please be aware that if a media is formatted then all the data recorded on the media is erased and cannot be recovered. Back up important data on a PC, disc etc.

With other products

Problem	Check points
<p>Although this unit is correctly connected to a TV, images cannot be seen.</p> <p>The images are squeezed horizontally.</p>	<ul style="list-style-type: none"> ● Please read the operating instructions of your TV and select the channel that matches the input used for the connection. ● Change the [TV ASPECT] setting to match the aspect ratio of the TV. (→ 99) ● Change the setting of the unit depending on the cable connecting to the TV. (→ 100)
<p>If the SD card is inserted in another device, it is not recognised.</p>	<ul style="list-style-type: none"> ● Check that the device is compatible with the capacity or type of SD card (SD Memory Card/SDHC Memory Card/SDXC Memory Card) that you inserted. Refer to the operating instructions of the device for details.
<p>When connected by the USB cable, this unit is not detected by the other devices.</p>	<ul style="list-style-type: none"> ● When connected to other devices using only the battery, reconnect using the AC adaptor.
<p>VIERA Link does not work.</p>	<p>(Setting on this unit)</p> <ul style="list-style-type: none"> ● Connect with a HDMI mini cable. (→ 101) ● Touch MENU, then touch [SETUP] → [VIERA Link] → [ON]. (→ 101) ● Turn the unit off and then back on again. <p>(Setting on other devices)</p> <ul style="list-style-type: none"> ● If the TV input does not switch automatically, switch the input using the TV remote control. ● Check the VIERA Link setting on the connected device. ● Please refer to the operating instructions of the connected device.
<p>The power of the DVD burner cannot be turned on.</p>	<ul style="list-style-type: none"> ● When the unit is connected to the DVD burner, use the respective AC adaptors for both this unit and the DVD burner.
<p>Cannot copy scenes on the SD card by connecting to other equipment with the USB cable.</p>	<ul style="list-style-type: none"> ● Other equipment might have not recognised the SD card. Unplug the USB cable once, and reconnect it.

With a PC

Problem	Check points
When connected by the USB cable, this unit is not detected by the PC.	<ul style="list-style-type: none">● After re-inserting the SD card into the unit, reconnect the supplied USB cable.● Select another USB terminal on the PC.● Check the operating environment. (→ 127, 135)● Connect the supplied USB cable again after restarting the PC and turning on this unit again.
When the USB cable is disconnected, an error message will appear on the PC.	<ul style="list-style-type: none">● To disconnect the USB cable safely, double-click the  icon in the task tray and follow the instructions on the screen.
Cannot see the PDF operating instructions for HD Writer AE 4.0.	<ul style="list-style-type: none">● You will need Adobe Acrobat Reader 5.0 or later or Adobe Reader 7.0 or later to read the PDF operating instructions for HD Writer AE 4.0.

Others

Problem	Check points
If the SD card is inserted in this unit, it is not recognised.	<ul style="list-style-type: none">● If the SD card is formatted on a PC, it may not be recognised by this unit. Use this unit to format SD cards. (→ 37)

■ If AVCHD scenes do not change smoothly when played back on another device

The images may be still for several seconds at the joins between the scenes if the following operations are performed when multiple scenes have been continuously played back using another unit.

- Just how smoothly the scenes will be played back depends on the playback unit. Depending on the unit used, the images may stop moving and become still for a moment even when none of the following conditions are applicable.
- A continuous recording of motion picture data that exceeds 4 GB may momentarily stop at every 4 GB of data when played back with another device.
- It may not play back smoothly when the editing of scenes was done with the HD Writer AE 4.0, but it will play back smoothly if you set the seamless settings in the HD Writer AE 4.0. Refer to the operating instructions for the HD Writer AE 4.0.

Principal reasons for not playing back smoothly
● When the scenes were recorded on different dates
● When scenes lasting under 3 seconds have been recorded
● When PRE-REC was used for recording
● When deleting scenes
● When selected scenes are copied between an SD card and the built-in memory
● When selected scenes are copied to a disc in a connected DVD burner
● When scenes recorded more than 99 scenes on the same date

Cautions for use

About this unit

The unit and the SD card become warm during use. This is not a malfunction.

Keep this unit as far away as possible from electromagnetic equipment (such as microwave ovens, TVs, video games etc.).

- If you use this unit on top of or near a TV, the pictures and/or sound on this unit may be disrupted by electromagnetic wave radiation.
- Do not use this unit near cell phones because doing so may result in noise adversely affecting the pictures and/or sound.
- Recorded data may be damaged, or pictures may be distorted, by strong magnetic fields created by speakers or large motors.
- Electromagnetic wave radiation generated by microprocessors may adversely affect this unit, disturbing the pictures and/or sound.
- If this unit is adversely affected by electromagnetic equipment and stops functioning properly, turn this unit off and remove the battery or disconnect AC adaptor. Then reinsert the battery or reconnect AC adaptor and turn this unit on.

Do not use this unit near radio transmitters or high-voltage lines.

- If you record near radio transmitters or high-voltage lines, the recorded pictures and/or sound may be adversely affected.

Make sure to use the supplied cords and cables. If you use optional accessories,

use the cords and the cables supplied with them.

Do not extend the cords and the cables.

Do not spray insecticides or volatile chemicals onto the unit.

- If the unit is sprayed with such chemicals, its body may be marred and the surface finish may peel off.
- Do not leave rubber or plastic products in contact with the unit for a long time.

When you use the unit in a sandy or dusty place such as a beach, do not let sand or fine dust get into the body and terminals of the unit.

Also, keep the unit away from sea water.

- Sand or dust may damage the unit. (Care should be taken when inserting and removing a card.)
- If sea water splashes onto the unit, wipe off the water with a well wrung cloth. Then wipe the unit again with a dry cloth.

When carrying the unit, do not drop or bump it.

- A strong impact can break the unit's casing, causing it to malfunction.

Cleaning

- Before cleaning, detach the battery or pull the AC cable from the AC outlet, and then wipe the unit with a soft, dry cloth.
- If the unit is very dirty, dip a cloth in water and squeeze firmly, and then wipe the unit with the damp cloth. Next, dry the unit with a dry cloth.
- Use of benzine, paint thinner, alcohol, or dishwashing liquid may alter the camera body or peel the surface finish. Do not use these solvents.
- When using a chemical dust cloth, follow the instructions that came with the cloth.

Do not use the unit for surveillance purposes or other business uses.

- This unit was designed for consumer intermittent use. It was not intended for continuous use, or for any industrial or commercial application resulting in prolonged use.
- In certain situations, continuous use could cause the unit to overheat and cause a malfunction. Such use is strongly discouraged.

When you are not going to use the unit for an extended time

- When storing the unit in a cupboard or cabinet, it is recommended that you place a desiccant (silica gel) in with it.

HC-V700M

When disposing of or giving away this unit, note that:

- Formatting and deletion simply change the file management information and cannot be used to completely erase the data in built-in memory of this unit. The data can be recovered using commercially available software or the like.
- We recommend that you physically format the built-in memory before disposing of or giving away this unit.

To physically format the built-in memory, connect the unit via the AC adaptor, select [SETUP] → [FORMAT MEDIA] → [Built-inMemory] from the menu, and then press and hold the recording start/stop button on the screen below for about 3 seconds. When the built-in memory data deletion screen appears, select [YES], and then follow the on-screen instructions.

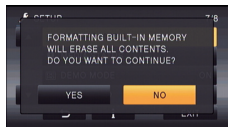

- Please look after the data in your built-in memory carefully. Panasonic will not be held responsible in the unlikely case that private data is divulged.

About the battery

The battery used in this unit is a rechargeable lithium-ion battery. It is susceptible to humidity and temperature and the effect increases the more the temperature rises or falls. In cold areas, the full charge indication may not appear or the low battery indication may appear about 5 minutes after starting use. At high temperatures, the protection function may be triggered, making it impossible to use the unit.

Be sure to detach the battery after use.

- If the battery is left attached, a minute amount of current continues to flow even if the unit is off. Keeping the unit in this state may result in over discharge of the battery. This may result in you not being able to use the battery even after it is charged.
- The battery should be stored in the vinyl bag so metal does not come into contact with the terminals.
- The battery should be stored in a cool place free from humidity, with as constant temperature as possible. (Recommended temperature: 15 °C to 25 °C, Recommended humidity: 40%RH to 60%RH)
- Extremely high temperatures or low temperatures will shorten the life of the battery.
- If the battery is kept in high-temperature, high-humidity, or oily-smoky places, the terminals may rust and cause malfunctions.
- To store the battery for a long period of time, we recommend you charge it once every year and store it again after you have completely used up the charged capacity.
- Dust and other matter attached to the battery terminals should be removed.

Prepare spare batteries when going out for recording.

- Prepare batteries enough to last for 3 to 4 times the period you are planning to record for. Cold places such as a ski resort can shorten recording time.

If you drop the battery accidentally, check to see if the terminals are damaged.

- Inserting a battery with damaged terminals can damage the unit.

Do not throw an old battery into fire.

- Heating a battery or throwing it into a fire may result in an explosion.

If the operating time is very short even after the battery has been recharged, the battery has worn out. Please purchase a new battery.

About the AC adaptor

- If the temperature of the battery is extremely high or extremely low, charging may take time or the battery may not be charged.
- If you use the AC adaptor near a radio, radio reception may be disturbed. Keep the AC adaptor 1 m or more away from the radio.
- When using the AC adaptor, it may generate whirring sounds. However, this is normal.
- After use, be sure to disconnect the AC adaptor. (If it is left connected, a minute amount of current is consumed.)
- Always keep the electrodes of the AC adaptor and battery clean.

About status indicator during charging

When the status indicator is flashing at a particularly fast or slow rate, the following should be considered.

Flashing with approx. 4 second period (off for approx. 2 seconds, on for approx. 2 seconds):

- When the battery is over discharged or the temperature of the battery is too high or low. It can be charged, but it may take a few hours to complete the charging normally.
- It will flash in approx. 2 second intervals when normal charging resumes. Even in such cases, it may start flashing in approx. 4 second intervals until charging is completed depending on the conditions of use.

Flashing with approx. 0.5 second period (off for approx. 0.25 second, on for approx. 0.25 second):

- The battery is not charged. Remove the battery from the unit, and try charging again.
- Check that the terminals of the unit or battery are not dirty or covered with a foreign object, and connect the battery correctly once again. If a foreign object or dirt is present, turn off the unit before removing.
- The battery or environment is at an extremely high or low temperature. Wait until the temperature has returned to an appropriate level and try charging again. If you are still unable to charge, there may be a fault in the unit, battery or AC adaptor.

Off:

- Charging has finished.
- If the status indicator stays off despite the charging being unfinished, there may be a fault in the unit, battery or AC adaptor. Refer to page 149 for details on the battery.

About 3D

About 3D recording

Attach the 3D Conversion Lens securely. It must not be used with an insecure attachment.

Do not use the 3D Conversion Lens without adjusting it first.

- It will not be possible to record 3D image correctly, and this may lead to tiredness or discomfort.
- When you re-attach the 3D Conversion Lens after removing it, we recommend making the adjustments again.

With the 3D Conversion Lens attached, do not record a subject at less than the minimum focus distance.

- The 3D effects may be more pronounced, and therefore cause tiredness or discomfort.
- The minimum focus distance is approx. 1.2 m.

When recording with the 3D Conversion Lens attached, be careful not to shake the unit.

- Tiredness or discomfort may result if the shake is pronounced, due to riding in a vehicle or walking etc.
- When moving the unit as you record, move it slowly.
- We recommend using a tripod.

About 3D viewing

Anyone who is hyper sensitive to light, suffers from heart disease or is otherwise unwell should avoid viewing 3D image.

- Doing may have an adverse affect on such medical conditions.

If you feel tired, uncomfortable or otherwise strange when viewing 3D image, stop viewing at once.

- Continuing to view may cause illness.
- Please rest appropriately after stopping the viewing.

When viewing 3D image, we recommend taking a break every 30 to 60 minutes.

- Viewing for extended periods may cause eye-fatigue.

Short-sighted or far-sighted persons, those with differences in the sight of their right and left eyes, and those with astigmatism are advised to correct their vision by wearing glasses etc.

Stop viewing if you can clearly see a double image while viewing 3D image.

- There are differences in the way that different people experience 3D images. Please correct your sight appropriately before viewing 3D image.
- You can change the 3D setting of your television or 3D output setting of the unit to 2D.

About the SD card

When disposing of or giving away the SD card, note that:

- Formatting and deletion of this unit or computer only changes the file management information and does not completely delete the data in the SD card.
- It is recommended that the SD card is physically destroyed or the SD card is physically formatted using this unit when disposing of or giving away the SD card.

HC-V700

To physically format the SD card, connect the unit via the AC adaptor, select [SETUP] → [FORMAT CARD] → [YES] from the menu, and then press and hold the recording start/stop button on the screen below for about 3 seconds. When the SD card data deletion screen appears, select [YES], and then follow the on-screen instructions.

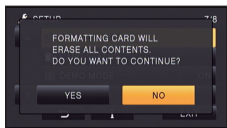

HC-V700M

To physically format the SD card, connect the unit via the AC adaptor, select [SETUP] → [FORMAT MEDIA] → [SD CARD] from the menu, and then press and hold the recording start/stop button on the screen below for about 3 seconds. When the SD card data deletion screen appears, select [YES], and then follow the on-screen instructions.

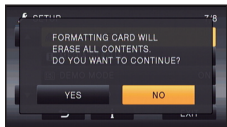

- The customer is responsible for the management of the data in the SD card.

LCD monitor

- When the LCD monitor gets dirty, wipe it with a soft cloth, such as eye glass cleaner.
- Do not touch the LCD monitor with your finger nails, or rub or press with strong force.
- It may become hard to see or hard to recognise the touch when the LCD protection sheet is affixed.
- In a place with drastic temperature changes, condensation may form on the LCD monitor. Wipe it with a soft cloth, such as eye glass cleaner.
- When the unit has become very cold, for example due to storage in a cold area, its LCD monitor will be slightly darker than usual immediately after the unit is turned on. The normal brightness will be restored when the unit's internal temperature rises.

Extremely high precision technology is employed to produce the LCD Monitor screen featuring a total of approximately 460,000 dots. The result is more than 99.99% effective dots with a mere 0.01% of the dots inactive or always lit. However, this is not a malfunction and does not affect the recorded picture.

About personal information

After you have set up the Face Recognition function, personal information will be held in this unit and included in recorded images.

- When the unit is serviced, or given away/ disposed of, the personal information should be deleted in the interests of protecting personal information. (→ 94)

Indemnity

- Information, including personal information, may be changed or lost as a result of mistaken operation, static electricity effects, accident, breakage, repair or other handling.

It should be noted before use that Panasonic does not accept any responsibility for direct or indirect problems which occur as the result of the change to or loss of the information including personal information.

About condensation

When condensation forms on the unit, the lens will cloud up and the unit may not work properly. Make every effort to ensure that condensation does not form. If it does form, take the actions described below.

Causes of condensation

Condensation takes place when the ambient temperature or humidity is changed as follows.

- When this unit is brought inside from the cold (e.g. a ski slope) to a warm room.
- When this unit is moved from an air-conditioned car to outside.
- When a cold room has been warmed up quickly.
- When cool wind from an air conditioner is directly blown onto this unit.
- After rain showers.
- When this unit is in a very humid place where the air is thick with steam. (e.g. a heated swimming pool)

Helpful hint

If, for example, you have used this unit for recording on a ski slope and are taking it into a heated room, place the unit inside a plastic bag, remove as much of the air from inside the bag as possible, then seal the bag.

Leave the unit for about an hour in the room so the temperature of the unit is close to the ambient temperature of the room, then use it.

About copyright

■ Carefully observe copyright laws

Recording of pre-recorded tapes or discs or other published or broadcast material for purposes other than your own private use may infringe copyright laws. Even for the purpose of private use, recording of certain material may be restricted.

■ Licenses

- SDXC Logo is a trademark of SD-3C, LLC.
- “AVCHD”, “AVCHD Progressive” and the “AVCHD Progressive” logo are trademarks of Panasonic Corporation and Sony Corporation.
- Manufactured under license from Dolby Laboratories. Dolby and the double-D symbol are trademarks of Dolby Laboratories.
- HDMI, the HDMI Logo, and High-Definition Multimedia Interface are trademarks or registered trademarks of HDMI Licensing LLC in the United States and other countries.
- HDAVI Control™ is a trademark of Panasonic Corporation.
- x.v.Colour™ is a trademark.
- Microsoft®, Windows® and Windows Vista® are either registered trademarks or trademarks of Microsoft Corporation in the United States and/or other countries.
- Microsoft product screen shot(s) reprinted with permission from Microsoft Corporation.
- IBM and PC/AT are registered trademarks of International Business Machines Corporation of the U.S.
- Intel®, Pentium®, Celeron® and Intel®Core™ are trademarks of Intel Corporation in the U.S. and/or other countries.
- AMD Athlon™ is a trademark of Advanced Micro Devices, Inc.
- iMovie, Mac and Mac OS are trademarks of Apple Inc. registered in the U.S. and other countries.
- NVIDIA and 3D VISION are either registered trademarks or trademarks of NVIDIA Corporation in the United States and/or other countries.
- Other names of systems and products mentioned in these instructions are usually the registered trademarks or trademarks of the manufacturers who developed the system or product concerned.

This product is licensed under the AVC patent portfolio license for the personal and non-commercial use of a consumer to (i) encode video in compliance with the AVC Standard (“AVC Video”) and/or (ii) decode AVC Video that was encoded by a consumer engaged in a personal and non-commercial activity and/or was obtained from a video provider licensed to provide AVC Video. No license is granted or shall be implied for any other use. Additional information may be obtained from MPEG LA, LLC. See <http://www.mpegla.com>.

Recording modes/approximate recordable time

- SD cards are only mentioned with their main memory size. The stated times are the approximate recordable times for continuous recording.

Recording mode		[1080/50p]	[1080/50i]			
			[HA]	[HG]	[HX]	[HE]
Picture size/ Frame rate		1920×1080/ 50p	1920×1080/ 50i	1920×1080/ 50i	1920×1080/ 50i	1920×1080/ 50i
SD card	4 GB	19 min	30 min	40 min	1 h	1 h 30 min
	16 GB	1 h 20 min	2 h	2 h 40 min	4 h 10 min	6 h 40 min
	64 GB	5 h 20 min	8 h 30 min	11 h	16 h 50 min	27 h 30 min
HC-V700M Built-in memory	16 GB	1 h 20 min	2 h	2 h 40 min	4 h 10 min	6 h 40 min

- A** Favours image quality
B Favours Recording time

Recording mode		[iFrame]	[SbS 3D]
Picture size/ Frame rate		960×540/ 25p	1920×1080/ 50i
SD card	4 GB	19 min	30 min
	16 GB	1 h 20 min	2 h
	64 GB	5 h 20 min	8 h 30 min
HC-V700M Built-in memory	16 GB	1 h 20 min	2 h

- If recording for long periods, prepare batteries for 3 or 4 times the period you wish to record for. (→ 11)
- The default setting is [HG] Mode.
- Maximum continuously recordable time for one scene: 6 hours
- The recording is paused once when the recording time for one scene exceeds 6 hours, and the recording will automatically resume after a few seconds.
- The recordable time may be reduced if recording with a lot of action is recorded or recording of short scene is repeated.
- Use time in the row of 4 GB in above table as a guideline for the time that can be copied onto one DVD disc (4.7 GB).

Approximate number of recordable pictures

- SD cards are only mentioned with their main memory size. The stated number is the approximate number of recordable pictures.

Picture size		5.1M 2848×2136	2.3M 1760×1320	0.3M 640×480	
Aspect ratio		4:3			
SD card	4 GB	1100	2800	28000	
	16 GB	4700	11500	118000	
	64 GB	18500	47000	475000	
HC-V700M Built-in memory		16 GB	4700	11500	118000

Picture size		6.1M 3024×2016	2.3M 1872×1248	5.8M 3200×1800	2.1M 1920×1080	
Aspect ratio		3:2		16:9		
SD card	4 GB	1100	2800	1200	3100	
	16 GB	4700	11500	5000	13000	
	64 GB	18500	47000	20000	52000	
HC-V700M Built-in memory		16 GB	4700	11500	5000	13000

When recording 3D still pictures

Picture size		2.1M 1920×1080	
Aspect ratio		16:9	
SD card	4 GB	1000	
	16 GB	4300	
	64 GB	17500	
HC-V700M Built-in memory		16 GB	4300

- The number of recordable pictures depends on the subject being recorded.
- When recording a 3D still picture, the equivalent 2D still picture is recorded as well; therefore, the number of recordable pictures will be reduced accordingly.
- Maximum number of recordable pictures that can be displayed is 9999. If the number of recordable pictures exceeds 9999, R 9999+ is displayed. The number will not change when the picture is taken until the number of recordable pictures is 9999 or less.
- The memory capacity indicated on the label of an SD card is the total of the capacity for copyright protection and management and the capacity which can be used on the unit, a PC etc.

Optional accessories

■ Attaching the supplied shoe adaptor

Insert the shoe adaptor into the shoe adaptor mounting part.

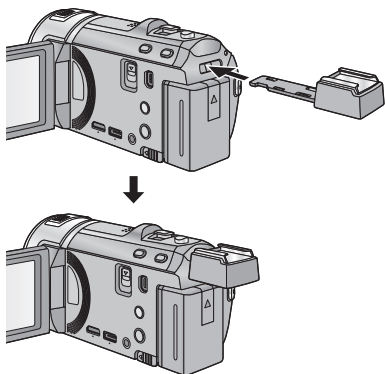

When removing the shoe adaptor, slide the SHOE ADAPTOR RELEASE lever, and remove the shoe adaptor while sliding the lever.

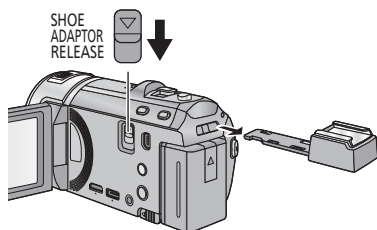

■ Attaching the conversion lens/ filter kit

Attach the wide conversion lens (VW-W4907H: optional) ND filter or MC protector of the Filter kit (VW-LF46NE: optional) in front of the lens.

- You will not be able to use the flash. Set the flash setting to ☒ ([OFF]). (→ 50)

Be careful about the following.

When 2 lens accessories, such as the ND filter and wide conversion lens, are fitted and the zoom lever is pressed toward the W side, the 4 corners of an image will be darkened. (Vignetting)

Attaching the lens cap of the Filter Kit (VW-LF46NE: optional)

- When the filter kit (VW-LF46NE: optional) is used, protect the lens surface while the unit is not used with the lens cap supplied with the filter kit.

Panasonic Corporation
Web site: <http://panasonic.net>